

MAKING HISTORY



Click boards™

MIKROE

THE BIGGEST ADD-ON BOARD COLLECTION IN THE WORLD.

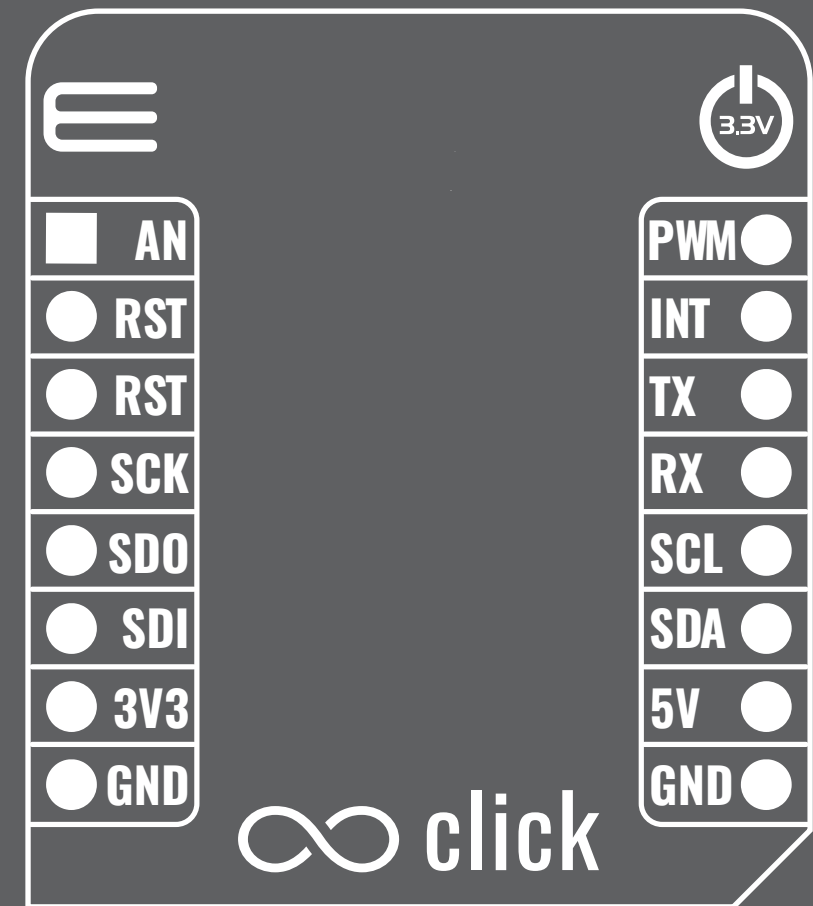

**Shape the future of
the embedded world
with our time-saving
development tools.**

MIKROE

Table of contents

From one man's idea to a dominant add-on board standard	6
New Click boards™ release per year	12
World's biggest add-on board collection – Click boards™	14
Wireless connectivity	15
Sensors	29
Interface	67
Display & LED	81
HMI	89
Storage	97
Miscellaneous	103
Motor Control	109
Audio & Voice	117
Mixed Signal	123
Power Management	133
Clock & Timing	143
Everything under one roof	151
Growing with our partners	154
Clicking on all platforms	156
∞	158

All the information and images shown in this catalog are for illustration purposes only, and may not be the exact representation of the products. Actual products may vary due to products enhancement. MikroE reserves the right to change product images and specifications at any time without notice.

From one man's idea to a dominant add-on board standard

The entire company works towards a shared vision – to save time of our fellow engineers. Click boards™ product line constitutes a key component of the future we have envisioned.

Development boards are substantially similar: they integrate a microcontroller, power supply, tact switches, LEDs, pins. The features that differentiate development boards are the peripherals such as UART, 7-seg digits, RTC, Relay, ADC, EPROM, and the like. Different projects, however, require that a different peripheral be used each time. If peripherals on a single board could be changed, its functionality would improve significantly.

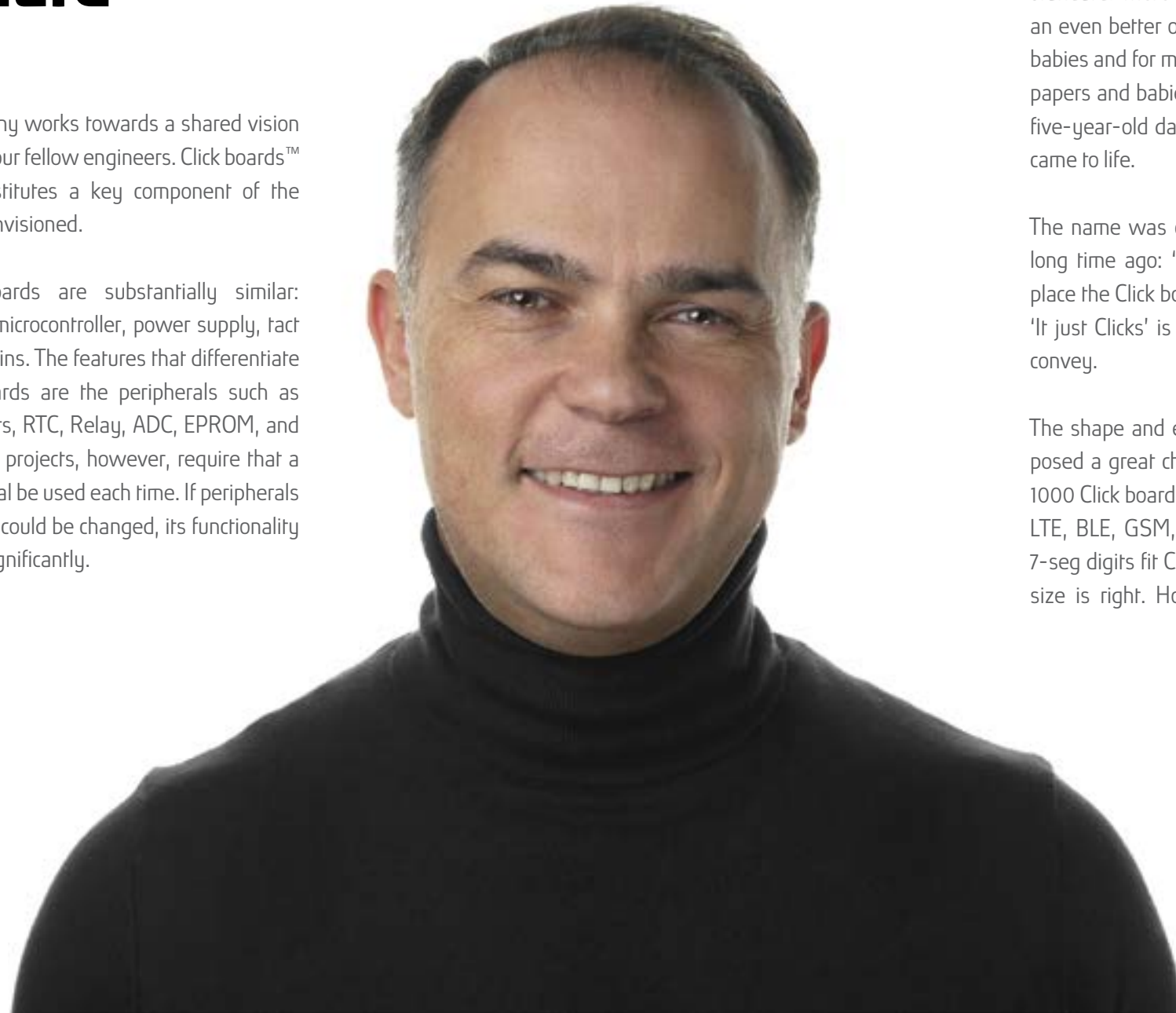

Presented with the problem, I started looking for a solution: how to change peripherals easily and what to add to a board to be able to do so.

I remember the very moment when I hit upon the idea of the mikroBUS™ standard – the very first drawing of it I made in the sand and later on a piece of paper. In fact, my family was on holiday in a hotel – Hillside – Su – in Antalya (Turkey), and the hotel played a key role in the story of mikroBUS™ standard: there was a play area for children and an even better one – in the shade and roomy – for babies and for my papers and data-sheet. Amid the papers and babies, as I was keeping an eye on my five-year-old daughter Lena, mikroBUS™ standard came to life.

The name was chosen by one of my colleagues a long time ago: 'click' is what you hear when you place the Click board™ onto the development board. 'It just Clicks' is a marketing message we wish to convey.

The shape and end-dimension of the Click board™ posed a great challenge. Now that we have made 1000 Click boards™, it is easy to notice that all WiFi, LTE, BLE, GSM, GPS modules, OLED screen, and 7-seg digits fit Click boards™ perfectly, and that the size is right. However, dimension check requires

that the components and modules classification on a single Click board™ be reviewed and several hundred datasheets be opened. I take pride in our solution: this part of the Click boards™ story looks like a simple task; however, without it, there would be a great decrease in the number of Click boards™ created.

Back at work, I called a meeting and presented my idea: I spoke about the pins I chose and why I chose those very pins; I explained what the overarching goal was and provided other relevant information. It was in that meeting that we revised the statement and increased the functionality of the mikroBUS™ standard by adding a few more pins, so that there was a total of 16 pins – 8 in each row. We now know that this is by far the smallest number of the pins one can use and which account for most chips, modules, and other components you could place on Click board™.

1000 Click boards™ is a huge milestone since not a single company in our industry has that number of peripheral boards.. We made history in reaching that number. More importantly, the mikroBUS™ standard has proven to be very usable: if you can design 1000 different Click boards™ on one standard and create another thousand and then another thousand, that means that the standard is quite exceptional.

A handwritten signature in black ink, appearing to read 'Nebojsa Matic'.

Nebojsa Matic,
CEO

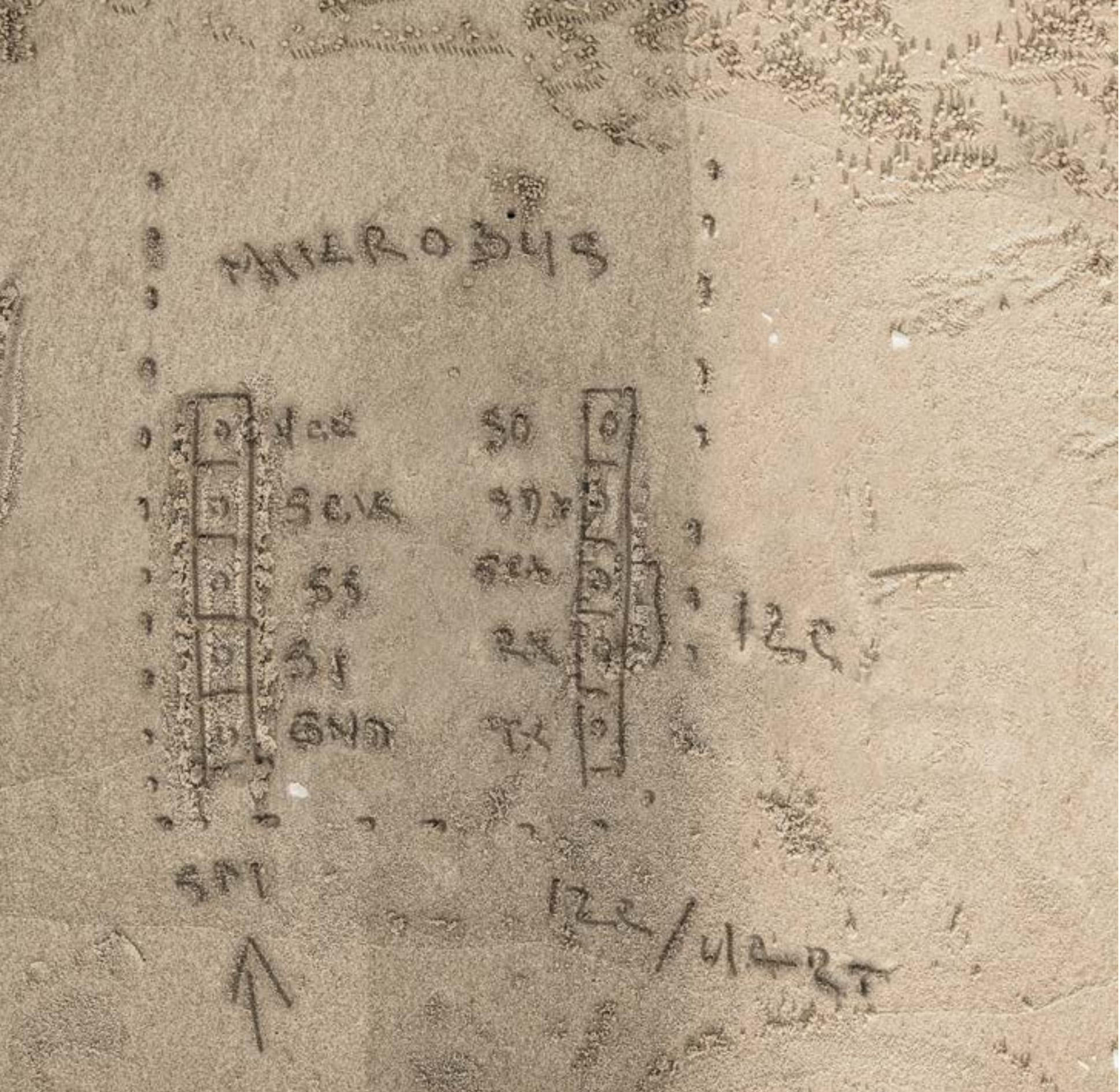

What is the minimum number of pins that can cover the greatest number of peripherals?

The first sketch of the mikroBUS™ standard drawn in 2011.

st

GPS Click

It carries LEA-6S high-performance position engine from u-blox.

MSRP - \$49⁰⁰
MIKROE-1032

The first-ever mikroBUS™ compatible add-on board was made in 2011. With this board, we presented a new product line called Click boards™.



New Click boards™ release per year

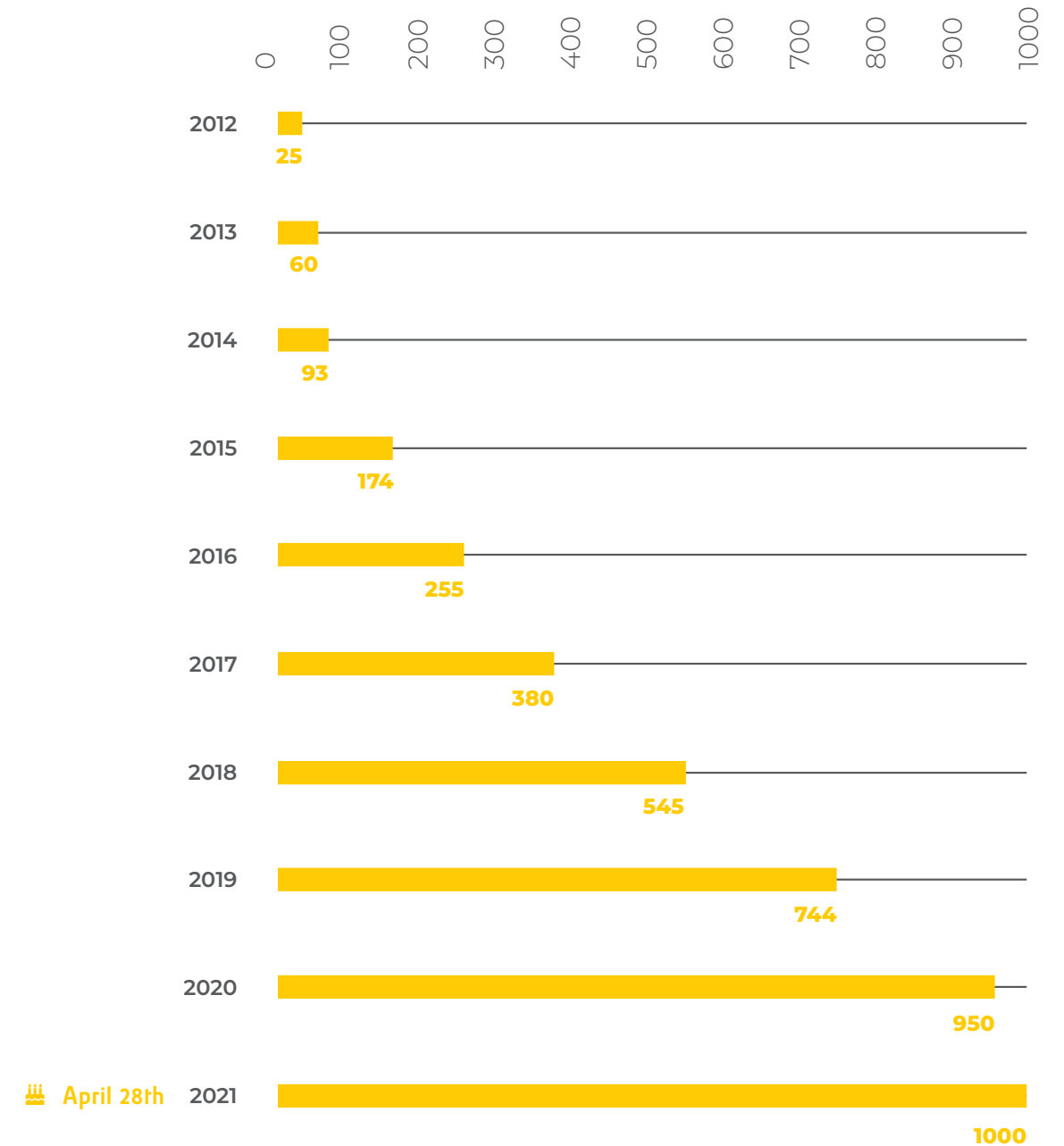
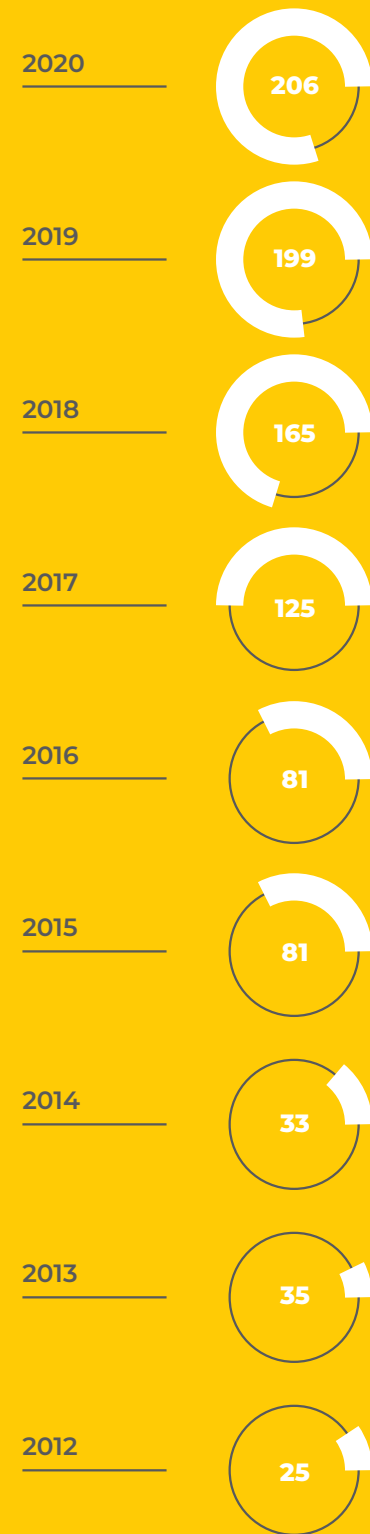

Number of Click boards™ at the end of the year

**World's
biggest
add-on board
collection
– Click boards™**

**WIRELESS
CONNECTIVITY**



3G Click (USA)

UG95 3G UMTS/HSPA module. With SIM card slot, Audio/Mic jack, micro USB port.

MSRP - \$89⁰⁰
MIKROE-2296



3G Click (EU/AUS)

UG95 3G UMTS/HSPA module. With SIM card slot, Audio/Mic jack, micro USB port.

MSRP - \$89⁰⁰
MIKROE-2226



3G SARA Click

With UMTS/HSPA cellular modem - the u-blox U201, from the SARA series.

MSRP - \$99⁰⁰
MIKROE-2244



4G LTE-E Click

With the LARA-R211 multi-mode cellular module from u-blox.

MSRP - \$115⁰⁰
MIKROE-2527



4G LTE-NA Click

It features the LARA-R204 multi-mode cellular module from u-blox.

MSRP - \$115⁰⁰
MIKROE-2535



BLE 2 Click

With RN4020 Bluetooth 4.1 module. Can be set up both as a client or a server.

MSRP - \$30⁰⁰
MIKROE-1715



BLE 3 Click

It features NI-NA-B1 Bluetooth 4.2 module from u-blox.

MSRP - \$39⁰⁰
MIKROE-2471



BLE P Click

With nRF8001 Bluetooth 4.0 peripheral device. Open source Android app available.

MSRP - \$25⁰⁰
MIKROE-1597



Bluetooth Click

It features the RN-41 low power, class 1 Bluetooth radio module.

MSRP - \$39⁰⁰
MIKROE-958



BT Audio Click

With RN52 Bluetooth audio module and on-board 3.5mm jacks for a mic and a speaker.

MSRP - \$49⁰⁰
MIKROE-2399





6LoWPAN C Click
TI's CC2520, 2.4GHz ZigBee®/IEEE 802.15.4 RF transceiver.

MSRP - \$26⁰⁰
MIKROE-2219



6LoWPAN T Click
TI's CC2520, 2.4GHz ZigBee®/IEEE 802.15. RF transceiver.

MSRP - \$26⁰⁰
MIKROE-2218



BEE Click
Microchip's MRF24J-40MA 2.4 GHz IEEE 802.15.4 radio transceiver module.

MSRP - \$29⁰⁰
MIKROE-987



GNSS Click
Quectel's L86 GNSS module with a patch antenna and an external antenna connector.

MSRP - \$46⁰⁰
MIKROE-1850



GNSS 2 Click
Quectel's L76 module and SMA antenna connector. GPS + GLONASS.

MSRP - \$39⁰⁰
MIKROE-1887



GNSS 3 Click
Carries SIM33ELAGNSS module with an integrated antenna and an external antenna connector.

MSRP - \$39⁰⁰
MIKROE-1895



GNSS 4 Click
It features SAM-M8Q patch antenna module from u-blox.

MSRP - \$44⁰⁰
MIKROE-2045



GNSS 5 Click
It features NEO-M8N GNSS receiver module from u-blox.

MSRP - \$41⁰⁰
MIKROE-2670



GPS Click
It carries LEA-6S high-performance position engine from u-blox.

MSRP - \$49⁰⁰
MIKROE-1032



GPS 3 Click
With Quectel's L80, high-sensitivity GPS module with a patch antenna.

MSRP - \$44⁰⁰
MIKROE-1714



ccRF Click
With CC2500 low-power 2.4 GHz RF transceiver and PCB trace antenna.

MSRP - \$22⁰⁰
MIKROE-1435



ccRF 2 Click
With CC1120, high performance radio transceiver for ISRM and SRD bands.

MSRP - \$36⁰⁰
MIKROE-1716



ccRF 3 Click
Carries the CC1120 high-performance RF transceiver for narrow-band systems from TI.

MSRP - \$36⁰⁰
MIKROE-2389



GSM Click
With quad-band GL865-QUAD GSM/GPRS module, onboard antenna connector and SIM card socket.

MSRP - \$49⁰⁰
MIKROE-1298



GSM 2 Click
With Quectel's M95 FA quad-band GSM/GPRS module. 85.6 kbps GPRS data transfer.

MSRP - \$44⁰⁰
MIKROE-1375



GSM 3 Click
With SIM800H quad-band GSM/GPRS module. 85.6 kbps GPRS data transfer.

MSRP - \$57⁰⁰
MIKROE-1720



GSM/GNSS Click
Quectel's MC60 quad-band GSM/GPRS/GNSS module. GPS/GNSS location tracking with GSM.

MSRP - \$79⁰⁰
MIKROE-2439



GSM/GNSS 2 Click
With SIM868 quad-band GSM/GPRS module. GPS/GNSS location tracking with GSM.

MSRP - \$69⁰⁰
MIKROE-2440



iQRF Click
With DCTR-76DA RF transceiver, operating in the 868/916 MHz frequency.

MSRP - \$43⁰⁰
MIKROE-2586



iQRF 2 Click
With DCTR-72DAT RF transceiver, operating in the 868/916 MHz frequency.

MSRP - \$49⁰⁰
MIKROE-2587





LR Click

With RN2483 LoRa Sub-GHz, 433/868 MHz European R&TTE Directive Assessed Radio Modem.

MSRP - \$39⁰⁰
MIKROE-4470



LR 2 Click

With RN2903 915 MHz Radio Modem compliant with regulations for use in the USA, CA, AU, NZ.

MSRP - \$39⁰⁰
MIKROE-4615



LR 3 Click

A LoRa technology-based SRD transceiver, operates at a sub-gigahertz frequency of 868MHz.

MSRP - \$45⁰⁰
MIKROE-4616



LR 4 Click

A LoRa RF technology based SRD transceiver, operates at a sub-GHz frequency of 868MHz.

MSRP - \$45⁰⁰
MIKROE-2934



LR 5 Click

SRD transceiver which operates at a sub-GHz frequency of 902-928 MHz SRD Band.

MSRP - \$45⁰⁰
MIKROE-4618



NFC Tag Click

With M24SR64 NFC/RFID tag IC with a dual interface and 8KB of high-reliability EEPROM built-in.

MSRP - \$12⁰⁰
MIKROE-1726



NFC Tag 2 Click

Carries NT3H1101 NTAG I2C energy harvesting NFC Forum Type 2 Tag from NXP.

MSRP - \$12⁰⁰
MIKROE-2462



tRF Click

With Telit's LE70-868 - a 868 MHz transceiver module with embedded stack.

MSRP - \$59⁰⁰
MIKROE-1535



LTE IoT 5 Click

Features the SARA-R510M8S cellular module from u-Blox.

MSRP - \$79⁰⁰
MIKROE-4325



LTE IoT 6 Click

The SARA-R412M, a cellular module for Low Power Wide Area solutions from u-Blox.

MSRP - \$79⁰⁰
MIKROE-4388



GSM-GPS Click

With SIM808, GSM/GPRS and GPS module. 2 antenna conn. SIM card slot, a micro USB conn.

MSRP - \$85⁰⁰
MIKROE-2382



nRF C Click

With nRF24L01P 2.4 GHz transceiver. Air data rates of 250 Kbps, 1 Mbps and 2 Mbps.

MSRP - \$19⁰⁰
MIKROE-1304



nRF S Click

With nRF24L01P 2.4 GHz transceiver. 250 Kbps, 1 Mbps and 2 Mbps air data rates.

MSRP - \$19⁰⁰
MIKROE-1836



nRF T Click

With nRF24L01P 2.4 GHz transceiver module. Air data rates of 250 Kbps, 1 Mbps and 2 Mbps.

MSRP - \$16⁰⁰
MIKROE-1305



RFid Click

With CR95HF 13.56 MHz contactless RFid transceiver, and trace antenna.

MSRP - \$29⁰⁰
MIKROE-1434



NFC Click

With near field communications controller PN7120 IC from NXP.

MSRP - \$34⁰⁰
MIKROE-2395



RN4678 Click

It carries RN4678 Bluetooth® 4.2 dual mode module from Microchip.

MSRP - \$29⁰⁰
MIKROE-2545



RN4870 Click

It carries RN4870 Bluetooth® 4.2 low energy module from Microchip.

MSRP - \$33⁰⁰
MIKROE-2543



RN4871 Click

It carries RN4871 Bluetooth® 4.2 low energy module from Microchip.

MSRP - \$33⁰⁰
MIKROE-2544



WiFi PLUS Click

With MRF24WB-OMA 2.4GHz, IEEE std. 802.11 module and MCW1001 controller.

MSRP - \$45⁰⁰
MIKROE-1135





WiFi 2 Click
With HLK-M30 module. Can be set up with either a static or dynamic IP address.
MSRP - \$29⁰⁰
MIKROE-1768



WiFi 3 Click
With ESP8266 module. TCP/IP stack. Supports Wi-Fi Direct (p2p). 6 GPIO pins.
MSRP - \$27⁰⁰
MIKROE-1769



WiFi 4 Click
With SPWF01SA standalone WiFi module. Built-in 2.45 GHz ISM band antenna.
MSRP - \$49⁰⁰
MIKROE-1913



WiFi 5 Click
With Gainspan's GS1500M 802.11b/g/n Low Power Wi-Fi module with a PCB trace antenna.
MSRP - \$29⁰⁰
MIKROE-2274



WiFi 6 Click
With WF121-A self-contained WiFi module. 2.4GHz band IEEE 802.11 b/g/n radio.
MSRP - \$69⁰⁰
MIKROE-2043



WiFi 7 Click
With ATWINC1510-MR210PB IEEE 802.11 b/g/n module, 20MHz solution.
MSRP - \$29⁰⁰
MIKROE-2046



WiFi ESP Click
With ESP-WROOM-02 module that integrates ESP8266EX. In AP WiFi and WiFi client mode.
MSRP - \$15⁰⁰
MIKROE-2542



MiWi Click
A subgigahertz radio transceiver which offers a reliable FSK or OOK communication solution.
MSRP - \$17⁰⁰
MIKROE-2924



MiWi 2 Click
A subgigahertz radio transceiver which offers a reliable FSK or OOK communication solution.
MSRP - \$17⁰⁰
MIKROE-2925



M-BUS RF Click
With ME70-169 RF wireless module. Unlicensed ISM frequency band 169.400-169.475 MHz.
MSRP - \$54⁰⁰
MIKROE-2048



WiFly Click
With RN-131 embedded wireless LAN module. Qualified 2.4-GHz IEEE 802.11 b/g transceiver.
MSRP - \$69⁰⁰
MIKROE-1937



AnyNet 2G Click
WiFi module with integrated IPv4 TCP/IP stack and built-in network protocols.
MSRP - \$69⁰⁰
MIKROE-2747



AnyNet 3G-EA Click
A secure connection with the AWS over the air (OTA), by utilizing the Quectel UG95 3G module.
MSRP - \$89⁰⁰
MIKROE-2975



CC3100 Click
Carries low power, high security Wi-Fi CC3100 module. Support for 802.11n.
MSRP - \$49⁰⁰
MIKROE-2336



OOK RX Click
A wireless receiver that operates at the frequency of 433MHz (sub-GHz).
MSRP - \$19⁰⁰
MIKROE-2902



OOK TX Click
A wireless transmitter that operates at the frequency of 433MHz (sub-GHz).
MSRP - \$19⁰⁰
MIKROE-2903



WiFi NINA Click
A standalone WiFi module, with the state-of-the-art NINA-W132 module from u-blox.
MSRP - \$45⁰⁰
MIKROE-2921



NB IoT Click
Allows LTE Cat NB1 connectivity by utilizing Quectel BC95-G
MSRP - \$52⁰⁰
MIKROE-3294



LTE IoT Click
Compact quad-band GSM solution, featuring the quad-band SARA-R410M-02B LTE/2G module.
MSRP - \$79⁰⁰
MIKROE-3072



LTE IoT 2 Click
Allows connection to the LTE networks, featuring Quectel BG96 LTE module.
MSRP - \$69⁰⁰
MIKROE-3144





SPIRIT Click

With SP1ML 868MHz ultra low-power RF module. Memory: 16 kB RAM and 128 kB Flash.

MSRP - \$39⁰⁰
MIKROE-2568



XBEE Click

Xbee® and Zigbee-compliant XB-24CZ7PIS-004 module with a PCB antenna.

MSRP - \$59⁰⁰
MIKROE-1599



NANO GPS Click

With Nano Hornet, world's smallest GPS module with an integrated antenna.

MSRP - \$45⁰⁰
MIKROE-1912



GPS 4 Click

GPS 4 click carries the L70 compact GPS module from Quectel, with external antenna.

MSRP - \$34⁰⁰
MIKROE-2704



GSM 4 Click

Compact quad-band GSM solution, featuring the quad-band SARA-G350 module.

MSRP - \$74⁰⁰
MIKROE-2388



EnOcean 3 Click

With ultra-low power TCM515 transceiver gateway module and operates at 868MHz radio band.

MSRP - \$39⁰⁰
MIKROE-3653



BLE 8 Click

With the ANNA-B112, an ultra-small, stand-alone Bluetooth low energy module.

MSRP - \$29⁰⁰
MIKROE-3674



WiFi 9 Click

With the PAN9420 a 2.4 GHz ISM band Wi-Fi-embedded module.

MSRP - \$45⁰⁰
MIKROE-3666



WiFi 10 Click

Based on the SX-ULPAN-SB-2401, an integrated wireless LAN module.

MSRP - \$25⁰⁰
MIKROE-3432



WiFi BLE Click

The ESP32-WROOM-32 module itself is based on the ESP32-D0WDQ6 chip, a powerful 32-bit SOIC.

MSRP - \$21⁰⁰
MIKROE-3542

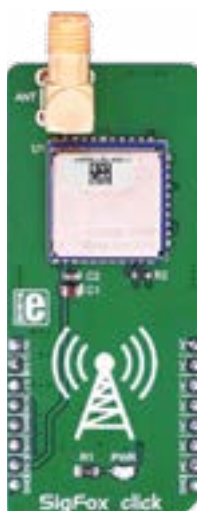

SigFox Click

Carries the SN10-11, a fully integrated Sigfox™ certified module by InnoComm.

MSRP - \$25⁰⁰
MIKROE-3034



SigFox 2 Click

Carries the SN10-12, a fully integrated Sigfox™ certified module by InnoComm.

MSRP - \$25⁰⁰
MIKROE-3039



SigFox 3 Click

Carries the SN10-13, a fully integrated Sigfox™ certified module by InnoComm.

MSRP - \$25⁰⁰
MIKROE-3163



EnOcean 4 Click

With ultra-low power TCM515U transceiver gateway module which operates at 920MHz radio band.

MSRP - \$39⁰⁰
MIKROE-3637



DeviceDrive Click

The WRF01-M24A module uses the UART interface [with JSON command format].

MSRP - \$19⁰⁰
MIKROE-3663



Nano LR Click

The EMB-LR1276S, a sub-1GHz wireless module that supports the LoRaWANTM®.

MSRP - \$39⁰⁰
MIKROE-4514



G2C Click

A gateway Click board™ which provides a simple and reliable connection to the Click Cloud platform.

MSRP - \$19⁰⁰
MIKROE-3291



4G LTE-APJ Click

LTE Cat 1 / UMTS multimode-decellular network solution, with the compact LARA-R2 series modem from u-blox.

MSRP - \$115⁰⁰
MIKROE-3351



4G LTE-AT&T Click

LTE Cat 1 / UMTS multimode-decellular network solution, with the compact LARA-R2 series modem from u-blox.

MSRP - \$115⁰⁰
MIKROE-3350



GNSS 7 Click

It carries the NEO-M9N GNSS receiver module from u-blox.

MSRP - \$39⁰⁰
MIKROE-1887





GNSS ZOE Click
An evaluation board for ultra small ZOE-M8Q GNSS SIP receiver from u-blox.

MSRP - \$39⁰⁰
MIKROE-3660



NFC Tag 4 Click
NFC tag device, offering 16 Kbit of electrically erasable programmable memory [EEPROM].

MSRP - \$12⁰⁰
MIKROE-3659



SPIRIT 2 Click
With the SP1ML-915, an ultra-low power RF module, which operates at 915 MHz ISM band.

MSRP - \$39⁰⁰
MIKROE-3598



BLE 4 Click
It features the NINA-B312, an integrated wireless connectivity solution.

MSRP - \$29⁰⁰
MIKROE-3773



BLE 7 Click
Based on the BGX-13S22GA, a bluetooth low energy module from Silicon Labs.

MSRP - \$21⁰⁰
MIKROE-3872



M-BUS RF 4 Click
With a Telit ME70-169 RF wireless module.

MSRP - \$54⁰⁰
MIKROE-3692



Thingstream Click
It is equipped with the SIM868, an 802.11b/g/n quad-band GPS/GLONASS/GSM module.

MSRP - \$45⁰⁰
MIKROE-3739



NFC Extend Click
Uses any shape and size external antenna, with 16 Kbit of EEPROM.

MSRP - \$6⁰⁰
MIKROE-3971



5G NB IoT Click
Based on Thales ENS22 NB-IoT Wireless Module that boosts highly efficient 5G conn. for the IoT.

MSRP - \$59⁰⁰
MIKROE-4034



BT-EZ Click
It features the CYBT-343026-01, module that supports BT 5.0 and BLE stack.

MSRP - \$25⁰⁰
MIKROE-4038



G2C 3G Click
Allows connection to the feature-rich Click Cloud platform, over the 3.75G UMTS/HSPA network.

MSRP - \$69⁰⁰
MIKROE-3888



LTE Cat. 1-EU Click
Carries the ELS61 Cat 1 LTE connectivity module with 2G and 3G fall back.

MSRP - \$105⁰⁰
MIKROE-3757



LTE Cat. 1-US Click
Carries the ELS61 Cat 1 LTE connectivity module with 2G and 3G fall back.

MSRP - \$105⁰⁰
MIKROE-3885



BLE 5 Click
Based on the PA-N1760A, a Bluetooth 4.2 low energy module from Panasonic.

MSRP - \$26⁰⁰
MIKROE-4120



BT Audio 2 Click
Bluetooth audio stream add on board based on BM62 module from Microchip.

MSRP - \$45⁰⁰
MIKROE-4117



Nano GPS 2 Click
The smallest GPS module with an integrated patch antenna, the ORG1510-MK05 by OriginGPS.

MSRP - \$45⁰⁰
MIKROE-4150



BLE 6 Click
It's compliant with BT specifications v5.0 and BQE qualified.

MSRP - \$21⁰⁰
MIKROE-4170



UWB Click
The DWM1000 module based on Decawave's DW1000 Ultra-Wide-band [UWB] transceiver.

MSRP - \$69⁰⁰
MIKROE-4199



LTE IoT 3 Click
Features the EXS82-W, LTE-IoT Wireless Module from Thales.

MSRP - \$79⁰⁰
MIKROE-4118



ZigBee Click
Features the ETRX357, 2.4 GHz Zigbee Radio module from Silicon Labs.

MSRP - \$49⁰⁰
MIKROE-4277





Bluetooth 2 Click

With a WT41u, a long range class 1, Bluetooth® 2.1 + EDR module from Silicon Labs.

MSRP - \$79⁰⁰
MIKROE-4087



ISM TX Click

The MAX41460, a UHF sub-GHz ISM/SRD transmitter from Maxim Integrated.

MSRP - \$12⁰⁰
MIKROE-4242



RFID 2 Click

The ID-12LA-SA, an advanced low-cost RFID reader module with 38 different tags.

MSRP - \$79⁰⁰
MIKROE-4208



BT Click

The BT121, a dual-mode Bluetooth Smart Ready module from Silicon Labs.

MSRP - \$59⁰⁰
MIKROE-4384



NFC 2 Click

The PN7150, designed for contactless communication at 13.56 MHz from NXP.

MSRP - \$34⁰⁰
MIKROE-4309



ISM RX 2 Click

Features the Si4356, a standalone Sub-GHz RF receiver IC, from Silicon Labs.

MSRP - \$15⁰⁰
MIKROE-4230



GNSS RTK Click

The ZED-F9P, a multi-band GNSS module with integrated multi-band (RTK) technology from U-blox.

MSRP - \$229⁰⁰
MIKROE-4456



LTE IoT 9 Click

Features the EXS62-W, LTE-IoT Wireless Module from Thales.

MSRP - \$69⁰⁰
MIKROE-4465



ISM RX Click

Features the MAX1471, a low-power CMOS RF dual-channel receiver.

MSRP - \$69⁰⁰
MIKROE-4499



BLE TINY Click

Features the DA14531MOD, Smart-Bond TINY module.

MSRP - \$15⁰⁰
MIKROE-4582

SENSORS

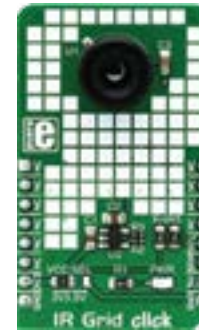

IR Grid Click

Equipped with the MLX90621BAD, a 16x4 IR array sensor, from Melexis.

MSRP – \$69⁰⁰
MIKROE-2622



Moisture Click

FDC2112 IC, a very precise 12bit capacitance to digital converter, from Texas Instruments.

MSRP – \$19⁰⁰
MIKROE-3084



Accel Click

With ADXL345 3-axis accelerometer. 13-bit measurement, embedded FIFO technologies.

MSRP – \$19⁰⁰
MIKROE-1194



Accel 2 Click

LIS3DSH IC 3-axis accelerometer. Embedded FIFO buffer and 2 programmable state machines.

MSRP – \$19⁰⁰
MIKROE-1905



Accel 3 Click

H3LIS331DL 3-axis linear accelerometer. Dynamically selectable scales ±100g/±200g/±400g.

MSRP – \$21⁰⁰
MIKROE-2102



6DOF IMU 2 Click

With BMI160 low power IMU. For precise acceleration and gyroscopic measurement.

MSRP – \$24⁰⁰
MIKROE-2337



9DOF Click

LSM9DS1 inertial measurement module - 3D accelerometer, gyroscope and magnetometer.

MSRP – \$24⁰⁰
MIKROE-1941



Hydrogen Click

With MQ-8 sensor for hydrogen [H₂]. Sensor's detection range 100-10000ppm of H₂.

MSRP – \$15⁰⁰
MIKROE-1629



Angle 3 Click

With AK7451, a magnetic rotational angle sensor with 12-bit angle resolution.

MSRP – \$18⁰⁰
MIKROE-2755



Barometer Click

LPS25HB IC, piezoresistive absolute pressure sensor. Range 260-1260 hPa.

MSRP – \$15⁰⁰
MIKROE-1817





Opto Encoder Click

Uses the TCUT1600X01, a tall dome dual channel transmissive optical sensor from Vishay.

MSRP – \$9⁰⁰
MIKROE-2549



Ozone Click

Carries MiCS-2614, a compact MOS sensor for ozone [O3] detection.

MSRP – \$69⁰⁰
MIKROE-2355



LightRanger 8 Click

The VL53L3CX, a ToF ranging sensor with multi-target detection.

MSRP – \$12⁰⁰
MIKROE-4492



Diff Press Click

The MPXV7007DP, integrated monolithic differential pressure sensor from NXP .

MSRP – \$27⁰⁰
MIKROE-3332



GeoMagnetic Click

Measures the geomagnetic field in three perpendicular axes. The onboard sensor uses FlipCore from Bosch.

MSRP – \$15⁰⁰
MIKROE-2935



Air quality Click

MQ-135 sensor for detecting gases - ammonia, nitrogen oxides, benzene, smoke, CO2.

MSRP – \$16⁵⁰
MIKROE-1630



Air quality 2 Click

iAQ-Core that measures VOC levels and provides CO2 equivalent and TVOC equivalent predictions.

MSRP – \$79⁰⁰
MIKROE-2529



Air quality 3 Click

Equipped with the CCS811, an ultra-low power digital gas sensor for monitoring the indoor air quality [IAQ].

MSRP – \$29⁰⁰
MIKROE-2953



Air quality 4 Click

An advanced air quality sensing device that combines multiple metal-oxide sensing elements on a chip.

MSRP – \$32⁰⁰
MIKROE-2896



Air quality 5 Click

MiCS-6814, a compact triple MOS sensor from SGX Sensortech, with 3 independent sensors.

MSRP – \$45⁰⁰
MIKROE-3056



RTD Click

It is based on MAX31865 resistance to digital converter optimized for RTDs.

MSRP – \$19⁰⁰
MIKROE-2815



10DOF Click

With BNO055, a 9-axis absolute orientation sensor and BMP180, a digital pressure sensor.

MSRP – \$49⁰⁰
MIKROE-2073



3D Hall Click

With MLX90333 3-axis Hall sensor. Detects the position of any magnet in nearby space.

MSRP – \$25⁰⁰
MIKROE-1987



3D Motion Click

MM7150 9-axis sensor fusion motion module and SSC7150 motion coprocessor.

MSRP – \$59⁰⁰
MIKROE-1877



6DOF IMU Click

STM's LSM6DS33TR 6-axis IMU with 3-axis gyroscope and 3-axis accelerometer.

MSRP – \$49⁰⁰
MIKROE-1298



Bi Hall Click

US2882 bipolar Hall-effect switch and a 74LVC1T45 single bit, dual supply transceiver.

MSRP – \$12⁰⁰
MIKROE-1646



CO Click

MQ-7 gas sensor with high sensitivity to carbon monoxide. Detection range 20ppm-2000ppm.

MSRP – \$16⁵⁰
MIKROE-1626



Color Click

With TCS3471 [RGBC] color light sensor and a RGB LED diode. Resolution up to 16-bits.

MSRP – \$15⁰⁰
MIKROE-1438



Color 2 Click

ISL29125 RGB color light sensor. 16-bit resolution data, measuring range 5.7 mlux-10,000 lux.

MSRP – \$16⁰⁰
MIKROE-1988



Color 3 Click

With TCS3771 color sensor and a narrow beam Infrared LED.

MSRP – \$17⁰⁰
MIKROE-2103





Compass Click
With LSM303DLHC ultra compact high performance e-compass module.

MSRP - \$25⁰⁰
MIKROE-1386



Compass 2 Click
With AK8963 3-axis elec. compass based on the Hall effect. 14-/16-bit selectable resolution.

MSRP - \$25⁰⁰
MIKROE-2264



Current Click
With INA196 current shunt monitor, MCP3201 12-bit ADC, MAX6106 voltage reference.

MSRP - \$24⁰⁰
MIKROE-1396



DHT22 Click
With DHT22 temp. and humidity measurement sensor. Hum. 0-100%, temp. -40 to +80° C.

MSRP - \$24⁰⁰
MIKROE-1798



Diff pressure Click
MPXV5010DP pressure sensor. Designed for comparing 2 pressure measurements.

MSRP - \$59⁰⁰
MIKROE-2387



Heart rate 3 Click
SFH7050 pulse oximetry and heart rate monitoring module, and AFE4404 IC for bio-sensing.

MSRP - \$39⁰⁰
MIKROE-2036



Heart rate 4 Click
Carrie the MAX30101 high-sensitivity pulse oximeter and heart-rate sensor.

MSRP - \$21⁰⁰
MIKROE-2510



Heart Rate 5 Click
Uses the top-of-the-class integrated BIOFY® SFH 7072 sensor from OSRAM.

MSRP - \$32⁰⁰
MIKROE-3012



Heart Rate 7 Click
The VEMD8080 photo-sensor. A high-speed PD element, with sensitivity in the visible light spectrum.

MSRP - \$23⁰⁰
MIKROE-2998



Illuminance Click
With TSL2561 light-to-digital converter. Two photodiodes: full-spectrum and infrared light.

MSRP - \$16⁰⁰
MIKROE-1688



EMG Click
Measures the electrical activity produced by the skeletal muscles.

MSRP - \$29⁰⁰
MIKROE-2621



Environment Click
Measures temperature, relative humidity, pressure and Volatile Organic compounds gases.

MSRP - \$34⁰⁰
MIKROE-2467



Fever Click
Measures body temperature with MAX30205 sensor. Accuracy 0.1°C [37°C to 39°C].

MSRP - \$11⁰⁰
MIKROE-2554

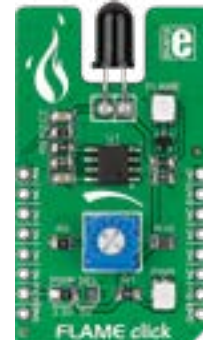

FLAME Click
Used for fire detection. Carries PT334-6B silicon phototransistor sensitive only to infrared light.

MSRP - \$12⁰⁰
MIKROE-1820



Force Click
With Interlink Electronics' Force Sensing Resistors. Force sensitivity range 0.2N-20N.

MSRP - \$25⁰⁰
MIKROE-2065



IR Sense Click
With AK9750 quantum-type IR sensor. Detects the temperature of objects and people in motion.

MSRP - \$27⁰⁰
MIKROE-2677



IrThermo Click 3.3V
With MLX90614ESF-BAA IR thermometer module, factory calibrated in wide temp. range.

MSRP - \$29⁰⁰
MIKROE-1361



Proximity 2 Click
With MAX44000, an IC that integrates an ambient light and a proximity sensor. Range 0.03-65.535 lux.

MSRP - \$19⁰⁰
MIKROE-1818



REED Click
With a standard reed switch. Used in mechanical systems as proximity sensors.

MSRP - \$7⁰⁰
MIKROE-1998



RF Meter Click
It's an RF power measurement device. Frequency span 1 MHz-8 GHz, over 60 dB range.

MSRP - \$44⁰⁰
MIKROE-2034





Earthquake Click

It carries D7S, the world's smallest high-precision seismic sensor from Omron.

MSRP - \$69⁰⁰
MIKROE-2561



ECG Click

It measures the electrical activity of a beating heart through electrodes taped to the skin.

MSRP - \$39⁰⁰
MIKROE-2455



ECG 2 Click

Tracks the patterns of your beating heart. It carries ADS1194 16-bit delta-sigma ADC.

MSRP - \$49⁰⁰
MIKROE-2507



HDC1000 Click

It's a humidity (and temperature) measurement Click carrying the HDC1000 sensor.

MSRP - \$19⁰⁰
MIKROE-1797



Heart rate Click

With Maxim's MAX30100 integrated pulse oximetry and heart-rate sensor.

MSRP - \$19⁰⁰
MIKROE-2000



LightHz Click

With TSL230BR converter for conversion of light intensity to frequency with no external components.

MSRP - \$17⁰⁰
MIKROE-990



LightRanger Click

It's a proximity sensor carrying VL6180X IC. Also works as an ambient light sensor.

MSRP - \$24⁰⁰
MIKROE-1897



LightRanger 2 Click

With VL53L0X IC, the world's smallest Time-of-Flight ranging and gesture detector sensor.

MSRP - \$24⁰⁰
MIKROE-2509



LIN HALL Click

Carries MLX90242 linear Hall sensor IC. Measures magnet's strength and distance.

MSRP - \$17⁰⁰
MIKROE-1648



Manometer 2 Click

With MS5525D-S0-SB001GS digital pressure sensor. 24-bit digital pressure and temp. value.

MSRP - \$39⁰⁰
MIKROE-2550



Grid-EYE Click

8x8 thermal array sensor-detector that carries AMG8853 infrared array sensor.

MSRP - \$79⁰⁰
MIKROE-2539



GYRO Click

L3GD20 3-axis digital gyroscope module - can measure angular rate and ambient temperature.

MSRP - \$25⁰⁰
MIKROE-1379



Hall current Click

High precision current sensor with TLI4970-D050T4, a magnetic current sensor.

MSRP - \$34⁰⁰
MIKROE-1578



IR eclipse Click

With EE-SX198 photo interrupter sensor - detects anything that obstructs its beam.

MSRP - \$15⁰⁰
MIKROE-1711



IR reflect Click

Carries GP2S700HCP reflective photo interrupter and an onboard potentiometer.

MSRP - \$12⁰⁰
MIKROE-1882



LSM6DSL Click

Measures linear and angular velocity with six degrees of freedom. Carries LSM6DSL module.

MSRP - \$15⁰⁰
MIKROE-2731



MAGNETO Click

Carries AS5048A contactless magnetic angle position sensor that relies on the Hall Effect.

MSRP - \$36⁰⁰
MIKROE-1886



MAGNETO 2 Click

Enables the design of non-contacting rotary position sensors with MLX90316 sensor IC.

MSRP - \$29⁰⁰
MIKROE-1938



Manometer Click

Carries a piezoresistive silicon pressure sensor with extremely high accuracy ($\pm 0.25\%$ FSS BFSL).

MSRP - \$79⁰⁰
MIKROE-2237



Barcode Click

The LV3296, a compact integrated barcode scanner from Rakinda company.

MSRP - \$179⁰⁰
MIKROE-2913



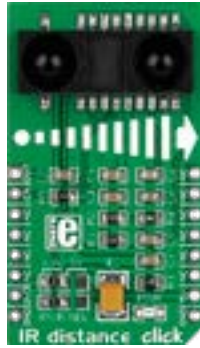

IR distance Click
With GP2Y0A60SZ0F distance measuring sensor. Measuring range 10-150 cm.

MSRP - \$25⁰⁰
MIKROE-1991



IrThermo Click 5V
With MLX90614ESF-AAA IR thermometer module, factory calibrated in wide temperature range.

MSRP - \$29⁰⁰
MIKROE-1362



IrThermo 2 Click
It is a non-contact temperature measurement solution, with an infrared thermopile sensor.

MSRP - \$20⁰⁰
MIKROE-1888



LDC1000 Click
With ind-to-digi. converter IC and a detachable inductive sensing.

MSRP - \$35⁰⁰
MIKROE-1583



Light Click
Used to measure ambient light intensity, with PD15-22CTR8 PIN photodiode.

MSRP - \$18⁰⁰
MIKROE-1424



Methane Click
With MQ-4 sensor for methane [CH4]. Detection range 200-10000ppm of CH4.

MSRP - \$15⁰⁰
MIKROE-1628



MOTION Click
It's a motion detector sensitive only to live bodies with PIR500B, a pyroelectric sensor.

MSRP - \$13⁰⁰
MIKROE-1589



MPU IMU Click
Carries MPU-6000 integrated 6-axis motion tracking device and a DMP [Digital Motion Processor].

MSRP - \$39⁰⁰
MIKROE-1577



Spectral Click
Uses the AS7261, an XYZ chromatic white color sensor + NIR with electronic shutter and smart interface.

MSRP - \$26⁰⁰
MIKROE-2972



Spectral 2 Click
Uses the AS7262, 6 channel visible spectral_ID device with electronic shutter and smart Interface.

MSRP - \$26⁰⁰
MIKROE-2973



Shake2Wake Click
With ADXL362 ultralow power, 3-axis MEMS accelerometer. Includes several activity detection modes.

MSRP - \$39⁰⁰
MIKROE-1942

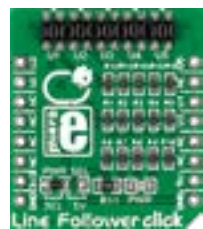

Line Follower Click
With five QRE1113 miniature reflective object sensors. Used for line following robots and cars.

MSRP - \$15⁰⁰
MIKROE-1999



LPG Click
With MQ-5 sensor for detecting liquefied petroleum gas leakage. Detection range 200-10000 ppm.

MSRP - \$15⁰⁰
MIKROE-1587

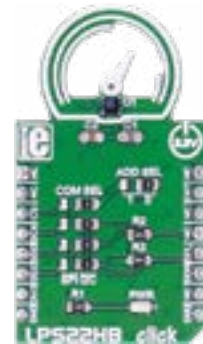

LPS22HB Click
Used as a digital barometer. It carries the LPS22HB MEMS nano pressure sensor.

MSRP - \$15⁰⁰
MIKROE-2665



LSM303AGR Click
Measures acceleration and magnetic field characteristics. Carries LSM303AGR module.

MSRP - \$18⁰⁰
MIKROE-2684



MPU 9DOF Click
Carries the MPU-9150 system in package, the world's first 9-axis motion tracking device.

MSRP - \$42⁰⁰
MIKROE-1719



Ozone 2 Click
With MQ131 sensor for Ozone [O3]. Detection range 10-1000 ppm of O3.

MSRP - \$37⁰⁰
MIKROE-2767



Pollution Click
Detects organic gases - formaldehyde, benzene, alcohol, toluene, etc. Detection range 1x50ppm.

MSRP - \$49⁰⁰
MIKROE-2516



Pressure Click
With LPS331AP digital output pressure sensor. For pressure [260-1260 mbar] and temp. [-40°C to 80°C].

MSRP - \$25⁰⁰
MIKROE-1422



Pressure 2 Click
With MS5803, a high resolution MEMS pressure sensor. Range 0-14 bars, resolution up to 0.2 mbars.

MSRP - \$69⁰⁰
MIKROE-1880





Spectral 3 Click

Uses the AS7263, a 6 channel NIR Spectral_ID device with electronic shutter and smart Interface.

MSRP - \$26⁰⁰
MIKROE-2961



IR Sense 2 Click

Uses the AK9752, an ultra-small infrared sensor IC, with an I2C interface, from AKM.

MSRP - \$21⁰⁰
MIKROE-2966



SHT Click

Temperature and humidity sensor SHT3x-DIS. -0 to 100% RH, 40 to 125°C temp. range.

MSRP - \$26⁰⁰
MIKROE-2101



SHT1x Click

Digital humidity and temperature sensor SHT11. Not recommended for newer designs.

MSRP - \$13⁰⁰
MIKROE-949



Smoke Click

With MAX30105 optical sensor for smoke detection. Sensor's inherent resolution 0.0625°C.

MSRP - \$19⁰⁰
MIKROE-2560



Stretch Click

Measures stretch forces with conductive rubber cord - 40-160 ohms per cm resistance.

MSRP - \$35⁰⁰
MIKROE-2064

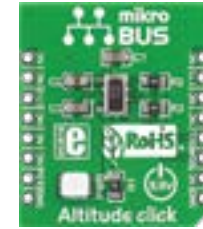

Altitude Click

MEMS pressure sensor MPL3115A2. Pressure/altitude [20-bit] and temp. [12-bit] data.

MSRP - \$14⁵⁰
MIKROE-1489



THERMO Click

With MAX31855K thermocouple-to-digital converter and PCC-SMP K-type thermocouple connector.

MSRP - \$29⁰⁰
MIKROE-1197



THERMO 2 Click

With DS1825, a digital thermometer IC with a unique 64-bit address. -10°C to 85°C, ±0.5°C accuracy.

MSRP - \$15⁰⁰
MIKROE-1840



Thermo 3 Click

With TMP102, a digital temp. sensor IC. Accurate within 0.5°C. Range from -25°C to 85°C.

MSRP - \$9⁰⁰
MIKROE-1885



Pressure 3 Click

With DPS310 digital barometric pressure sensor. Range 300-1200 hPa.

MSRP - \$20⁰⁰
MIKROE-2293



Proximity Click

With VCNL4010 proximity and ambient light sensor. Range up to 20cm, 16-bit resolution.

MSRP - \$17⁰⁰
MIKROE-1445



THERMO 4 Click

It carries digital temperature sensor and thermal watchdog. Range from -55 °C to +125 °C.

MSRP - \$9⁰⁰
MIKROE-2632



THERMO 5 Click

Measures temperature in default range of 0°C to 127°C and extended range of -64°C to 191°C.

MSRP - \$11⁰⁰
MIKROE-2571



Thermo 6 Click

Ambient temp. measurement device, based on the MAX31875 temp. sensor.

MSRP - \$9⁰⁰
MIKROE-2769



THERMO K Click

It carries the MCP9600 IC. It can measure temperatures from -200 °C to +1372 °C.

MSRP - \$24⁰⁰
MIKROE-2501



HTU21D Click

Carries a relative humidity sensor with temperature output. Rel. hum. 0-100%, temp. -40 to +125° C.

MSRP - \$21⁰⁰
MIKROE-1687



ProxFusion Click

A multifunctional capacitive and Hall-effect sensor device. Carries the IQS624, a combined multi-sensor IC.

MSRP - \$9⁰⁰
MIKROE-2920



Hall Switch Click

Uses the AH1389, an ultra-sensitive dual output unipolar Hall Effect switch, from Diodes Incorporated.

MSRP - \$18⁰⁰
MIKROE-2985



Thermo 7 Click

Uses the MCP9800, a high accuracy temperature sensor IC with the 2-Wire interface, from Microchip.

MSRP - \$9⁰⁰
MIKROE-2979





Thermostat Click
It carries MAX7502 IC that can measure temp. from -25°C to +100°C. Accuracy ±1.5°C.
MSRP - \$19⁰⁰
MIKROE-2273

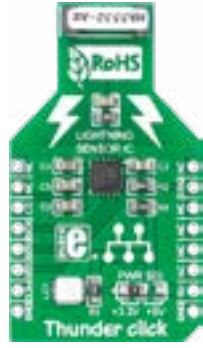

Thunder Click
Detects the presence and proximity of lightning activity with AS3935 lightning sensor.
MSRP - \$35⁰⁰
MIKROE-1444



Tilt Click
With RPI-1035, a 4-directional optical tilt sensor - left, right, backward, forward movement.
MSRP - \$12⁹⁰
MIKROE-1834



TILT-n-SHAKE Click
With MMA8491Q IC, a 3-axis digital accelerometer. Can function as a 45 ° tilt sensor.
MSRP - \$19⁰⁰
MIKROE-1853



UNI HALL Click
With US5881 unipolar Hall-effect switch sensitive to the North Pole magnetic fields.
MSRP - \$12⁰⁰
MIKROE-1647



UV Click
With ML8511 IC that is sensitive to UVA and UVB rays. Outputs either analog or digital signals.
MSRP - \$24⁰⁰
MIKROE-1677



UV 2 Click
Carries VEML6075 UVA and UVB light sensor. With a photodiode, amplifiers, analog/digital circuits.
MSRP - \$19⁰⁰
MIKROE-2378



UV 3 Click
An advanced ultraviolet [UV] light sensor with VEML6070 UVA light sensor.
MSRP - \$9⁰⁰
MIKROE-2736



Proximity 5 Click
Features the VCN-L4035X01 J, a fully integrated proximity and ambient light sensor.
MSRP - \$15⁰⁰
MIKROE-2984



Proximity 6 Click
Uses the ADUX1020, a photometric sensor for gesture and proximity detection.
MSRP - \$29⁰⁰
MIKROE-3048



Vibra sense Click
A micro shock vibration sensor with a digital output. For anti-tampering, anti-theft devices.
MSRP - \$18⁰⁰
MIKROE-1927



Water Detect Click
For detecting water and other electroconductive liquids. Carries Microchip's MCP606.
MSRP - \$9⁰⁰
MIKROE-2786



Weather Click
With BME280 integrated environmental unit. Detects humidity, pressure, and temperature.
MSRP - \$22⁰⁰
MIKROE-1978



Angle Click
Hall-effect angle sensing device used to measure the rotational angle of the magnetic field.
MSRP - \$16⁰⁰
MIKROE-2030



Thermo J Click
It is a temperature measurement Click board™, which uses a thermocouple type-J probe.
MSRP - \$24⁰⁰
MIKROE-2811



DHT22 2 Click
It is used for measuring the environmental temperature and relative humidity.
MSRP - \$22⁰⁰
MIKROE-2818



IrDA 3 Click
Intelligent IR transceiver device that sends and receives UART commands via the IR interface.
MSRP - \$26⁰⁰
MIKROE-2871



Microwave Click
It detects movement, thanks to the PD-V11 a 24GHz microwave motion sensor.
MSRP - \$25⁰⁰
MIKROE-2781



Proximity 3 Click
Intelligent proximity and light sensing device - high sensitivity long distance PS and ALS.
MSRP - \$17⁰⁰
MIKROE-2801



Alcohol Click
Detects alcohol in concentrations from 0.04 to 4mg/l with Q-3 Semiconductor sensor.
MSRP - \$15⁰⁰
MIKROE-1586





Hall current 2 Click
A Hall effect linear current sensor with over-current fault output for less than 100 V Isolation App.

MSRP - \$18⁰⁰
MIKROE-2987



UV 4 Click
Equipped with the Si1133, a UV index and ambient light sensor with I2C Interface, from Silicon Labs.

MSRP - \$15⁰⁰
MIKROE-2989



Temp&Hum Click
With HTS221 temp. and relative humidity sensor. Measurement accuracy is $\pm 1^\circ\text{C}$ in 0-60°C range.

MSRP - \$16⁰⁰
MIKROE-1971

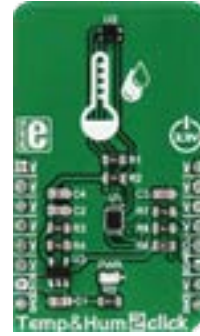

Temp&Hum 2 Click
Uses the Si7034, a digital humidity and temperature sensor IC with I2C interface, from Silicon Labs.

MSRP - \$16⁰⁰
MIKROE-3085



Temp-Hum 3 Click
Uses the HDC2010, a Low Power Humidity and Temperature Digital Sensor from Texas Instruments.

MSRP - \$13⁰⁰
MIKROE-2937



Vacuum Click
With the monolithic vacuum sensor the MPXV6115V, it measures pressure values down to -115kPa.

MSRP - \$43⁰⁰
MIKROE-3195



Ambient 4 Click
Uses the BH1721FVC, a 16-bit digital light sensor with the I2C serial interface.

MSRP - \$16⁰⁰
MIKROE-3199



3D HALL 5 Click
Carries the IIS2MDC-TR, a low power 3D magnetic sensor.

MSRP - \$15⁰⁰
MIKROE-3197



Color 8 Click
Features the ROHM's BH1749NUC, an integrated color sensor IC.

MSRP - \$15⁰⁰
MIKROE-3213



Accel 7 Click
Features the KXTJ3-1057 14-bit tri-axis digital accelerometer from Kionix.

MSRP - \$13⁰⁰
MIKROE-3244



Temp-Log Click
A precise ambient temp. measurement device, with 8Kbit (1024 bytes) of EEPROM memory.

MSRP - \$15⁰⁰
MIKROE-2886



Temp-Log 2 Click
A precise ambient temp. measurement device, with the non-volatile [EEPROM] memory.

MSRP - \$15⁰⁰
MIKROE-3004



Magneto 5 Click
Features the MEMSIC MMC34160PJ, a 3-axis magnetic sensor IC.

MSRP - \$15⁰⁰
MIKROE-3050



Color 6 Click
Features the AS73211, an XYZ true color sensor from AMS.

MSRP - \$32⁰⁰
MIKROE-3061



Color 7 Click
Features the TCS3472 color light to digital converter with IR filter, from AMS.

MSRP - \$16⁰⁰
MIKROE-3062



ECG 3 Click
Uses the MAX30003 IC, an ultra-low power, single channel, integrated biopotential AFE.

MSRP - \$45⁰⁰
MIKROE-3273



Gyro 2 Click
It is equipped with the FXAS21002C, a three-axis integrated angular rate gyroscope.

MSRP - \$18⁰⁰
MIKROE-3300



Heart rate 6 Click
With two green LEDs, driven by the BH1790GLC, a monolithic integrated sensor for heart rate monitoring.

MSRP - \$25⁰⁰
MIKROE-3215



IR Grid 3 Click
Equipped with the MLX90640-BAA, a 32x24 IR array sensor, from Melexis.

MSRP - \$87⁰⁰
MIKROE-3217



Ambient 2 Click
TI's OPT3001 ambient light sensor. Measures the visible part of the light spectrum.

MSRP - \$14⁰⁰
MIKROE-1903





Gaussmeter Click
The MLX90393, a micro-power magnetometer based on the proprietary Triaxis® technology.

MSRP - \$19⁰⁰
MIKROE-3099



Oximeter Click
The ADPD105, a highly configurable photometric front end (AFE) device from Analog Devices.

MSRP - \$39⁰⁰
MIKROE-3102



LightRanger 3 Click
Uses the Simblee™ enabled RFD77402 ToF sensor module from RF Digital.

MSRP - \$24⁰⁰
MIKROE-3103



IrThermo 3 Click
Uses the MLX90632 FIR sensor from Mel-exis as the contactless temperature sensor.

MSRP - \$27⁰⁰
MIKROE-3121



CO 2 Click
With the SPEC amperometric, 3SP CO 1000 gas sensor which electrochemically reacts with the [CO].

MSRP - \$52⁰⁰
MIKROE-3196



Alcohol 3 Click
Equipped with the MiCS-5524, a compact metal oxide [MOS] sensor.

MSRP - \$32⁰⁰
MIKROE-3318



Altitude 3 Click
Allows high-resolution barometric pressure measurement, with the ICP-10100 sensor.

MSRP - \$15⁰⁰
MIKROE-3328



Angle 2 Click
A magnetic rotational sensor which relies on the ultra-fast MA700 angular sensor IC.

MSRP - \$16⁰⁰
MIKROE-2338



Alcohol 2 Click
The LMP91000, a high-precision integrated analog front-end IC [AFE].

MSRP - \$52⁰⁰
MIKROE-3097



NO2 Click
The 3SP-NO2-20 gas sensor from SPEC Sensors, which can sense NO2 concentration up to 20ppm.

MSRP - \$52⁰⁰
MIKROE-3098



Accel 5 Click
Features an ultra-low power triaxial accelerometer sensor, labeled as the BMA400.

MSRP - \$19⁰⁰
MIKROE-3149



LightRanger 4 Click
Measures an accurate distance based on a ToF with VL53L1X rangefinder module.

MSRP - \$24⁰⁰
MIKROE-3176



Load cell Click
With the HX711, a 24bit analog to digital converter [ADC], for weight scale applications.

MSRP - \$12⁰⁰
MIKROE-3168

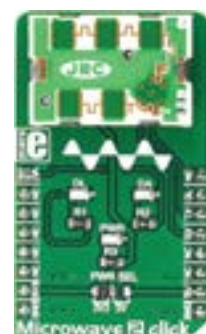

Microwave 2 Click
Detects movement by utilizing the NJR4265RF2C1, an intelligent 24GHz microwave motion sensor.

MSRP - \$55⁰⁰
MIKROE-3187



3D Hall 2 Click
Measures the magnetic field in three perpendicular axes. With the TLV493D-A1B6, a 3D magnetic sensor.

MSRP - \$15⁰⁰
MIKROE-3190

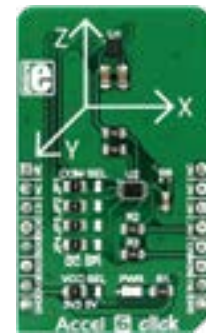

Accel 6 Click
The BMA280, a 14bit triaxial acceleration sensor with intelligent on-chip motion triggered interrupt controller.

MSRP - \$17⁰⁰
MIKROE-3075



Altitude 2 Click
Uses the MS5607-02BA03, a barometric pressure sensor IC with the stainless steel cap.

MSRP - \$15⁰⁰
MIKROE-3030



Pressure 4 Click
Features the BMP280, a digital pressure sensor, from Bosch Sensortech.

MSRP - \$18⁰⁰
MIKROE-3020



NDIR CO2 Click
Uses the CDM7160 integrated sensor and measures an absolute CO2 concentration.

MSRP - \$149⁰⁰
MIKROE-3134



Hall Current 3 Click
Uses Hall effect to provide a precise and reliable measurement of reasonably high current.

MSRP - \$19⁰⁰
MIKROE-3118





Temp&Hum 10 Click
The BPS230, a relative humidity sensor and temperature sensor with I²C Interface, by Bourns.

MSRP - \$16⁰⁰
MIKROE-3342



Temp&Hum 11 Click
The HDC1080, a low power humidity and temperature digital sensor from TI.

MSRP - \$13⁰⁰
MIKROE-3469



Temp&Hum 12 Click
The HDC2080, a Low Power Humidity and Temperature Digital Sensor from TI.

MSRP - \$21⁰⁰
MIKROE-3636



Temp&Hum 13 Click
The HTU21DF, a digital relative humidity sensor with temp. output from TE connectivity.

MSRP - \$12⁰⁰
MIKROE-3635



Pressure 6 Click
Allows readings in the range from 300hPa up to 1300hPa, with the BM1386GLV sensor.

MSRP - \$18⁰⁰
MIKROE-3216



Angle 4 Click
With the AEAT-8800-Q24, an integrated 10 to 16-bit programmable angular magnetic encoder.

MSRP - \$26⁰⁰
MIKROE-3130



Thermo 15 Click
The NCT75, a high accuracy temp. sensor IC with the 2-Wire interface, from ON Semiconductor.

MSRP - \$9⁰⁰
MIKROE-3658



Thermo 16 Click
The TMP235, a high accuracy temperature sensor IC Texas Instruments.

MSRP - \$9⁰⁰
MIKROE-3662



Temp&Hum 5 Click
The HIH6130, a relative humidity and temp. sensor with I²C Interface, by Honeywell.

MSRP - \$28⁰⁰
MIKROE-3425



Temp&Hum 9 Click
The SHTC3, a relative humidity and temp. sensor with I²C Interface, by Sensirion.

MSRP - \$13⁰⁰
MIKROE-3331



LDC 1101 Click
With the LDC1101, the integrated, high-res, high-speed, inductance-to-digital converter.

MSRP - \$29⁰⁰
MIKROE-3240



Magnetic linear Click
Which utilizes the HMC1501, a magnetic field displacement sensor IC.

MSRP - \$18⁰⁰
MIKROE-3274



Magnetic rotary Click
Which utilizes the HMC1512, a magnetic field displacement sensor IC.

MSRP - \$24⁰⁰
MIKROE-3275

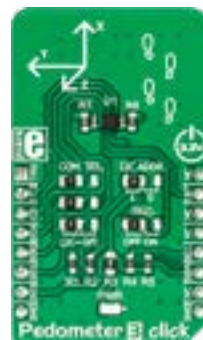

Pedometer 3 Click
Equipped with the KX126-1063, an advanced tri-axis acceleration sensor IC.

MSRP - \$13⁰⁰
MIKROE-3259



Hall Current 4 Click
Designed to measure relatively high current by using the integrated ACS70331 sensor.

MSRP - \$18⁰⁰
MIKROE-3308



IR Grid 2 Click
It is equipped with the MLX90640, a 32x24 IR array sensor which contains 8 Kbit EEPROM.

MSRP - \$75⁰⁰
MIKROE-3194



MAGNETO 4 Click
The AS5311, a high resolution magnetic linear encoder by ams.

MSRP - \$22⁰⁰
MIKROE-3522



MAGNETO 7 Click
The BM1422AGMV, a 3-axis magnetic sensor IC from ROHM Semiconductor.

MSRP - \$17⁰⁰
MIKROE-3657



3D Hall 3 Click
The LIS2MDL, a low power 3D magnetic sensor, from STMicroelectronics.

MSRP - \$15⁰⁰
MIKROE-3310



3D Hall 7 Click
The AK09970N, a low power 3D magnetic sensor, from AsahiKASEI [AKM].

MSRP - \$17⁰⁰
MIKROE-3629





Temp-Log 4 Click
Featuring the SE97B IC, an accurate temperature sensor IC with integrated EEPROM.

MSRP - \$12⁰⁰
MIKROE-3329



Ultrasonic 2 Click
Equipped with the PGA460, a highly-integrated system-on-chip (SoC), based on SONAR principle.

MSRP - \$29⁰⁰
MIKROE-3302



Proximity 9 Click
The VCNL4040, a fully integrated proximity and ambient light sensor from Vishay Semiconductors.

MSRP - \$9⁰⁰
MIKROE-3465



Smart DOF Click
The BN0080, a System in Package (SiP) sensor produced by Hillcrest Labs.

MSRP - \$26⁰⁰
MIKROE-3457



6DOF IMU 4 Click
The ICM-20602, a 6-axis MEMS Motion-Tracking™ IC from TDK Invensense.

MSRP - \$16⁰⁰
MIKROE-3410

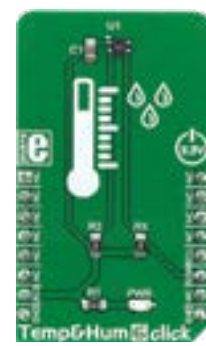

Temp&Hum 6 Click
With the ENS210 sensor. An ultra-accurate temperature and relative humidity sensor (RH).

MSRP - \$12⁰⁰
MIKROE-3270



Temp&Hum 7 Click
Equipped with the Si7021-A20, an accurate and reliable sensor IC.

MSRP - \$16⁰⁰
MIKROE-3272



Temp&Hum 8 Click
Based on a sensor from the popular SHT family, designed to measure temperature and humidity.

MSRP - \$19⁰⁰
MIKROE-3263



Tilt 2 Click
Equipped with the RB-441-45, a 45° rolling ball sensor switch.

MSRP - \$13⁰⁰
MIKROE-3343



Temp-Log 3 Click
Featuring the MCP9843 IC, an accurate temperature sensor IC with integrated EEPROM.

MSRP - \$12⁰⁰
MIKROE-3326



Thermo 11 Click
The TMP117, a high accuracy temp. sensor IC with the 2-Wire interface, from TI.

MSRP - \$12⁰⁰
MIKROE-3600



Color 5 Click
Features the P12347-01CT, a color and proximity sensor from Hamamatsu company.

MSRP - \$16⁰⁰
MIKROE-3107



Hall Current 6 Click
The ACS723(LLCTR-05AB-T), a high-accuracy, galvanically isolated current sensor IC, from Allegro Microsystems.

MSRP - \$18⁰⁰
MIKROE-3443



Temp-Log 5 Click
Equipped with the CAT34TS02 sensor from ON semiconductor.

MSRP - \$12⁰⁰
MIKROE-3442

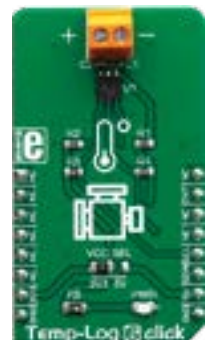

Temp-Log 6 Click
The MAX6642, a ±1°C, SMBus/I2C compatible local/remote temp. sensor by Maxim Integrated.

MSRP - \$9⁰⁰
MIKROE-3437



Pressure 7 Click
Features an digital barometric pressure and temperature sensor labeled as MS5837.

MSRP - \$49⁰⁰
MIKROE-3246



Remote Temp Click
The EMC1833 from Microchip, a specifically designed IC, measuring remote temperature.

MSRP - \$15⁰⁰
MIKROE-3685



Gyro 3 Click
With the I3G4250, a three-axis digital gyroscope.

MSRP - \$25⁰⁰
MIKROE-3449



Gyro 4 Click
A two-axis MEMS gyroscope for optical image stabilization app. with the L20G20IS.

MSRP - \$15⁰⁰
MIKROE-3661



Gyro 5 Click
Equipped with the ITG-3701, a three-axis digital gyroscope.

MSRP - \$20⁰⁰
MIKROE-3669





Ambient 3 Click
The AS7225, a calibrated XYZ chromatic smart lighting director from ams AG.

MSRP - \$25⁰⁰
MIKROE-3686

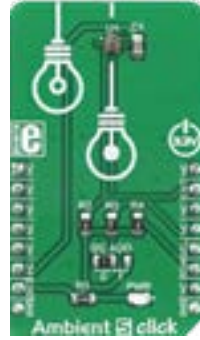

Ambient 5 Click
The VEML6030, a high accuracy ambient light sensor (ALS), from Vishay Semiconductors.

MSRP - \$11⁰⁰
MIKROE-3320



Ambient 6 Click
The AS5311, a high resolution magnetic linear encoder by ams.

MSRP - \$9⁰⁰
MIKROE-3444



Ambient 7 Click
The SFH 5701 A01, an accurate light-intensity sensor from Osram Opto Semiconductors.

MSRP - \$9⁰⁰
MIKROE-3601



Ambient 8 Click
The LTR-329ALS-01, a high accuracy ambient light sensor (ALS) from LiteOn.

MSRP - \$9⁰⁰
MIKROE-3452



6DOF IMU 8 Click
The ISM330DLC, a 3D accel. and 3D gyro. with digital output for industrial applications, by STMicroelectronics.

MSRP - \$21⁰⁰
MIKROE-3447



EEG Click
The INA114, a precision instrumentation amplifier (IA) by Burr Brown®, a division of TI.

MSRP - \$39⁰⁰
MIKROE-3359



ECG 4 Click
The BMD101, specialized bio-signal sensing System-on-Chip (SoC), from NeuroSky.

MSRP - \$35⁰⁰
MIKROE-3427



ECG 5 Click
The AD8232, an integrated heart rate monitoring front-end, by Analog Devices.

MSRP - \$35⁰⁰
MIKROE-3446



Hall current 5 Click
The ACS733(KLATR-AU), a Hall effect linear current sensor from Allegro Microsystems.

MSRP - \$18⁰⁰
MIKROE-3393



Pressure 5 Click
The BMP388, a digital pressure sensor, from Bosch Sensortech.

MSRP - \$14⁰⁰
MIKROE-3586



Pressure 8 Click
The MPRLS0025PA00001A, an accurate compensated pressure sensor, by Honeywell.

MSRP - \$21⁰⁰
MIKROE-3338



Pressure 9 Click
The DPS422, a digital barometric air pressure sensor, by Infineon.

MSRP - \$15⁰⁰
MIKROE-3441



Pressure 11 Click
The LPS33HW, digital output barometer IC in water-resistant package, from STMicroelectronics.

MSRP - \$24⁰⁰
MIKROE-3411



Pressure 12 Click
The ABP series gauge pressure sensor ABPLLNN600MGAA3, made by Honeywell.

MSRP - \$29⁰⁰
MIKROE-3466



Thermostat 2 Click
The G6D series PCB power relay, from Omron.

MSRP - \$15⁰⁰
MIKROE-3415



Opto Encoder 2 Click
The AK09970N, a low power 3D magnetic sensor, from AsahiKASEI [AKM].

MSRP - \$26⁰⁰
MIKROE-3634



Barometer 2 Click
The LPS35HW, an absolute digital output barometer IC in water-resistant package.

MSRP - \$15⁰⁰
MIKROE-3603



Pedometer Click
Contains the STP201M module, made by NiceRF.

MSRP - \$16⁰⁰
MIKROE-3567



IR Sense 3 Click
The AK9754, an ultra-small infrared sensor IC, with an I2C interface, from AKM.

MSRP - \$21⁰⁰
MIKROE-3607





3D Hall 6 Click
With the MLX90380, a monolithic contactless sensor IC module.

MSRP - \$15⁰⁰
MIKROE-3310



6DOF IMU 7 Click
The ICM-20649, a high-performance, 6-axis MEMS MotionTracking™ IC from TDK Invensense.

MSRP - \$16⁰⁰
MIKROE-3776



6DOF IMU 9 Click
The 6DOF IMU 9 click is based on the IAM-20680 is a 6-axis MotionTracking device for Automotive app.

MSRP - \$25⁰⁰
MIKROE-3827



6DOF IMU 11 Click
The KMX63 a tri-axis accelerometer, tri-axis magnetometer, and temp. sensor.

MSRP - \$21⁰⁰
MIKROE-3869



Accel 13 Click
The KMX63 a tri-axis accelerometer, tri-axis magnetometer, and temp. sensor.

MSRP - \$12⁰⁰
MIKROE-3742



Accel 8 Click
The MPU6050, a motion tracking sensor IC, from TDK Invensense.

MSRP - \$19⁰⁰
MIKROE-3341



Accel 11 Click
The BMA456, a digital triaxial acceleration sensor from Bosch Sensortech.

MSRP - \$17⁰⁰
MIKROE-3440



Accel 12 Click
The MC3216, a low-noise and low power 3-axis accelerometer, from mCube.

MSRP - \$9⁰⁰
MIKROE-3464



13DOF Click
The BME680 is a digital 4-in-1 sensor with gas, humidity, pressure and temp. measurement.

MSRP - \$35⁰⁰
MIKROE-3775



13DOF 2 Click
The BME680 is a digital 4-in-1 sensor with VOC, humidity, pressure and temp. measurement.

MSRP - \$42⁰⁰
MIKROE-3687



Color 9 Click
The APDS-9250, an integrated color sensor IC, made by Broadcom.

MSRP - \$12⁰⁰
MIKROE-3690



GMR Angle Click
The TLI5012B E1000 is a 360° angle sensor and the analog multiplexer 74HCT4053.

MSRP - \$17⁰⁰
MIKROE-3815



Heart Rate 9 Click
With PIC16F1779 8-bit MCU and SFH 7060 heart rate and pulse oximetry monitoring sensor.

MSRP - \$19⁰⁰
MIKROE-3822



N02 2 Click
With the MiCS-2714, a compact metal oxide [MOS] sensor.

MSRP - \$39⁰⁰
MIKROE-3700



Opto Encoder 3 Click
The TCUT1800X01 sensor is equipped with one infrared LED with the wavelength of 950nm.

MSRP - \$12⁰⁰
MIKROE-3710



Presence Click
The TPI1S 1385, a device from CaliPile™ multi-function IR sensor series by Excelitas Technologies.

MSRP - \$27⁰⁰
MIKROE-3575

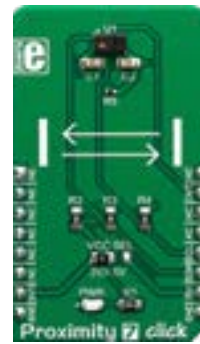

Proximity 7 Click
The ADPS9930, a digital ambient and proximity sensor, by Broadcom [Avago Technologies].

MSRP - \$14⁰⁰
MIKROE-3330



Proximity 8 Click
The VCNL36687S, a proximity sensor with VCSEL in a single package, from Vishay.

MSRP - \$13⁰⁰
MIKROE-3439



Hall Current 9 Click
The CQ3300, a high-speed response core-less current sensor using a Hall sensor.

MSRP - \$15⁰⁰
MIKROE-4466



AMR Current Click
The MCR1101-20-5 current sensor, which is an AMR based integrated current sensor.

MSRP - \$15⁰⁰
MIKROE-3812





Temp-Hum 4 Click

A smart environmental temp. and humidity sensor, uses HDC1010 sensor from Texas Instruments.

MSRP - \$13⁰⁰
MIKROE-2938



IR Click

Features TSOP38338 IR 38 kHz receiver module as well as QEE113 IR emitting diode.

MSRP - \$9⁰⁰
MIKROE-1377



IrDA2 Click

With TFDU4101 infrared transceiver module and MCP2120 infrared encoder/decoder.

MSRP - \$25⁰⁰
MIKROE-1195



IR Beacon Click

Functions as a beacon device with nine VSMB-2948SL high speed infrared emitting diodes.

MSRP - \$21⁰⁰
MIKROE-1939



GSR Click

Galvanic skin response [GSR] measures the electrodermal activity (EDA) of the human body.

MSRP - \$24⁰⁰
MIKROE-2860



Ambient 3 Click

The IIS2DLPC, a high-performance ultra-low-power 3-axis accel. for industrial app.

MSRP - \$12⁰⁰
MIKROE-3742



Proximity 10 Click

The SI1143, a photometric sensor for the ambient light and proximity detection.

MSRP - \$16⁰⁰
MIKROE-3455



Proximity 11 Click

The RPR-0521RS, a digital ambient and proximity sensor, by ROHM Semiconductor.

MSRP - \$9⁰⁰
MIKROE-3689



Remote Temp Click

The EMC1833, a ±1°C, SMBus/I2C compatible local/remote temperature sensor.

MSRP - \$15⁰⁰
MIKROE-3685



Thermo 13 Click

The BH1900NUX, a high accuracy temperature sensor IC with the 2-Wire interface.

MSRP - \$7⁰⁰
MIKROE-3688



Heart Rate 8 Click

It is an optical biosensor Click board™, designed for heart-rate monitoring (HRM).

MSRP - \$29⁰⁰
MIKROE-3218



Thermo 8 Click

It features the MCP9808, a digital temp. sensor with ±0.5 °C max. accuracy, from Microchip.

MSRP - \$9⁰⁰
MIKROE-3290



6DOF IMU 10 Click

Features the KMX62-1031 a 6 Degrees-of-Freedom inertial sensor from Kionix.

MSRP - \$21⁰⁰
MIKROE-3934



Thermo 9 Click

Features the TSY501, a digital temperature sensor from TE Connectivity.

MSRP - \$12⁰⁰
MIKROE-3983



Proximity 13 Click

Based on SI1153-AB09-GMR IC from Silicon Labs that can be used as a proximity, and gesture detector.

MSRP - \$13⁰⁰
MIKROE-3991



PIR Click

The PL-N823-01 -a PL Pyroelectric Infrared Sensors from KEMET.

MSRP - \$18⁰⁰
MIKROE-3339



Thermostat 3 Click

The MAX31855, it's IC a thermocouple-to-digital converter with a built-in 14-bit ADC.

MSRP - \$19⁰⁰
MIKROE-3724



TMR Angle Click

The TLE5501 it's an angle sensors for any kind of angular position sensing.

MSRP - \$17⁰⁰
MIKROE-3769



CAMERA Click

Carries OV7670-VL2A, a low voltage CMOS image sensor.

MSRP - \$39⁰⁰
MIKROE-1816



Ambient Click

With MLX75305 IC, CMOS integrated optical sensor. Converts ambient light intensity into voltage.

MSRP - \$9⁰⁰
MIKROE-1890





Load Cell 2 Click

Features NAU7802 24-Bit Dual-Channel ADC For Bridge Sensors.

MSRP - \$9⁰⁰
MIKROE-4047

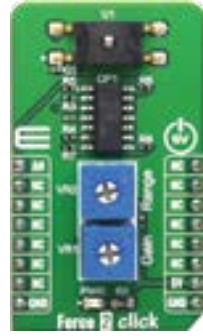

Force 2 Click

With the FSS015NGT Honeywell's FSS-SMT Series force sensor.

MSRP - \$149⁰⁰
MIKROE-4046



6DOF IMU 12 Click

The BMI270 IC, a low power inertial measurement unit, from Bosch Sensortec.

MSRP - \$15⁰⁰
MIKROE-4073



Motion 2 Click

Based on EKMC1607112, PIR motion sensor from Panasonic Corporation.

MSRP - \$29⁰⁰
MIKROE-4059



Motion 3 Click

Based on EKMC1606112, PIR motion sensor from Panasonic Corporation.

MSRP - \$24⁰⁰
MIKROE-4049



Ambient 11 Click

With the VEML6035, a low power, high sensitivity, I2C ambient light sensor from Vishay Semiconductors.

MSRP - \$9⁰⁰
MIKROE-3990



Heater Click

Set and control exact PCB temp. with the TMP235 on board temp. sensor from Texas Instruments.

MSRP - \$9⁰⁰
MIKROE-3996



Thermo 17 Click

The TMP451-Q1, a high-accuracy, low-power remote temp. sensor monitor with a built-in local temp. sensor.

MSRP - \$9⁰⁰
MIKROE-3994



SHT AN Click

The SHT31-ARP, a high accuracy temperature and humidity sensor from Sensirion.

MSRP - \$16⁰⁰
MIKROE-3984



Color 10 Click

It's based on VEML3328, a RGB and IR light sensor from Vishay.

MSRP - \$7⁰⁰
MIKROE-3997



Compass 3 Click

The MMC5883MA, a complete 3-axis magnetic sensor with signal processing from MEMSIC.

MSRP - \$9⁰⁰
MIKROE-4063



ECG 6 Click

It features the MAX86150, a Reflective Heart Rate Monitor and Medical-Grade Pulse Oximeter.

MSRP - \$29⁰⁰
MIKROE-4061



6DOF IMU 3 Click

The FXOS8700CQ is a low-power 3-axis linear accelerometer, and 3-axis magnetometer.

MSRP - \$7⁰⁰
MIKROE-4086



Motion 4 Click

Features EKMC1603111, a PIR motion sensor from Panasonic Corporation.

MSRP - \$29⁰⁰
MIKROE-4078



6DOF IMU 5 Click

Features 7-Axis ICM-20789 chip from TDK.

MSRP - \$19⁰⁰
MIKROE-4089



Index Counter Click

Features the TLE4966K, an integrated circuit double Hall-effect sensor.

MSRP - \$7⁰⁰
MIKROE-4005



Radiation Click

Feature the BG51 radiation sensor is based on an array of customized PIN diodes.

MSRP - \$129⁰⁰
MIKROE-4036



VCP Monitor Click

The NA260AIPWR, a digital-output, current, power, and voltage monitor with an I2C and SMBus™ interface.

MSRP - \$16⁰⁰
MIKROE-4039



Heart Rate 2 Click

The MAXM8616 - Single-Supply Integrated Optical Module for HR and SpO2 Measurement.

MSRP - \$23⁰⁰
MIKROE-4037



6DOF IMU 6 Click

The ICM-20689, a 6-axis Motion-tracking with a 3-axis gyroscope, a 3-axis accelerometer, and a DMP.

MSRP - \$15⁰⁰
MIKROE-4044





9DOF 3 Click

The BMX055, a 9-axis sensor for the detection of movements, rotations, and magnetic heading.

MSRP – \$16⁰⁰
MIKROE-4153



Light mix-sens Click

The TMD37253 IC, a proximity measurement, color sense (RGB+C+IR), and digital ALS device, from AMS.

MSRP – \$7⁰⁰
MIKROE-4148



Force 4 click

Based on HSFPA-R003A piezoresistive force sensor from Alpsalpine.

MSRP – \$29⁰⁰
MIKROE-4193

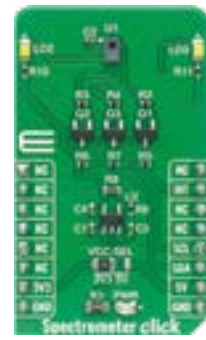

Spectrometer Click

Uses the AS7341 IC, 11-Channel Spectral Sensor Frontend from AMS-AG.

MSRP – \$24⁰⁰
MIKROE-4165



Surface temp Click

With the ADT7420 - an accurate 16-Bit Digital I2C temp. sensor from Analog Devices.

MSRP – \$19⁰⁰
MIKROE-4205



TMR mix-sens Click

With three different Coto Technology RedRock™ TMR magnetic sensors.

MSRP – \$19⁰⁰
MIKROE-4106



Accel 10 Click

The LIS2DW12TR, a high-performance ultra-low-power 3-axis “femto” accelerometer.

MSRP – \$9⁰⁰
MIKROE-4112



Scanner Click

The TSL3301CL IC, 102 x 1 linear optical sensor array with onboard A/D conversion from AMS-AG.

MSRP – \$24⁰⁰
MIKROE-4108



9DOF 2 Click

Based on the ICM-20948, a high performance, 9-axis MotionTracking™ IC from TDK Invensense.

MSRP – \$15⁰⁰
MIKROE-4128



Altitude 4 Click

Uses the NPA-201 IC, an absolute pressure sensor with digital output for low-cost applications.

MSRP – \$12⁰⁰
MIKROE-4127



Ammonia Click

An Ammonia detection [NH3] sensor, based on the MQ-137 gas sensor.

MSRP – \$55⁰⁰
MIKROE-4151



Hydro Probe Click

Uses the MIC1557 and MCP3221 IC's. The capacitive soil moisture sensors.

MSRP – \$9⁰⁰
MIKROE-4131



Accel 14 Click

Uses the IIS3DWB IC, an ultra-wide bandwidth, low-noise, 3-axis digital vibration sensor.

MSRP – \$32⁰⁰
MIKROE-4185



Thermostat 4 Click

The TMP392, enables protection and detection of system thermal events from 30°C to 130°C.

MSRP – \$15⁰⁰
MIKROE-4194



Barometer 3 Click

Based on DPS368, a digital barometric air pressure sensor IC from Infineon.

MSRP – \$8⁰⁰
MIKROE-4190



Thermo 14 Click

The STTS22H, a high accuracy temp. sensor IC with the 2-Wire interface, from STMicroelectronics.

MSRP – \$7⁰⁰
MIKROE-4132



UVB Click

Based on GU-VB-C31SM, a Digital UV Sensor from GENUV Technology.

MSRP – \$24⁰⁰
MIKROE-4145



UVC Click

The GUVV-T21GH UV sensor from GenUV, measures UVC spectrum in the range of 220nm up to 280nm.

MSRP – \$45⁰⁰
MIKROE-4144



Magneto 6 Click

Uses the TL1493D-A2B6 IC, low power 3 dimensional I2C Hall effect sensor with I2C interface, from Infineon.

MSRP – \$12⁰⁰
MIKROE-4139



Pressure 10 Click

Uses the HSPPAD042A IC, a digital pressure sensor, from ALPS ELECTRIC.

MSRP – \$12⁰⁰
MIKROE-4142





Angle 5 Click
The MA302, a 12-bit digital contactless angle sensor with ABZ and UVW incremental outputs.

MSRP - \$18⁰⁰
MIKROE-4270



Compass 4 Click
Features AK09915, a complete 3-axis magnetic sensor with signal processing from AKM.

MSRP - \$12⁰⁰
MIKROE-4231



6DOF IMU 15 click
Features the ASM-330LHH, automotive 6-axis MEMS motion tracking device.

MSRP - \$24⁰⁰
MIKROE-4330



Thermo 19 Click
The MAX31825, a digital thermometer with 12-bit temp. measurements.

MSRP - \$9⁰⁰
MIKROE-4295



XSENS MTi-3 Click
The MTi-3, a module outputting 3D orientation, 3D rate of turn, 3D accelerations, and 3D magnetic field.

MSRP - \$399⁰⁰
MIKROE-4192



Force 3 Click
Based on the FSR 400 series 34-00004 single zone Force Sensing Resistor IC from Interlink Electronics.

MSRP - \$25⁰⁰
MIKROE-4149



Magneto 8 Click
Features the AS5601, 12-bit programmable contactless encoder IC from AMS-AG.

MSRP - \$15⁰⁰
MIKROE-4204



6DOF IMU 14 Click
The ICM-42688-P, high precision 6-axis MEMS motion tracking device, from TDK InvenSense.

MSRP - \$15⁰⁰
MIKROE-4237



Ambient 9 Click
The APDS-9160-003, digital proximity, and ambient light sensing sensor from Broadcom Limited.

MSRP - \$9⁰⁰
MIKROE-4197



Oximeter 3 Click
Features the VCN-L4020C-GS08, a fully integrated high-resolution digital biosensor.

MSRP - \$15⁰⁰
MIKROE-4267



Pressure 13 Click
The KP229E2701, a miniaturized analog absolute pressure sensor.

MSRP - \$12⁰⁰
MIKROE-4294



Force 5 Click
The FMAMSDXX025W-C2C3, a piezoresistive-based force sensor with a digital output.

MSRP - \$55⁰⁰
MIKROE-4305



Temp&Hum 14 Click
The SHT40, high-accuracy ultra-low-power 16-bit relative humidity and temperature sensor.

MSRP - \$15⁰⁰
MIKROE-4306



Thermo 20 Click
The TSY503, a digital temp. sensor with precise digital output and low power consumption.

MSRP - \$7⁰⁰
MIKROE-4316



PHT Click
The MS8607, a digital combination sensor providing 3 environmental measurements.

MSRP - \$7⁰⁰
MIKROE-4348



6DOF IMU 13 Click
The MC6470 with an accelerometer and magnetometer for a 6 DoF sensor solution.

MSRP - \$9⁰⁰
MIKROE-4228



Air quality 7 Click
The MiCS-VZ-89TE, an integrated sensor module for indoor air quality monitoring from Amphenol.

MSRP - \$32⁰⁰
MIKROE-4196



Surface temp 2 Click
Features the ADT7422, a 16-bit I2C temperature sensor from Analog Devices.

MSRP - \$16⁰⁰
MIKROE-4266



RTD 2 Click
The ADS1247, a highly integrated 24-bit data converters with a PGA.

MSRP - \$24⁰⁰
MIKROE-4282



Barcode 2 Click
The EM3080-W, a barcode decoder chip with superior performance, and low power consumption.

MSRP - \$139⁰⁰
MIKROE-4195



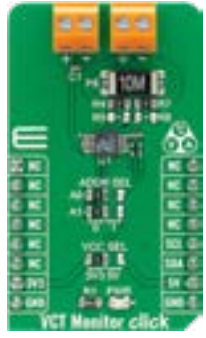

VCT Monitor Click
The LTC2990, a high-performance temperature, voltage, and current monitor.

MSRP - \$15⁰⁰
MIKROE-4353



Vibra Sense 2 Click
The LDTM-028K a vibration sensor, offering high sensitivity at low frequencies.

MSRP - \$26⁰⁰
MIKROE-4355



Compass 5 Click
The AK09918C, a 3-axis electronic compass with high sensitive Hall sensor technology.

MSRP - \$15⁰⁰
MIKROE-4366



RAQ Click
The ZMOD4450, a gas sensor module used to detect typical gases inside refrigeration applications.

MSRP - \$35⁰⁰
MIKROE-4385



pH Click
The pH EZO™, offers the highest level of stability and accuracy from AtlasScientific.

MSRP - \$89⁰⁰
MIKROE-4297



Smoke 2 Click
The ADPD188BI module for smoke detection with optical dual-wave-length technology.

MSRP - \$45⁰⁰
MIKROE-4299



Environment 2 Click
The SHT40 and SGP40, a high-accuracy best-in-class SHT relative humidity, and a temp. sensor.

MSRP - \$19⁰⁰
MIKROE-4558



Temp&Hum 15 Click
The SHT40, high-accuracy ultra-low-power 16-bit relative humidity and temperature sensor.

MSRP - \$7⁰⁰
MIKROE-4496



Accel 15 Click
The BMA490L, a high-performance 16-bit digital triaxial longevity acceleration sensor.

MSRP - \$9⁰⁰
MIKROE-4501



ECG/GSR Click
The AS7030B, a vital sign sensor with PPG and Electrocardiogram [ECG] operations.

MSRP - \$27⁰⁰
MIKROE-4500



Hall Current 7 Click
The ACS770, a Hall effect-based high precision linear current sensor with 100μA current conductor.

MSRP - \$29⁰⁰
MIKROE-4420



Temp Probe Click
The LTC2986, a high accuracy digital temperature measurement system.

MSRP - \$89⁰⁰
MIKROE-4301



Load Cell 4 Click
Features the ZSC31014, a CMOS integrated circuit for highly accurate amplification.

MSRP - \$12⁰⁰
MIKROE-4458



Oximeter 2 Click
The ADPD144RI, a PPG optical sensor for photoplethysmography detection of blood oxygenation.

MSRP - \$18⁰⁰
MIKROE-4292



Pressure 14 Click
The ABP2LANT060P-G2A3XX, a piezoresistive silicon pressure sensor.

MSRP - \$29⁰⁰
MIKROE-4424



Load Cell 5 Click
The AD7780- pin-programmable, low power, 24-bit sigma-delta ADC from Analog Devices.

MSRP - \$21⁰⁰
MIKROE-4510



AMR Angle Click
Features the ADA4571, an AMR sensor with clean and amplified cosine and sine output signals.

MSRP - \$24⁰⁰
MIKROE-4561



INTERFACE



RS232 2 Click

The MAX3237E, a 3V to 5.5V multichannel RS232, 1 Mbit/s line driver/receiver from Texas Instruments.

MSRP - \$15⁰⁰
MIKROE-2897



1-Wire I2C Click

Converts I2C to 1-wire with DS28E17 1-Wire-to-I2C master bridge from Maxim Integrated.

MSRP - \$22⁰⁰
MIKROE-2750



4-20 mA R Click

Serves as a receiver in a 4-20mA current loop standard. Converts it into a voltage [0.4-2V].

MSRP - \$26⁰⁰
MIKROE-1387



4-20 mA T Click

Easy solution for adding 4-to-20mA industry standard communication protocol to your design.

MSRP - \$26⁰⁰
MIKROE-1296

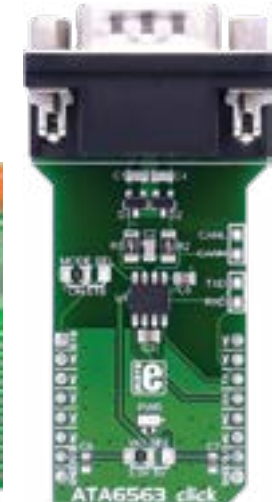

ATA6563 Click

Microchip's ATA6563 high-speed CAN transceiver for Classical CAN and CAN FD networks.

MSRP - \$20⁰⁰
MIKROE-2334



ATA663211 Click

LIN transceiver IC designed to handle low-speed data communication in applications.

MSRP - \$19⁰⁰
MIKROE-2335



CAN Isolator Click

Provides isolated CAN communication. Data rates of up to 1 Mbps. Carries a DB 9-pin male connector.

MSRP - \$39⁰⁰
MIKROE-2627



CAN SPI Click 3.3V

Adds CAN connectivity with SPI interface. Features SN65HVD230 CAN transceiver circuit.

MSRP - \$21⁰⁰
MIKROE-986



CAN SPI Click 5V

Adds CAN connectivity with SPI interface. With MCP2551 CAN transceiver circuit.

MSRP - \$21⁰⁰
MIKROE-988



DALI Click

Provides Digital Lighting Interface. With two optocouplers, push button, screw terminal.

MSRP - \$25⁰⁰
MIKROE-1297





ETH Click

With ENC28J60, a 28-pin, 10BASE-T stand-alone Ethernet controller with an on-board MAC & PHY.

MSRP - \$24⁰⁰
MIKROE-971



ETH WIZ Click

With W5500, a 48-pin, 10/100 BASE-TX stand-alone Ethernet controller. Standard RJ-45 connector.

MSRP - \$19⁰⁰
MIKROE-1718



EXPAND Click

Expands the number of input-output lines with Microchip's 16-bit I/O expander MCP23S17.

MSRP - \$12⁰⁰
MIKROE-951



Expand 2 Click

Expands the number of input-output lines with Microchip's 16-bit I/O expander MCP23017.

MSRP - \$12⁰⁰
MIKROE-1838



Expand 3 Click

With DS2408, an 8-channel programmable I/O expander from Maxim Integrated.

MSRP - \$19⁰⁰
MIKROE-1874



USB SPI Click

Microchip's MCP2210 USB-to-SPI protocol converter with GPIO as well as USB MINI B connector.

MSRP - \$13⁰⁰
MIKROE-1204



USB UART 2 Click

Provides USB isolation and carries the AD-UM4160BRWZ USB port isolator.

MSRP - \$39⁰⁰
MIKROE-2674



USB UART Click

Adds serial UART communication via USB cable. With FT232RL USB-to-UART interface module.

MSRP - \$13⁰⁰
MIKROE-1203



ATA663254 Click

It is a fully integrated LIN transceiver device with an integrated 5V LDO voltage regulator.

MSRP - \$16⁰⁰
MIKROE-2872



OBDII Click

Tap inside the car diagnostic systems! Features the STN1110 Multiprotocol OBD to UART Interface.

MSRP - \$9⁰⁰
MIKROE-2452



EXPAND 4 Click

Port expander for high power peripherals with TPC1C6A595 power logic 8-bit register.

MSRP - \$14⁰⁰
MIKROE-1910



BroadR-Reach Click

For realizing network in harsh environments that require reliable Ethernet-based open network.

MSRP - \$69⁰⁰
MIKROE-2796



USB UART 4 Click

USB to asynchronous serial data transfer interface. With FT232RL, USB-to-UART interface module.

MSRP - \$13⁰⁰
MIKROE-2810



RS232 Click

Adds RS232 connectivity with a standard RS232 DB9 port and a MAX3232 IC.

MSRP - \$15⁰⁰
MIKROE-1582



USB I2C Click

With MCP2221 USB-to-UART/I2C converter. Full-speed USB (12 Mb/s), I2C up to 400 kHz clock rates.

MSRP - \$13⁰⁰
MIKROE-1985



4D - display Click

Offers a mikroBUS™ interface for controlling 4D Systems gen4 Series Intelligent Display Modules.

MSRP - \$9⁰⁰
MIKROE-3044



Fiber Opt Click

Adds fiber-optic communication with IF-D91 fiber-optic photodiode, IF-E97 fiber-optic LED diode.

MSRP - \$34⁰⁰
MIKROE-1940



FTDI Click

With FT232H - dual high speed USB 2.0 to UART/I2C/SPI serial interface converter.

MSRP - \$29⁰⁰
MIKROE-1421



I2C 1-Wire Click

Performs bidirectional conversions between I2C masters and 1-Wire slave devices with DS2482-800.

MSRP - \$28⁰⁰
MIKROE-1892



I2C Isolator Click

TI's IS01540, a low-power, bidirectional isolator compatible with I2C interfaces.

MSRP - \$18⁰⁰
MIKROE-1878





SPI Isolator Click
Carries ADuM4154 5kV digital isolator optimized for a serial peripheral interface (SPI).
MSRP - \$29⁰⁰
MIKROE-2583



I2C Isolator 2 Click
Provides I2C lines and power isolation for slave devices with ADM3260 dual I2C isolator.
MSRP - \$24⁰⁰
MIKROE-2609

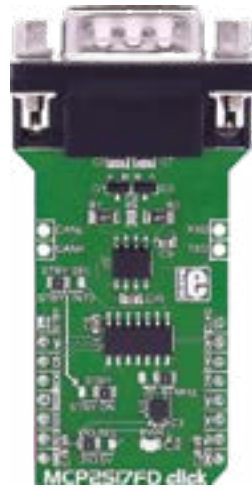

MCP2517FD Click
With MCP2517FD CAN FD controller and ATA6563 high-speed CAN transceiver.
MSRP - \$25⁰⁰
MIKROE-2379



RS485 2 Click
Carries MAX3471 half-duplex transceiver for lithium battery-powered RS-485/RS-422 applications.
MSRP - \$18⁰⁰
MIKROE-2700



RS485 3 Click
The Click is intended to be used as UART to RS422/RS485 communication interface.
MSRP - \$20⁰⁰
MIKROE-2821



MCP2542 Click
Microchip's CAN FD Transceiver with Wake-Up Pattern. Compliant with CAN 2.0 and CAN FD.
MSRP - \$20⁰⁰
MIKROE-2299



RS485 Isolator Click
With ADM2682EBRIZ, a 5 kV RMS signal and power isolated RS-485 transceiver.
MSRP - \$49⁰⁰
MIKROE-2673



MCP25625 Click
With CAN controller with an integrated transceiver. High speed operation up to 1 Mb/s.
MSRP - \$24⁰⁰
MIKROE-2228



MCP2003B Click
It's a physical interface to automotive and industrial LIN systems with a bi-directional LIN transceiver.
MSRP - \$18⁰⁰
MIKROE-2227



LLC-I2C Click
Used as the level converter for logic signals. It is perfectly suited for the bi-directional I2C communication.
MSRP - \$9⁰⁰
MIKROE-3276



RS485 Click 3.3V
Carries SN-65HVD12 half-duplex, RS-485 transceiver from Texas Instruments.
MSRP - \$18⁰⁰
MIKROE-989



RS485 Click 5V
Carries the ADM485 differential line transceiver from Analog Devices.
MSRP - \$18⁰⁰
MIKROE-925



PS/2 Click
Adds keyboard and mouse connectivity. With a standard 6-pin Mini-DIN PS/2 connector.
MSRP - \$9⁰⁰
MIKROE-1576



PWM Click
For controlling 16 PWM outputs through a single I2C interface. With PCA9685PW IC.
MSRP - \$14⁰⁰
MIKROE-1898



PWM 2 Click
With the LT8500, a 48-Channel LED PWM generator with 12-Bit res. and 50MHz serial interface.
MSRP - \$19⁰⁰
MIKROE-3148



LLC-SPI Click
Used as the level converter for logic signals. It is perfectly suited for SPI communication.
MSRP - \$9⁰⁰
MIKROE-3298



UART 1-Wire Click
Designed to convert standard UART or RS232 signals into 1-Wire® signals.
MSRP - \$22⁰⁰
MIKROE-3340



RS232 Isolator Click
Isolated dual transceiver Click - secure and easy UART to RS232 conversion, with galvanic isolation.
MSRP - \$56⁰⁰
MIKROE-2864



Skywire™ Click
Adapter Click, which hosts NimbleLink/Skywire™ cellular modems [using stacking headers].
MSRP - \$19⁰⁰
MIKROE-2405



Adapter Click
Simplifies connection of the add-on boards with IDC10 headers to mikroBUS™ socket.
MSRP - \$6⁵⁰
MIKROE-1432





Riverdi Click
An adapter for connecting Riverdi TFT displays to a mikroBUS™ socket.

MSRP - \$9⁰⁰
MIKROE-2100



RiBUS Click
An adapter for connecting any Riverdi TFT displays to a mikroBUS™ socket over the RiBUS connector.

MSRP - \$9⁰⁰
MIKROE-3642

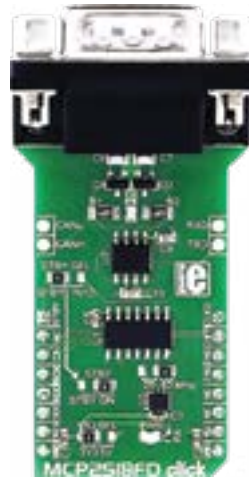

MCP2518D Click
The ATA6563, a high-speed CAN transceiver and the MCP2518FD, CAN FD controller both ICs by Microchip.

MSRP - \$25⁰⁰
MIKROE-3060



RS485 4 Click
The ADM2795E, a dual channel RS485 driver/receiver, with the ICoupler™ isolation technology, by Analog Devices.

MSRP - \$39⁰⁰
MIKROE-3395



UART I2C/SPI Click
The SC16IS740, 64 bytes of transmit and receive FIFOs, and IrDA SIR built-in support, from NXP.

MSRP - \$24⁰⁰
MIKROE-3349



Dual LIN Click
It's a dual transceiver for LIN with the TLE7268SKXUMA1 from Infineon.

MSRP - \$12⁰⁰
MIKROE-3870



eINK Click -WD
Click board adapter for connection of the e-paper displays to the MCU over SPI interface.

MSRP - \$7⁰⁰
MIKROE-3683



I2C to SPI Click
It's based around two SC18IS602B, an I2C-bus to SPI bridge from NXP.

MSRP - \$12⁰⁰
MIKROE-3743



LIN Click
It's the TLE7259-3GE, LIN transceiver with integrated wake-up and protection features.

MSRP - \$12⁰⁰
MIKROE-3816



M-Bus Master Click
It's the TLE7259-3GE, LIN transceiver with integrated wake-up and protection features.

MSRP - \$15⁰⁰
MIKROE-3880

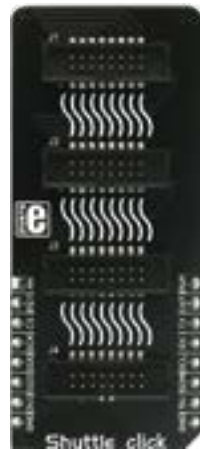

Shuttle Click
The mikroBUS™ socket expansion board, which allows stacking up to four Click boards™.

MSRP - \$8⁰⁰
MIKROE-2880



iButton™ Click
Comes with Maxim's DS1990A, a serial number iButton™ device with a unique 64-bit serial number.

MSRP - \$35⁰⁰
MIKROE-3045



USB UART 3 Click
The CP2102N, a highly integrated USB to UART interface, from Silicon Labs.

MSRP - \$15⁰⁰
MIKROE-3063



DALI 2 Click
It is used for interfacing with the DALI network, and as a compliant with the DALI-2 physical layer requirements.

MSRP - \$25⁰⁰
MIKROE-2672



ATA6570 Click
Uses the ATA6570, a standalone high speed CAN transceiver IC from Microchip.

MSRP - \$23⁰⁰
MIKROE-2900

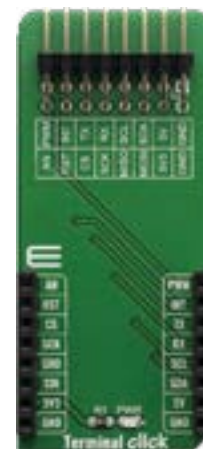

Terminal Click
The stackable mikroBUS™ extension board that can be used for testing or com. surveillance.

MSRP - \$7⁰⁰
MIKROE-3745



Matrix RGB Click
Powered by a 32-bit FT900 MCU designed specifically for powering 16x32 RGB LED matrices.

MSRP - \$24⁰⁰
MIKROE-2239



UART MUX Click
It's the SN74LV4052A, a Dual 4-Channel Multiplexer and Demultiplexer.

MSRP - \$7⁰⁰
MIKROE-3878



RS232 SPI Click
It's a SPI to RS232 interface converter with two ICs - MAX3100 and MAX3232.

MSRP - \$22⁰⁰
MIKROE-3912



FT click
Features FT 6050 Free Topology Smart Transceiver from Dialog Semiconductor.

MSRP - \$39⁰⁰
MIKROE-3929





MCP2518FD click

Features MCP2518FD, CAN FD controller and ATA6563 CAN transceiver.

MSRP - \$25⁰⁰
MIKROE-3060



I2C MUX Click

The TCA9546A, a quad bidirectional translating I2C bus.

MSRP - \$7⁰⁰
MIKROE-4048



CAN FD Click

Features TLE9252V high speed CAN network transceiver from Infineon.

MSRP - \$21⁰⁰
MIKROE-3933



I2C MUX 2 Click

Uses the TCA9545A, a 4-channel, bidirectional translating I2C switch.

MSRP - \$7⁰⁰
MIKROE-4094



RS485 Isolator 2 Click

With the ADM2867E a 5.7 kV rms signal and power isolated full duplex RS-485 transceiver.

MSRP - \$29⁰⁰
MIKROE-3863



DMX Click

With the ADM2862E - Power Isolated RS-485 Transceiver and PIC18F26K42 MCU.

MSRP - \$29⁰⁰
MIKROE-4130



Monarch Adapter Click

Connects a compatible Monarch Go LTE-M modems from Sequans to a development board or prototype device.

MSRP - \$8⁰⁰
MIKROE-4057



RS485 5 Click

Equipped with the MAX485, low-power, slew-rate-limited transceiver.

MSRP - \$16⁰⁰
MIKROE-4156



M-Bus Slave Click

Equipped with the TSS721A, a single chip transceiver.

MSRP - \$15⁰⁰
MIKROE-4137



RF Switch Click

Uses the MASWSS0115 IC, a GaAs PHEMT MMIC single-pole, double-throw [SPDT] switch.

MSRP - \$14⁰⁰
MIKROE-4168



RS485 6 click

With the THVD1329DT a half-duplex RS-485 communication with integrated surge protection.

MSRP - \$16⁰⁰
MIKROE-3993



CAN FD 3 Click

Features TLE9251V, a High-Speed CAN transceiver from Infineon.

MSRP - \$15⁰⁰
MIKROE-3992



Analog MUX Click

With the CD74HC4067, a high-speed CMOS logic 16-channel analog multiplexer/demultiplexer.

MSRP - \$7⁰⁰
MIKROE-4111



CAN FD 4 Click

Features the NC-V7344D10R2G, a Controller Area Network [CAN] transceiver.

MSRP - \$7⁰⁰
MIKROE-4107



XPRO-Adapter click

Xplained Pro boards have one or more dual row, 20-pin, 100mil female extension header.

MSRP - \$12⁰⁰
MIKROE-4123



EXPAND 5 Click

Uses the TCA6424A IC, low-voltage 24-bit I2C, and SMBus I/O expander.

MSRP - \$12⁰⁰
MIKROE-4186



I2C Extend Click

Based on the LTC4331, which is a point-to-point compatible I2C slave device extender.

MSRP - \$19⁰⁰
MIKROE-4207



SPI Extend Click

SPI Extend Click is based on LTC4332, a 2MHz point-to-point SPI bus extender.

MSRP - \$19⁰⁰
MIKROE-4184



Single Wire CAN Click

Based on the NCV7356D1R2G, a Single Wire CAN transceiver.

MSRP - \$9⁰⁰
MIKROE-4225



I2C MUX 4 Click

Based on the LTC4306, a 4-channel, 2-wire bus multiplexer with bus buffers.

MSRP - \$7⁰⁰
MIKROE-4240

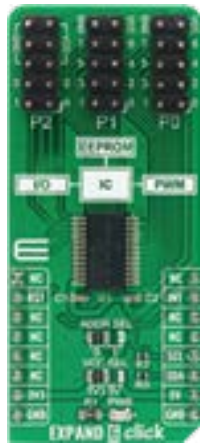

EXPAND 6 Click

The CY8C9520A, 20-bit I/O expander with EEPROM, and 4 independently config. 8-bit PWM outputs.

MSRP – \$15⁰⁰
MIKROE-4243



I2C MUX 3 Click

The TCA9548APWR, a low voltage eight bidirectional translating switches with an active-low reset input.

MSRP – \$7⁰⁰
MIKROE-4262



EXPAND 7 Click

The CY8C9540A, 40-bit I/O expander with EEPROM, and 8 independently config. 8-bit PWM outputs.

MSRP – \$24⁰⁰
MIKROE-4244



8-pin I2C Click

A breakout board that simplifies the connection of MFI devices to the mikroBUS™ socket.

MSRP – \$7⁰⁰
MIKROE-4241



CAN FD 5 Click

Based on the UJA1162A, a 'self-supplied' high-speed [HS] CAN transceiver.

MSRP – \$21⁰⁰
MIKROE-4286



Fingerprint 3 Click

An adapter with socket for the capacitive fingerprint sensor module scanner.

MSRP – \$6⁰⁰
MIKROE-4265



ISO 9141 Click

The L9637, a monolithic bus driver designed for serial comm. in automotive diagnostic applications.

MSRP – \$7⁰⁰
MIKROE-4331



CXPI Click

The BD41000AFJ-C, a transceiver for the Clock Extension Peripheral Interface [CXPI] communication.

MSRP – \$12⁰⁰
MIKROE-4336



I2C Extend 2 Click

The PCA9615, a Fast-Mode Plus [FM+] I2C bus buffer from NXP.

MSRP – \$17⁰⁰
MIKROE-4419



ATA6571 Click

A standalone high-speed CAN FD transceiver up to 5 Mbit/s from Microchip.

MSRP – \$23⁰⁰
MIKROE-4381



RS232 Isolator 2 Click

Uses the ICL3221, a 3.3V powered RS232 transmitter/receiver that provides ±15kV ESD protection.

MSRP – \$19⁰⁰
MIKROE-4536



UART MUX 2 Click

Features the MAX399, a precise CMOS analog multiplexer.

MSRP – \$27⁰⁰
MIKROE-4494



EtherCAT Click

2/3-Port EtherCAT® Slave Controller with Integrated Ethernet PHYs.

MSRP – \$37⁰⁰
MIKROE-2851



I2C MUX 5 Click

Based the LTC4306, a 4-channel, 2-wire bus multiplexer from Analog Devices.

MSRP – \$17⁰⁰
MIKROE-4453



SPI Isolator 2 Click

The ISO7741, a high-performance quad-channel digital isolator capable of galvanic isolation up to 5000Vrms.

MSRP – \$12⁰⁰
MIKROE-4415



I2C Isolator 3 Click

CPC5902 – a dual optically isolated bi-directional logic-bus repeater.

MSRP – \$12⁰⁰
MIKROE-4467



Binho Nova Click

Multi-protocol adapter, support for SPI I2C and UART interface, ideal for testing and validation.

MSRP – \$6⁰⁰
MIKROE-4439



ETH 3 Click

Uses the LAN9250, a fully-featured high-performance 10/100 Ethernet controller.

MSRP – \$39⁰⁰
MIKROE-2850



DISPLAY &
LED



OLED B Click

With a 96 x 39px blue monochrome passive matrix OLED display and SSD1351 OLED driver with controller and SSD1306 controller.

MSRP - \$24⁰⁰
MIKROE-1650



OLED C Click

With PSP27801 OLED display and SSD1351 OLED driver with controller. Various color support.

MSRP - \$29⁰⁰
MIKROE-1585



OLED W Click

Carries a 96x39px white monochrome passive matrix OLED display.

MSRP - \$24⁰⁰
MIKROE-1649



LCD mini Click

Displays 2x16 monochrome characters on an LMB162XFW LCD display.

MSRP - \$19⁰⁰
MIKROE-2453



OSD Click

With MAX7456 single-channel monochrome OSD module with integrated EEPROM memory.

MSRP - \$35⁰⁰
MIKROE-1366



Light Temp Click

The AL1782, a dual-channel PWM dimmable linear LED driver by Diodes Incorporated.

MSRP - \$17⁰⁰
MIKROE-3399

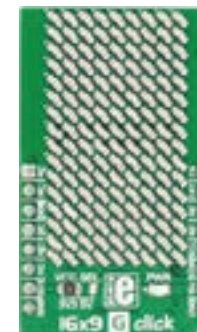

16x9 G Click

With a green 16x9 LED matrix and IS31FL3731 audio modulated matrix LED driver.

MSRP - \$34⁰⁰
MIKROE-2520



BarGraph 3 Click

Uses a single 74HC595 IC, a tri-state, serial-in, parallel-out, 8-bit shift-register with output latch.

MSRP - \$15⁰⁰
MIKROE-3264



4x4 RGB Click

With a matrix of 16 WS2812 RGB LEDs a MCP1826 low dropout regulator.

MSRP - \$19⁰⁰
MIKROE-1881



7-SEG RGB Click

Carries a full color single 7 segment digit display. 16,581,375 color combinations.

MSRP - \$29⁰⁰
MIKROE-2734



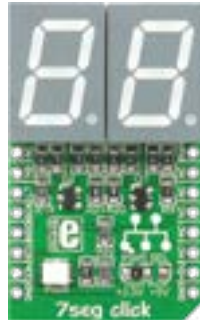

7seg Click

2-digit seven-seg display. With two 74HC595 8-bit serial-in, parallel-out shift registers.

MSRP - \$10⁰⁰
MIKROE-1201



7x10 B Click

With a matrix of 70 blue LEDs driven by a pair of 8-bit serial-in, parallel-out shift registers.

MSRP - \$15⁰⁰
MIKROE-2789



7x10 G Click

With a matrix of 70 green LEDs driven by a pair of 8-bit serial-in, parallel-out shift registers.

MSRP - \$15⁰⁰
MIKROE-2705



7x10 R Click

With a matrix of 70 red LEDs driven by a pair of 8-bit serial-in, parallel-out shift registers.

MSRP - \$15⁰⁰
MIKROE-1993



7x10 Y Click

With a matrix of 70 yellow LEDs driven by a pair of 8-bit serial-in, parallel-out shift registers.

MSRP - \$15⁰⁰
MIKROE-2790

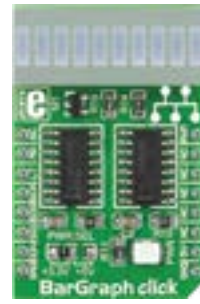

BarGraph Click

With 10-segment JSB-R102510Z light bar display and two 74HC595 8-bit shift registers.

MSRP - \$12⁰⁰
MIKROE-1423

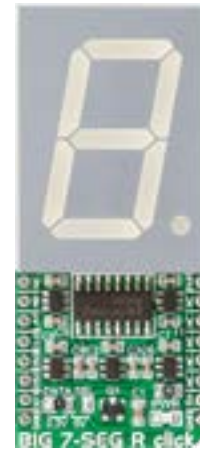

BIG 7-SEG R Click

With SC10-21SR-WA seven-segment display and parallel-OUT shift register 74HC595.

MSRP - \$19⁰⁰
MIKROE-2269



eINK Click

With an adapter for connecting eINK displays, with a 24pin ribbon cable.

MSRP - \$59⁰⁰
MIKROE-2659



EVE Click

Brings visually stunning graphics even to 8-bit MCUs, with FT800Q graphics controller.

MSRP - \$39⁰⁰
MIKROE-1430



Matrix G Click

Matrix text display with two green 5x7 matrices and two MAX7219 8-bit LED display drivers.

MSRP - \$29⁰⁰
MIKROE-2246



16x12 G Click

Carries a 16x12 LED display and the IS-31FL3733 matrix driver with 1/12 cycle rate.

MSRP - \$30⁰⁰
MIKROE-2758



8x8 B Click

It features MAX7219 8-digit LED display driver module as well as 64 BLUE LEDs.

MSRP - \$18⁰⁰
MIKROE-1307



8x8 G Click

It features MAX7219 8-digit LED display driver module as well as 64 GREEN LEDs.

MSRP - \$15⁰⁰
MIKROE-1306



8x8 R Click

It features MAX7219 8-digit LED display driver module as well as 64 RED LEDs.

MSRP - \$15⁰⁰
MIKROE-1295



8x8 Y Click

It features MAX7219 8-digit LED display driver module as well as 64 YELLOW LEDs.

MSRP - \$15⁰⁰
MIKROE-1294



LED Flash Click

Functions as a high power LED flash, and carries the CAT3224 flash LED driver.

MSRP - \$34⁰⁰
MIKROE-2479



LED Flash 2 Click

It is a powerful flash/torch Click, featuring the MIC2870 from Microchip.

MSRP - \$19⁰⁰
MIKROE-2830



Led ring R Click

With a ring of 32 red LEDs driven by four 74HC595 serial-in, parallel-out shift registers.

MSRP - \$16⁰⁰
MIKROE-2153



AlphaNum R Click

With a dual character red LED 14-segment display and two TLC5926 16-bit shift registers.

MSRP - \$15⁰⁰
MIKROE-1864

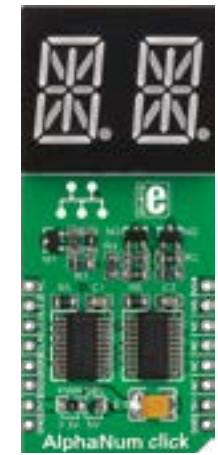

AlphaNum G Click

With a dual character green LED 14-segment display and two TLC5926 16-bit shift registers.

MSRP - \$15⁰⁰
MIKROE-1851



Matrix R Click

Matrix text display with two red 5x7 matrices and two MAX7219 8-bit LED display drivers.

MSRP - \$29⁰⁰
MIKROE-2245



4Dot-Matrix R Click

Displays 4 char. of 5x7 dot size. With SLO2016 module and MCP23017 I2C port expander.

MSRP - \$59⁰⁰
MIKROE-2706



UT-L 7-SEG R Click

With two SMD ultra-thin LED 7-SEG displays and MAX6969 constant-current LED driver.

MSRP - \$44⁰⁰
MIKROE-2034



UT-M 7-SEG R Click

Add a double 7 segment display to your next project. RED emitting color.

MSRP - \$20⁰⁰
MIKROE-2746



UT-S 7-SEG R Click

For displaying characters on two 7 segment displays. RED emitting color.

MSRP - \$20⁰⁰
MIKROE-2840



LED Driver 7 Click

The AL1781, a single-channel PWM dimmable linear LED driver by Diodes Incorporated.

MSRP - \$23⁰⁰
MIKROE-3917



LCD Mono Click

The LS013B7DH03 LCD has an active-matrix memory liquid crystal display module with 128x128 panel.

MSRP - \$65⁰⁰
MIKROE-3789



MCP1664 Click

With 4 high-power white LEDs. Carries Microchip's MCP1664, a high-voltage step-up LED driver.

MSRP - \$26⁰⁰
MIKROE-2548



LED Driver Click

Carries MCP1662 high-voltage step-up voltage driver from Microchip.

MSRP - \$15⁰⁰
MIKROE-2676



LED Driver 2 Click

Carries the MCP1643 - LED constant current regulator, made by Microchip.

MSRP - \$15⁰⁰
MIKROE-2807



OLED Switch Click

With NKK Switch IS-C15ANP4 that combines a switch and a full color organic LED display.

MSRP - \$99⁰⁰
MIKROE-2449



BarGraph 2 Click

The 74HC595, 8-bit serial-in, parallel-out shift registers with output latches.

MSRP - \$19⁰⁰
MIKROE-3021



RGB Driver Click

The NCP5623B, a triple output RGB LED driver, controlled via the I2C interface, from ON Semiconductor.

MSRP - \$15⁰⁰
MIKROE-3078



LED Driver 5 Click

The TPS54200, a synchronous buck converter designed to drive monochrome, color, and IR LED arrays by TI.

MSRP - \$15⁰⁰
MIKROE-3297



LED Driver 6 Click

The AL1781, a single-channel PWM dimmable linear LED driver by Diodes Incorporated.

MSRP - \$15⁰⁰
MIKROE-3400



LED Driver 3 Click

The NCP5623B, a triple output RGB LED driver, controlled through the I2C protocol.

MSRP - \$15⁰⁰
MIKROE-2950



LED Driver 4 Click

The TPS61160A, a white LED driver with PWM brightness control.

MSRP - \$39⁰⁰
MIKROE-3037



10x10 RGB Click

A matrix of 100 "intelligent" RGB elements - WS2812, an intelligent control LED light source.

MSRP - \$35⁰⁰
MIKROE-4115



UVC Light Click

With ultraviolet LEDs with 275nm wavelength for measuring exact dose of UV radiation.

MSRP - \$39⁰⁰
MIKROE-4177

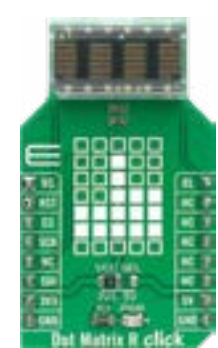

Dot Matrix R Click

Based on a four-digit dot matrix display module, labeled as HCMS-3906.

MSRP - \$55⁰⁰
MIKROE-4169



LED Driver 8 Click

The PCA9957, a daisy-chain SPI compatible 4-wire serial bus controlled 24-channel LED driver.

MSRP - \$7⁰⁰
MIKROE-4268



HUMAN MACHINE INTERFACE



Cap Extend 3 Click

With four capacitive sensor pads that can sense touch through a variety of different materials.

MSRP - \$16⁰⁰
MIKROE-2474



Cap Touch Click

A capacitive touch sensing button, integrated on a Click board™.

MSRP - \$16⁰⁰
MIKROE-2888



SwipeSwitch Click

The IQS266, a trackpad controller circuit, featuring ProxSense® and IQ Switch® technologies, from Azoteq.

MSRP - \$15⁰⁰
MIKROE-3202



CAP Wheel 2 Click

The IQS263B, ProxSense® IC, a 3-channel projected capacitive proximity and TC from Azoteq.

MSRP - \$15⁰⁰
MIKROE-3677



CAP Wheel Click

The IQS333, ProxSense® IC, a 9-channel projected capacitive proximity and TC from Azoteq.

MSRP - \$15⁰⁰
MIKROE-3203



Cap Touch 2 Click

A capacitive touch sensing button, which features the CAP1166.

MSRP - \$15⁰⁰
MIKROE-2964



TouchKey 2 Click

With 4 capacitive pads powered by Microchip's ATtiny817. Integrated touch QTouch® controller.

MSRP - \$16⁰⁰
MIKROE-2474



TouchKey 3 Click

Equipped with advanced capacitive sensors, based on the proprietary QTouch® technology.

MSRP - \$19⁰⁰
MIKROE-2405



SAML Touch Click

The ATSAML10, an ultra-low power 32-bit ARM® Cortex® MicroController Unit (MCU) from Microchip.

MSRP - \$15⁰⁰
MIKROE-3414



TouchKey 4 Click

A capacitive touch sensing button, with the advanced touch/proximity sensor IC.

MSRP - \$15⁰⁰
MIKROE-2965





Tamper Click

Equipped with SDS001, a low profile side-actuated detect switch.

MSRP - \$9⁰⁰
MIKROE-2551



Button PLAY Click

It is equipped with the CTHS15CIC05ARROW, a capacitive touch sensor display.

MSRP - \$21⁰⁰
MIKROE-3327



Knob G Click

Combination of high-quality quadrature rotary encoder, and a LED ring of 24 individual green LEDs.

MSRP - \$17⁰⁰
MIKROE-3299



Slider Click

Features a mechanical slide action potentiometer.

MSRP - \$24⁰⁰
MIKROE-2702



Tamper 2 Click

Levered D2HW-A221D switch. Outputs signal in both positions - pressed and released.

MSRP - \$15⁰⁰
MIKROE-2552



Joystick Click

A smart navigation key concept based on contactless, magnetic movement detection.

MSRP - \$22⁰⁰
MIKROE-1506



Keylock Click

Carries a processed sealed key lock mechanism that can be set in 3 different positions.

MSRP - \$25⁰⁰
MIKROE-2564



CapSense Click

Capacitive sensing module. Input- human body capacitance, output - the real time sensor information.

MSRP - \$16⁰⁰
MIKROE-1446



COUNTER Click

Counter Click carries an LS7366R 32-bit quadrature counter.

MSRP - \$25⁰⁰
MIKROE-1917



IR gesture Click

Enables contactless gesture recognition. With ambient light and proximity sensing capabilities.

MSRP - \$16⁰⁰
MIKROE-2086

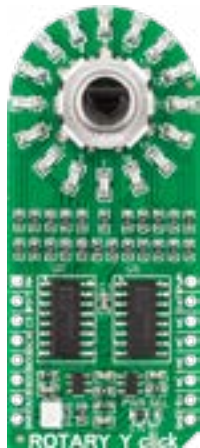

ROTARY Y Click

With a 15-pulse incremental rotary encoder with detents, surrounded by a ring of 16 yellow LEDs.

MSRP - \$12⁰⁰
MIKROE-1825

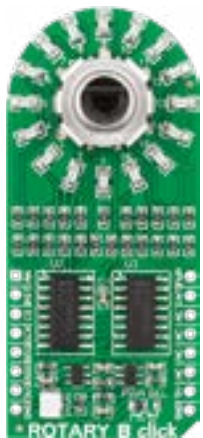

ROTARY B Click

With a 15-pulse incremental rotary encoder with detents, surrounded by a ring of 16 blue LEDs.

MSRP - \$12⁰⁰
MIKROE-1824

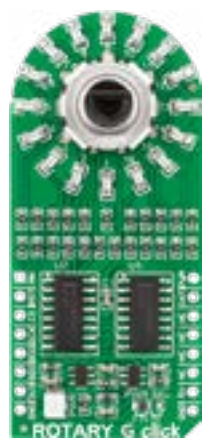

ROTARY G Click

With a 15-pulse incremental rotary encoder with detents, surrounded by a ring of 16 green LEDs.

MSRP - \$12⁰⁰
MIKROE-1822



ROTARY O Click

With a 15-pulse incremental rotary encoder with detents, surrounded by a ring of 16 orange LEDs.

MSRP - \$12⁰⁰
MIKROE-2380

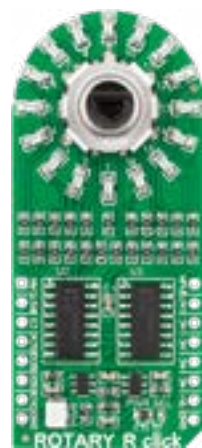

ROTARY R Click

With a 15-pulse incremental rotary encoder with detents, surrounded by a ring of 16 red LEDs.

MSRP - \$12⁰⁰
MIKROE-1823



2x2 Key Click

The Click has a 4 button keypad. It allows multiple key presses and has a debounce circuit.

MSRP - \$9⁰⁰
MIKROE-2152



4x4 Key Click

Carries a 16 button keypad. Allows for multiple key presses at the same time.

MSRP - \$11⁰⁰
MIKROE-1889



Button G Click

A single pushbutton - transparent, 6.8mm in diameter, with a green LED backlight.

MSRP - \$9⁰⁰
MIKROE-2040



Button R Click

A single pushbutton - transparent, 6.8mm in diameter, with a red LED backlight.

MSRP - \$9⁰⁰
MIKROE-1901



Cap Extend Click

With SX8633, capacitive button touch controller. 12 pins for connecting capacitive inputs.

MSRP - \$18⁰⁰
MIKROE-2238





Thumb wheel Click
 With a 10-position rotary sprocket connected to a 1-Wire 8-Channel Addressable Switch.
 MSRP - \$29⁰⁰
 MIKROE-2366



TouchClamp Click
 With NXP's MPR121 proximity capacitive touch sensor controller. 7 plated holes for clamps.
 MSRP - \$9⁰⁰
 MIKROE-2294



Thumbstick Click
 A high precision input device with a dual axis, spring return and push-button enabled joystick.
 MSRP - \$20⁰⁰
 MIKROE-1627



Touchpad Click
 Capacitive touch input device driven by Microchip's MTCH6102 controller.
 MSRP - \$15⁰⁰
 MIKROE-1995



TouchKey Click
 It has four capacitive pads powered by TTP224, a touchpad detector IC.
 MSRP - \$12⁰⁰
 MIKROE-1906



Button ALARM Click
 With the CTHS15CI-C05ALARM, a capacitive touch sensor display.
 MSRP - \$21⁰⁰
 MIKROE-3763



Button Power Click
 With the CTH-S15CIC05ONOFF, a capacitive touch sensor display.
 MSRP - \$19⁰⁰
 MIKROE-3740



Cap Touch 5 Click
 Features the CY-8CMBR3106S-LQXI CapSense® Express™ controller.
 MSRP - \$15⁰⁰
 MIKROE-3786



Joystick 2 Click
 With a SKRHABE01, a 4-direction joystick switch with Center-push Function.
 MSRP - \$15⁰⁰
 MIKROE-3711



Power/Reset Click
 It's the QT1011, digital burst mode charge-transfer sensor - detects near proximity or touch.
 MSRP - \$7⁰⁰
 MIKROE-3771



Keylock 2 Click
 Uses SK13AEG13 switch keylock from the company NKK Switches.
 MSRP - \$28⁰⁰
 MIKROE-3471



POT Click
 The MCP1501, a precision voltage reference IC from Microchip.
 MSRP - \$12⁰⁰
 MIKROE-3402



ProxFusion® 2 Click
 The IQS621, a multi-functional sensor with the ambient light [ALS] from Azoteq.
 MSRP - \$9⁰⁰
 MIKROE-3205

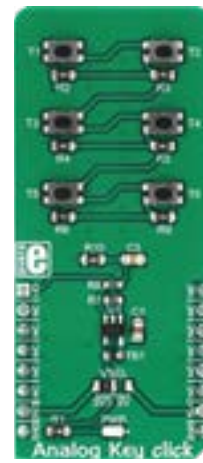

Analog Key Click
 The KMR2 series KMR221 tactile buttons are high-quality SPST switches produced by CKSwitches.
 MSRP - \$14⁰⁰
 MIKROE-3409



Button Y Click
 Designed with the high-quality, single-pole, single-throw [SPST] tactile switch labeled as 3006.2111.
 MSRP - \$9⁰⁰
 MIKROE-3262



Vibro Motor 2 Click
 With the ERM motor. Uses the DMG3420U MOSFET to drive it.
 MSRP - \$12⁰⁰
 MIKROE-3713



HAPTIC Click
 With DRV2605 Haptic Driver for ERM and LRA vibration motors. Over 100 haptic effects library.
 MSRP - \$23⁰⁰
 MIKROE-2025



Vibro Motor Click
 Features a compact size Eccentric Rotating Mass [ERM] motor, labeled as C1026B002F.
 MSRP - \$12⁰⁰
 MIKROE-2826



Fingerprint Click
 It carries the GTS-511E2 module, the thinnest optical touch fingerprint sensor in the world.
 MSRP - \$55⁰⁰
 MIKROE-1722



Slider 2 Click
 Utilizes the PTA3043, a linear, high-grade, 10K potentiometer
 MSRP - \$20⁰⁰
 MIKROE-3301





POT 2 Click

The MCP1541, a precision voltage reference IC from Microchip is used to provide the voltage of 4.096V.

MSRP - \$12⁰⁰
MIKROE-3325



ProxFusion 3 Click

Features the IQS2692A, an 8-channel ProxFusion® capacitive touch and proximity controller.

MSRP - \$12⁰⁰
MIKROE-4469



Fingerprint 2 Click

The A-172-MRQ, a 2D capacitive fingerprint sensor capable of storing up to 24 different fingerprints.

MSRP - \$45⁰⁰
MIKROE-4119



Vibro Motor 3 Click

Features the G0832022D, a coin-sized linear resonant actuator (LRA).

MSRP - \$15⁰⁰
MIKROE-4356



HAPTIC 2 Click

The LC898302AXA, a motor driver dedicated to LRA and ERM applications.

MSRP - \$7⁰⁰
MIKROE-4452



TouchPad 3 Click

Features the MTCH6301, a turnkey capacitive touch controller.

MSRP - \$11⁰⁰
MIKROE-4382



POT 3 Click

The MCP1501, a precision voltage reference IC from Microchip.

MSRP - \$25⁰⁰
MIKROE-3691

STORAGE

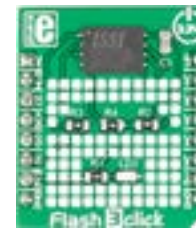

Flash 3 Click

With ISSI's IS25LP128 IC with 128 Mbit capacity, 50MHz at Normal, 133MHz at Fast Read speeds.

MSRP - \$12⁰⁰
MIKROE-2374



Flash 4 Click

Carries the S25FL512S, a 512 Mbit SPI Flash memory module.

MSRP - \$25⁰⁰
MIKROE-3191



Excelon-LP Click

Equipped with the CY-15B108Q, a serial ferroelectric (FRAM) module with 8 Mbit density.

MSRP - \$25⁰⁰
MIKROE-3104



MAC Address Click

A unique node address. Carries 24AA025E64 2Kb Serial EEPROM with EUI-64™ node identity.

MSRP - \$9⁰⁰
MIKROE-2733



microSD Click

With a microSD card slot for microSD cards used as a mass storage media for portable devices.

MSRP - \$16⁰⁰
MIKROE-924



FRAM 2 Click

With CY15B104Q 4-Mbit (512K x 8) serial F-RAM from Cypress. 100 trillion (10¹⁴) read/writes.

MSRP - \$19⁰⁰
MIKROE-2768



EEPROM Click

With 24C08WP - a highly reliable, high performance CMOS technology serial 8K EEPROM.

MSRP - \$8⁰⁰
MIKROE-1200



EEPROM 2 Click

With M95M02-DR DIP-8 socket EEPROM chip with 256 KB of memory from STMicroelectronics.

MSRP - \$18⁰⁰
MIKROE-1909



EEPROM 3 Click

With AT24CM02 DIP-8 socket EEPROM chip with 256 KB of memory from Microchip.

MSRP - \$14⁰⁰
MIKROE-1989



EERAM 3.3V Click

With 47L16 EERAM, a 16Kbit SRAM with EEPROM Backup from Microchip.

MSRP - \$14⁰⁰
MIKROE-2728



**EERAM 5V Click**

With 47C16 EERAM, a 16Kbit SRAM with EEPROM Backup from Microchip.

MSRP – \$14⁰⁰
MIKROE-2729

**Flash Click**

With EN25Q80B - 8Mb serial Flash memory module. Clock frequency up to 75MHz.

MSRP – \$10⁰⁰
MIKROE-1199

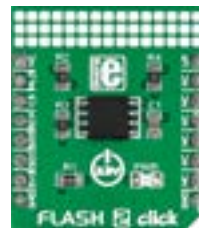
**Flash 2 Click**

It carries Microchip's SST26VF064B flash-memory module with 64 Mbits capacity.

MSRP – \$12⁰⁰
MIKROE-2267

**MRAM Click**

Uses the MR25H256, a 256 kilobits serial SPI MRAM memory module from Everspin company.

MSRP – \$18⁰⁰
MIKROE-2914

**Dual EE Click**

Contains 2 EEPROM ICs onboard – the AT24CM02, an I2C serial EEPROM.

MSRP – \$18⁰⁰
MIKROE-3762

**EEPROM 4 Click**

An EEPROM memory medium with the capacity of 256KB.

MSRP – \$15⁰⁰
MIKROE-2536

**ReRAM Click**

Resistive Random Access Memory module which contains the cell array with 4 Mbits of data.

MSRP – \$18⁰⁰
MIKROE-3641

**FRAM Click**

256K [32,768 words x 8 bits] of Ferroelectric Random Access Memory with MB85RS256A module.

MSRP – \$15⁰⁰
MIKROE-1486

**Semper Flash 2 Click**

The S25HL512T, a 512 Mbit SPI/QSPI Flash memory module, from Cypress.

MSRP – \$25⁰⁰
MIKROE-4028

**Flash 6 Click**

The W25Q128JV array is organized into 65,536 programmable pages of 256-bytes each.

MSRP – \$7⁰⁰
MIKROE-4067

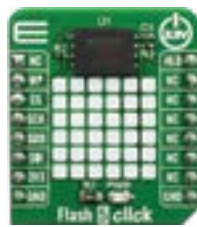
**Flash 5 Click**

Based on the W25N01GVZEIG/IT [1G-bit] Serial SLC NAND Flash Memory.

MSRP – \$9⁰⁰
MIKROE-3780

**FRAM 3 Click**

Uses the MB94R330, which is an FRAM [Ferroelectric Random Access Memory].

MSRP – \$9⁰⁰
MIKROE-3817

**Semper Flash Click**

Memory module based on the S25HS512T a 512 Mbit SPI Flash memory module, from Cypress.

MSRP – \$25⁰⁰
MIKROE-3823

**SRAM Click**

Provides 1 Mbit of additional SRAM memory, via Microchip's 23LC1024.

MSRP – \$15⁰⁰
MIKROE-1902

**SQI FLASH Click**

Based on the SST-26VF064B, a 64 Mbit Serial Quad I/O flash device from Microchip.

MSRP – \$13⁹⁰
MIKROE-2828

**EERAM 2 Click**

A static RAM [SRAM] memory Click board™ with hidden EEPROM backup.

MSRP – \$14⁰⁰
MIKROE-4129

**SRAM 2 Click**

Based on ANV32A62A SRAM memory from Anvo-Systems Dresden.

MSRP – \$15⁰⁰
MIKROE-4178

**MRAM 2 Click**

Features the MR10Q010, 1Mb Quad Output High-Speed Serial SPI MRAM memory.

MSRP – \$19⁰⁰
MIKROE-4232

**SRAM 3 Click**

The ANV32AA1WDK66, a 1Mb serial SRAM with a non-volatile SONOS storage element.

MSRP – \$19⁰⁰
MIKROE-4293

**EEPROM 6 Click**

The DS28EC20, a 20480-bit EEPROM organized as 80 memory pages of 256 bits each.

MSRP – \$9⁰⁰
MIKROE-4296





Flash 7 Click

With the GD25LQ16C, a high-performance 16Mbit SPI NOR Flash Memory solution.

MSRP - \$9⁰⁰
MIKROE-4440



nvSRAM Click

The CY14B101J, a 1-Mbit nvSRAM organized as 128K words of 8 bits each.

MSRP - \$24⁰⁰
MIKROE-4441



nvSRAM 2 Click

the CY14B101Q, a 1Mbit nvSRAM organized as 128K words of 8 bits each.

MSRP - \$24⁰⁰
MIKROE-4423



nvSRAM 3 Click

Features the CY14B101I, a 1-Mbit nvSRAM organized as 128K words of 8 bits each.

MSRP - \$27⁰⁰
MIKROE-4497



nvSRAM 4 Click

The CY14B101PA, a 1-Mbit nvSRAM with a fully-featured real-time clock.

MSRP - \$29⁰⁰
MIKROE-4482



EEPROM 7 Click

The 25CSD04, a 4-Mbit SPI Serial EEPROM with a 128-bit serial number and write protection mode.

MSRP - \$12⁰⁰
MIKROE-4421



EEPROM 5 Click

Features the M95M04, the 4Mbit electrically erasable programmable memory.

MSRP - \$9⁰⁰
MIKROE-4422



SWI EEPROM Click

The AT21CS01, a single-wire serial EEPROM with a factory-programmed 64-bit serial number.

MSRP - \$7⁰⁰
MIKROE-4521

MISCELLANEOUS





Secure Click

With ATECC508A cryptographic coprocessor with secure hardware-based key storage.

MSRP - \$9⁰⁰
MIKROE-2522



Secure 2 Click

Microchip's ATAES132A, a cryptographic coprocessor with secure hardware-based key storage.

MSRP - \$9⁰⁰
MIKROE-2760



Secure 3 Click

Microchip's ATSHA204A, a cryptographic coprocessor with secure hardware-based key storage.

MSRP - \$9⁰⁰
MIKROE-2761



Secure 4 Click

Includes the ATECC608A, a secure CryptoAuthentication™ device from Microchip.

MSRP - \$9⁰⁰
MIKROE-2829



Secure 5 Click

The ATECC508A integrates ECDH [Elliptic Curve Diffie Hellman] security protocol.

MSRP - \$7⁰⁰
MIKROE-3774



Secure 6 Click

The ATSHA204A implements a complete asymmetric key cryptographic signature solution.

MSRP - \$7⁰⁰
MIKROE-3699



Secure 7 Click

The ATECC608A integrates ECDH [Elliptic Curve Diffie Hellman] security protocol.

MSRP - \$7⁰⁰
MIKROE-3915



RELAY Click

With two G6D1AA-SI-5DC power PCB relay modules. Controls up to 5A, 250V AC/30V DC loads.

MSRP - \$18⁰⁰
MIKROE-1370



Relay 2 Click

Carries two LCA717 single-pole, OptoMOS® solid state relays.

MSRP - \$26⁰⁰
MIKROE-1899



PROTO Click

10x11 prototyping area and additional power pads for creating custom electronics or Click boards™.

MSRP - \$4⁵⁰
MIKROE-1507





FLICKER Click

TI's NA556 dual precision timer and Omron's G6D-ASI power PCB relay. ON/OFF 0.1-6 sec.

MSRP - \$19⁰⁰
MIKROE-2481



Signal Relay Click

It carries four ultra-small GV5-1 PCB relays from Omron. For ON/OFF control.

MSRP - \$29⁰⁰
MIKROE-2154



UNIQUE ID Click

With DS2401 enhanced silicon serial number IC. Provides a unique registration number.

MSRP - \$9⁰⁰
MIKROE-1819



TESTER Click

An ideal solution for testing and diagnostics of the mikroBUS™ socket pin states.

MSRP - \$6⁰⁰
MIKROE-3083



Opto 2 Click

Uses four TLP2770, 20-Mbps low-power optocouplers, from Toshiba.

MSRP - \$25⁰⁰
MIKROE-3015



Opto Click

It features two V02630 dual channel, high speed optocoupler modules.

MSRP - \$21⁰⁰
MIKROE-1196



Opto 5 Click

Features the FOD4216, a random phase snubberless Triac driver.

MSRP - \$15⁰⁰
MIKROE-4476



RNG Click

The NC7S14M5X inverter, and the ADS1115 - 16BIT sigma-delta ADC.

MSRP - \$15⁰⁰
MIKROE-4090



Trust M Click

It's based on SLS 32AIA010 OPTIGA™ Trust M1 high-end security controller.

MSRP - \$8⁰⁰
MIKROE-4236



Opto 3 Click

Two pairs of normally opened, high-quality solid-state relays labeled as TLP241A.

MSRP - \$21⁰⁰
MIKROE-3319



Secure SOIC Click

It's an universal socket that supports any Microchip security SOIC IC device.

MSRP - \$39⁰⁰
MIKROE-3788



Secure UDFN Click

The 08QN50L43020 is an universal socket that supports basically any 8-pin UDFN device.

MSRP - \$69⁰⁰
MIKROE-3746



Relay 3 Click

It features two SRD-05VDC-SL-C small-size relays, from Songle Relays.

MSRP - \$18⁰⁰
MIKROE-3357



Opto 4 Click

The LTV-817S, an optocoupler with a high isolation voltage, by LITEON.

MSRP - \$16⁰⁰
MIKROE-3337



MOTOR CONTROL



Brushless 6 Click

Designed to drive a three-phase sensorless, brushless motor. With ATmega8A from Microchip.

MSRP - \$27⁰⁰
MIKROE-2847



Fan 3 Click

Perfect solution for speed control. It can operate in seven discrete speed steps.

MSRP - \$17⁰⁰
MIKROE-2841



DC Motor 8 Click

The MIC4605, 85V half-bridge MOSFET driver with adaptive dead time and shoot-through protection.

MSRP - \$18⁰⁰
MIKROE-2893



Stepper 7 Click

MTS62C19A Dual Full-Bridge Motor Driver, MCP23S08 8bit I/O Expander with Serial Interface.

MSRP - \$17⁰⁰
MIKROE-2912



Brushless 4 Click

The MCP8063, a 3 phase brushless sinusoidal sensorless motor driver, from Microchip.

MSRP - \$19⁰⁰
MIKROE-3019



H-Bridge Click

Uses the MC34933, a dual H-bridge driver, from NXP.

MSRP - \$16⁰⁰
MIKROE-3031



H-Bridge 2 Click

Uses the MPC17510, an H-Bridge DC motor driver, with up to 15V and 1.2A, from NXP.

MSRP - \$18⁰⁰
MIKROE-3000



Brushless 5 Click

Uses the A4941, a three-phase sensorless fan driver IC, made by Allegro MicroSystems LLC.

MSRP - \$19⁰⁰
MIKROE-3032



Stepper 5 Click

Uses the TM2208, a highly integrated bipolar step motor power driver, with the UART interface.

MSRP - \$17⁰⁰
MIKROE-2624



Driver Click

The DRV777, an integrated motor and relay driver from Texas Instruments.

MSRP - \$13⁰⁰
MIKROE-3109





Servo Click

A 16-channel PWM servo driver with the voltage sensing circuitry.

MSRP – \$25⁰⁰
MIKROE-3133



FAN 4 Click

A two-wire fan driver. Utilizes the LTC1695, an I2C fan speed controller.

MSRP – \$15⁰⁰
MIKROE-3200



DC MOTOR 7 Click

Advanced PWM chopper-type integrated DC motor driver, labeled as TB67H400AFTG.

MSRP – \$19⁰⁰
MIKROE-3289



DC MOTOR 9 Click

The DR8871, a brushed DC motor driver, with internal current sensing, by Texas Instruments.

MSRP – \$18⁰⁰
MIKROE-3416



DC MOTOR 11 Click

The DRV8830, a Low-Voltage Motor Driver With Serial Interface, by Texas Instruments.

MSRP – \$15⁰⁰
MIKROE-3649



DC MOTOR 3 Click

With Toshiba's TB-6549FG full-bridge driver for direct current motors. Up to 3.5A with 30V.

MSRP – \$19⁰⁰
MIKROE-2047



DC MOTOR 4 Click

With MAX14870 motor driver from Maxim Integrated. Motors' voltage supply 4.5V-36V.

MSRP – \$15⁰⁰
MIKROE-2221



DC MOTOR 5 Click

With TI's DRV8701 brushed DC motor full-bridge gate driver. Operating voltage supply 5.9V-45V.

MSRP – \$17⁰⁰
MIKROE-2699



FAN Click

With EMC2301 controller for powering and regulating the operation of 5V four-wire fans.

MSRP – \$9⁰⁰
MIKROE-2004



Fan 2 Click

With MAX31760 precision fan-speed controller. Can control two fans at the same time.

MSRP – \$12⁰⁰
MIKROE-2708



Brushless Click

Toshiba's TB6575F-NG IC for driving 3-phase full-wave Brushless DC motors.

MSRP – \$39⁰⁰
MIKROE-2441



Brushless 2 Click

It carries TI's DRV10964 BLDC motor controller with an integrated output stage.

MSRP – \$26⁰⁰
MIKROE-2754



Brushless 3 Click

With TI's DRV10983 three-phase sensorless motor driver with integrated power MOSFETs.

MSRP – \$19⁰⁰
MIKROE-2766



DC MOTOR Click

With TI's DRV8833RTYH-Bridge motor driver and TI's 74HC4053 multiplexer.

MSRP – \$18⁰⁰
MIKROE-1526



DC MOTOR 2 Click

With Toshiba's TB6593F-NG driver IC for direct current motors. Motors' supply voltage 2.5V-13V.

MSRP – \$17⁰⁰
MIKROE-2699



PWM driver Click

Silicon Labs' Si8711CC one-channel isolator for controlling DC motors with loads up to 10A.

MSRP – \$14⁰⁰
MIKROE-2272



STEPPER Click

With A3967SLBT microstepping motor driver with a built-in translator. Max. output drive 30V, ±500 mA.

MSRP – \$18⁰⁰
MIKROE-1528



STEPPER 2 Click

With A4988 microstepping motor driver. Required external power supply minimum 7V.

MSRP – \$19⁰⁰
MIKROE-1926



STEPPER 3 Click

With TI's ULN2003 High-Current Darlington transistor array. For precise motor control.

MSRP – \$19⁰⁰
MIKROE-2035



STEPPER 4 Click

With TB67S269FTG two-phase bipolar stepping motor driver from Toshiba.

MSRP – \$19⁰⁰
MIKROE-2748





Stepper 6 Click

The DRV8886, a highly integrated bipolar step motor driver with current sensing, from TI.

MSRP - \$23⁰⁰
MIKROE-3214



DC MOTOR 10 Click

The TLE 6208-6 G, a Hex-Half-Bridge-Driver made for auto. and industrial motion control app.

MSRP - \$17⁰⁰
MIKROE-3879



Fan 6 Click

The EMC2103 includes an RPM based Fan Speed Control Algorithm.

MSRP - \$16⁰⁰
MIKROE-3867



Silent Step Click

The TMC5130 - the universal high voltage controller/driver for 2-phase bipolar stepper motor.

MSRP - \$24⁰⁰
MIKROE-3714



Stepper 13 Click

The step motor driver IC is the MP6500, a dual full-bridge motor driver.

MSRP - \$15⁰⁰
MIKROE-3736



H-Bridge 3 Click

The TLE9201SG, an H-Bridge DC motor driver, with up to 28V and 6A, from Infineon.

MSRP - \$18⁰⁰
MIKROE-3613



H-Bridge 4 Click

Contains the AP1010AEN, which is a two channel H-Bridge motor driver.

MSRP - \$15⁰⁰
MIKROE-3787



H-Bridge 5 Click

Contains the MP6515GF-Z, a H-bridge motor driver from MPS.

MSRP - \$15⁰⁰
MIKROE-3854



Silent Step 3 Click

Uses the TMC2660, a highly integrated bipolar step motor power driver.

MSRP - \$27⁰⁰
MIKROE-3676



DC Motor 14 Click

The TB67H450FNG, a PWM chopper-type brushed DC motor driver.

MSRP - \$14⁰⁰
MIKROE-3982



STSPIN220 Click

The STSPIN220, a low voltage stepper motor driver by STMicroelectronics.

MSRP - \$17⁰⁰
MIKROE-3545



STSPIN250 Click

The STSPIN250, a brushed DC motor driver with the current limiting and current sensing.

MSRP - \$14⁰⁰
MIKROE-3543



STSPIN820 Click

The STSPIN820, an advanced stepper motor driver produced by STMicroelectronics.

MSRP - \$17⁰⁰
MIKROE-3544



STSPIN233 Click

The step motor driver IC is the MP6500, a dual full-bridge motor driver.

MSRP - \$17⁰⁰
MIKROE-3546



Driver Click

The TMC2660, a highly integrated bipolar step motor power driver, from the Trinamic company.

MSRP - \$27⁰⁰
MIKROE-3676



DC Motor 6 Click

The TB67H451FNG, a PWM chopper-type brushed DC motor driver.

MSRP - \$12⁰⁰
MIKROE-4114



Stepper 8 Click

Based on TC78H-670FTG a clock-in and serial controlled Bipolar Stepping Motor Driver.

MSRP - \$15⁰⁰
MIKROE-4157



H-Bridge 7 Click

Uses the DRV8876N IC, N-channel H-bridge motor driver.

MSRP - \$12⁰⁰
MIKROE-4143



Stepper 10 Click

Uses the TB67S128FTG a two-phase bipolar stepper motor driver.

MSRP - \$29⁰⁰
MIKROE-4138



Stepper 14 Click

Features the DRV8847PWPR, a step motor driver with bipolar step motor controle.

MSRP - \$15⁰⁰
MIKROE-4125





Brushless 7 Click

Based on TC78B-009FTG IC which is a three-phase BLDC motor controller.

MSRP - \$25⁰⁰
MIKROE-4182

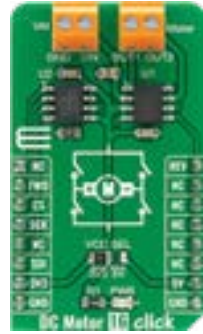

DC Motor 16 Click

The ZXBM5210 a high-performance single phase reversible DC motor drive with speed control.

MSRP - \$9⁰⁰
MIKROE-4333



DC Motor 15 Click

Features the DRV8874, an integrat-ed motor driver with N-channel H-bridge.

MSRP - \$15⁰⁰
MIKROE-4334



Driver 2 Click

Features the IR2104S, a high voltage, high-speed power MOSFET and IGBT driver.

MSRP - \$15⁰⁰
MIKROE-4352



H-Bridge 6 Click

Features the VN-HD7008AY, an H-bridge motor driver for auto-motive DC motor.

MSRP - \$29⁰⁰
MIKROE-4289



Brushless 12 Click

Features the L6235, DMOS fully integrated 3-phase motor driver.

MSRP - \$29⁰⁰
MIKROE-4357



DC Motor 17 Click

Features the TC78H-660FTG, a dual H Bridge driver for one or two brushed motors.

MSRP - \$12⁰⁰
MIKROE-4454



Brushless 8 Click

The TC78B042FTG, a sine-wave PWM drive three-phase full-wave brushless motor controller.

MSRP - \$29⁰⁰
MIKROE-4275



Brushless 9 Click

The TC78B027FTG, a 1-Hall sine-wave PWM controller for three-phase brushless DC motors.

MSRP - \$19⁰⁰
MIKROE-4387

AUDIO & VOICE



SpeakUp Click

A speech recognition Click. Can recognize over 200 different voice commands.

MSRP - \$39⁰⁰
MIKROE-1534



SpeakUp 2 Click

A speech recognition Click. Set it up to recognize up to 100 commands.

MSRP - \$34⁰⁰
MIKROE-2375



Audio Amp 4 Click

With the LM4860, an audio amplifier IC capable of delivering up to 1W of continuous power to an 8Ω load.

MSRP - \$17⁰⁰
MIKROE-3271



AudioMUX Click

Two-band digitally controlled high-quality audio processor with BASS ALC feat. and a 4-channel input selector.

MSRP - \$49⁰⁰
MIKROE-3344



Audio Amp 5 Click

The TPA3138D2, an inductorless stereo class-D audio amplifier, from Texas Instruments.

MSRP - \$17⁰⁰
MIKROE-3401



Audio Amp 6 Click

The TPA3138D2, a stereo class-D audio amplifier, from Texas Instruments.

MSRP - \$14⁰⁰
MIKROE-3448



MIC 2 Click

The MCP6022, a dual, rail-to-rail, low noise operational amplifier from Microchip.

MSRP - \$15⁰⁰
MIKROE-3445



Rec&Play Click

The ISD3900, a multi-message record and playback device with ChipCorder® technology, by Nuvoton.

MSRP - \$45⁰⁰
MIKROE-3345



2x20W Amp Click

Carries MAX9744 stereo class D audio power amplifier from Maxim Integrated.

MSRP - \$21⁰⁰
MIKROE-2779



2x5W AMP Click

Functions as an amplifier. With TDA7491LP 2x5-watt dual BTL class-D audio amplifier.

MSRP - \$19⁰⁰
MIKROE-2477





Audio Amp Click
A mono audio amplifier. With TI's LM48100Q-Q1 Boomer™ Mono, 1.3W Audio Power Amplifier IC.

MSRP - \$14⁰⁰
MIKROE-2368



BUZZ Click
Features a piezo speaker capable of emitting audio signals. Resonant frequency 3.8 kHz.

MSRP - \$9⁰⁰
MIKROE-945



BUZZ 2 Click
With CMT-8540S-SMT magnetic buzzer transducer. The buzzer's resonant frequency is 4 kHz.

MSRP - \$12⁰⁰
MIKROE-2720



StereoAmp Click
With 2 TI's LM48100Q-Q1 Boomer™ single supply, mono, bridge-tied load amplifier ICs.

MSRP - \$24⁰⁰
MIKROE-2454



TextToSpeech Click
With S1V30120 speech synthesis IC powered by the Fonix DECTalk® v5 speech synthesis engine.

MSRP - \$39⁰⁰
MIKROE-2253



Mic Click
With SPQ0410HR5H-B surface mount silicon microphone with max. RF protection.

MSRP - \$9⁰⁰
MIKROE-2563



MP3 Click
With a stereo MP3 decoder VS1053. Multiple formats (MP3, MP1, MP2, MPEG4, etc.).

MSRP - \$21⁰⁰
MIKROE-946



2x30W Amp Click
The TPA3128, 2x30-W class-D amplifier with low idle power dissipation, from TI.

MSRP - \$23⁰⁰
MIKROE-3010



Audio Amp 2 Click
The TDA7491, a 20W dual BTL class-D audio amplifier IC, from STMicroelectronics.

MSRP - \$21⁰⁰
MIKROE-3077



EVC Click
The PT2258, a six-channel electronic volume controller IC, by Princeton Technology Corp.

MSRP - \$17⁰⁰
MIKROE-3358



GainAMP 2 Click
A 6-channel programmable gain amplifier. Amplifies up to 32x, in eight discrete steps.

MSRP - \$15⁰⁰
MIKROE-2859



RadioStation Click
With the Si4713-B30, the best in class integrated FM broadcast stereo transmitter.

MSRP - \$25⁰⁰
MIKROE-2822



Noise Click
With noise detecting circuitry. Enables you to set a noise detection threshold.

MSRP - \$29⁰⁰
MIKROE-2371



FM Click
Features Si4703 IC and functions as a FM radio tuner. Supports worldwide FM band (76-108 MHz).

MSRP - \$29⁰⁰
MIKROE-1431



GainAMP Click
Carries LTC®6912 channel, low noise, digitally programmable gain amplifier (PGA).

MSRP - \$15⁰⁰
MIKROE-2555



AM/FM Click
Based on the Si4731 IC - digital CMOS AM/FM radio receiver from Silicon Labs.

MSRP - \$49⁰⁰
MIKROE-3800



Audio Amp 3 Click
Based on the Si4731 IC - digital CMOS AM/FM radio receiver from Silicon Labs.

MSRP - \$45⁰⁰
MIKROE-3901



Audio Xover Click
An analog active crossover solution for two-way loudspeakers with MCP6H012.

MSRP - \$18⁰⁰
MIKROE-4104



MIC 3 click
Features the SSM2167-1RMZ-R7, a Microphone Preamplifier.

MSRP - \$15⁰⁰
MIKROE-4136



MP3 2 Click
Based on KT403A, a hardware audio MP3/WAV decoder and DSP, with on-board microSD card slot.

MSRP - \$17⁰⁰
MIKROE-4159





DTMF Generator Click

Features the HT9200A, a dual-tone multi-frequency decoder.

MSRP - \$15⁰⁰
MIKROE-4298



BUZZ 3 Click

The PAM8904, a piezo-sounder driver with a Multi-Mode charge pump boost converter.

MSRP - \$9⁰⁰
MIKROE-4390



Volume Click

Based on the CS3310, a complete stereo digital volume control.

MSRP - \$43⁰⁰
MIKROE-4450



DSP Click

Based on the V1000, a complete multi-effects audio DSP from Coolaudio.

MSRP - \$45⁰⁰
MIKROE-4431



Volume 2 click

The NJU72341, a 2-channel I2C configurable electronic volume IC with external mute control.

MSRP - \$15⁰⁰
MIKROE-4560



DTMF Decoder Click

Features the MT8870D, a complete DTMF receiver integrating the band-split filter.

MSRP - \$16⁰⁰
MIKROE-4579

MIXED SIGNAL



PIXI™ Click

Features proprietary PIXI™ technology. Configurable 20-channel mixed-signal data converter.

MSRP - \$29⁰⁰
MIKROE-2817



Multimeter Click

Has different ICs: amplifiers, NE555 timer, BCD decoder, frequency to voltage converter, and an A/D converter [ADC].

MSRP - \$39⁰⁰
MIKROE-3116



LEM Click

Measures AC and DC current (up to 200 KHz). With LTS 6-NP current transducer.

MSRP - \$59⁰⁰
MIKROE-2553



PAC1934 Click

Carries PAC1934 four channel DC power/frequency monitor from Microchip.

MSRP - \$29⁰⁰
MIKROE-2735



V to Hz Click

The TC9400, a voltage-to-frequency and frequency-to-voltage converter from Microchip.

MSRP - \$27⁰⁰
MIKROE-2889



Hz to V Click

The TC9400, a voltage-to-frequency and frequency-to-voltage converter from Microchip.

MSRP - \$27⁰⁰
MIKROE-2890



PAC1921 Click

The PAC1921, a high side power/current monitor from Microchip.

MSRP - \$17⁰⁰
MIKROE-2910



DIGI POT 3 Click

The AD5321, a 1024-position (10bit) digital potentiometer with a non-volatile memory [EEMEM].

MSRP - \$21⁰⁰
MIKROE-3016



ADC 6 Click

With the AD7124-8, an 8 channel, low noise, low power, 24bit sigma-delta ADC.

MSRP - \$29⁰⁰
MIKROE-2932



ADC 7 Click

The LTC2500-32. It is a 32-bit oversampling ADC with a configurable digital filter, from Analog Devices.

MSRP - \$99⁰⁰
MIKROE-3115





AC Current Click
Measure alternating currents up to 30A. MCP3201 ADC converter and MCP607 CMOS Op Amp.

MSRP - \$14⁰⁰
MIKROE-2523



ADAC Click
It's an 8-channel 12-bit ADC, DAC and GPIO. With AD5593R configurable ADC/DAC.

MSRP - \$14⁰⁰
MIKROE-2523



ADC Click
With Microchip's MCP3204 12-bit Analog-to-Digital converter.

MSRP - \$26⁰⁰
MIKROE-2690



Hz to V 2 Click
With the VFC32KU, a voltage-to-frequency and frequency-to-voltage converter.

MSRP - \$42⁰⁰
MIKROE-3126



V to Hz 2 Click
With the VFC32KU, a voltage-to-frequency and frequency-to-voltage converter.

MSRP - \$42⁰⁰
MIKROE-3131



DAC 3 Click
Carries Microchip's MCP4726 IC, a 12-bit digital-to-analog converter.

MSRP - \$18⁰⁰
MIKROE-2038



ADC 2 Click
With MCP3551/3, a 22-bit ADC with automatic internal offset and gain calibration.

MSRP - \$24⁰⁰
MIKROE-1893



ADC 3 Click
With Microchip's MCP3428 16-bit multichannel analog-to-digital converter.

MSRP - \$22⁰⁰
MIKROE-1894



ADC 4 Click
An advanced analog to digital multichannel converter. It can work in 16bit or 24bit mode.

MSRP - \$65⁰⁰
MIKROE-2879



ADC 5 Click
With a low power, single channel 12-bit CMOS analog to digital converter.

MSRP - \$18⁰⁰
MIKROE-2846



Ammeter Click
With circuitry for measuring electric current (AC and DC). 0.1A-1A measurement range.

MSRP - \$24⁰⁰
MIKROE-2377



C Meter Click
Circuitry for measuring the value of capacitors. Based on NE-555 timer/ square-wave generator.

MSRP - \$9⁰⁰
MIKROE-2376



Comparator Click
Carries LM2903 IC, has two independent precision voltage comparators. 2 mV offset voltage.

MSRP - \$12⁰⁰
MIKROE-1915



DAC Click
Includes a 12-bit Digital-to-Analog Converter MCP4921 from Microchip.

MSRP - \$18⁰⁰
MIKROE-950



DAC 2 Click
Carries LTC2601CDD, a 16-bit digital-to-analog converter from Linear Technology.

MSRP - \$19⁰⁰
MIKROE-1918



DIGI POT Click
Carries MCP416 single-channel 8-bit resolution [256 wiper steps] digital potentiometer.

MSRP - \$16⁰⁰
MIKROE-923



DIGI POT 2 Click
Carries a single channel digital potentiometer TPL0501 with 256 wiper positions.

MSRP - \$16⁰⁰
MIKROE-2332



DIGI POT 4 Click
A digitally controlled dual potentiometer, with the resistance of 10KΩ.

MSRP - \$21⁰⁰
MIKROE-2873



R Meter Click
With circuitry for measuring the value of resistors. A wide range of resistors [0-1 Mega Ohm].

MSRP - \$27⁰⁰
MIKROE-2396



Voltmeter Click
For measuring voltage in an external electric circuit. Measures direct current [from 0 to 24V].

MSRP - \$24⁰⁰
MIKROE-2436





DIGI POT 5 Click
A digitally controlled quad potentiometer, with the resistance of 10KΩ.

MSRP – \$16⁰⁰
MIKROE-2863



PWR Meter Click
Uses the MCP39F511A, a very sophisticated monitoring IC from Microchip, with 16-bit processing core.

MSRP – \$42⁰⁰
MIKROE-3169



PWR Meter 2 Click
Measuring and monitoring voltage up to 24V and current up to 5A. It carries the MCP3910 module.

MSRP – \$19⁰⁰
MIKROE-3150



RMS to DC Click
With the LTC1968, converter IC, which outputs an analog voltage depending on the RMS value of the input signal.

MSRP – \$35⁰⁰
MIKROE-3311

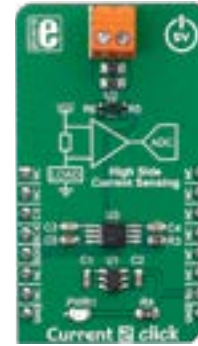

Current 2 Click
Equipped with an integrated transimpedance amplifying circuit.

MSRP – \$17⁰⁰
MIKROE-3292



DAC 7 Click
It's an advanced 12-bit, four-channel digital to analog converter [DAC] with AD5624R.

MSRP – \$26⁰⁰
MIKROE-3886



DAC 8 Click
The DAC8554IPWR, a 16-bit QUAD channel voltage-output digital to analog converter.

MSRP – \$35⁰⁰
MIKROE-4229



DigiVref Click
With the MCP1541 it is a perfect solution to be used in various A/D conversion applications.

MSRP – \$15⁰⁰
MIKROE-3334



Waveform Click
The AD9833, a low-power, programmable waveform generator.

MSRP – \$47⁰⁰
MIKROE-3309



Waveform 2 Click
Features the AD9834, a 75 MHz low power DDS device.

MSRP – \$45⁰⁰
MIKROE-4346

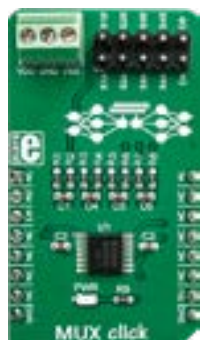

MUX Click
Equipped with the MUX509, a precise analog multiplexing IC.

MSRP – \$17⁰⁰
MIKROE-3247



MUX 2 Click
The MUX508, a modern CMOS analog multiplexing integrated circuit.

MSRP – \$17⁰⁰
MIKROE-3245



MUX 3 Click
Based around the TMUX1208 module, a 5-V Bidirectional 8:1, 1-Channel Multiplexer.

MSRP – \$7⁰⁰
MIKROE-3916



DAC 4 Click
The MCP4728, a quad, 12-bit voltage output Digital-to-Analog Converter [DAC] with [EEPROM].

MSRP – \$12⁰⁰
MIKROE-3707



DAC 5 Click
It's an advanced 10-bit eight-channel digital to analog converter [DAC] with DAC53608.

MSRP – \$15⁰⁰
MIKROE-3712



L meter click
Features the LM311D, a high-speed voltage comparator.

MSRP – \$9⁰⁰
MIKROE-3505



AD-SWIO Click
The AD74412R a quad-channel software configurable input/output solution.

MSRP – \$49⁰⁰
MIKROE-4081



AD-SWIO 2 Click
With a 16-bit ADC converter, and 13-bit DAC converter integrated into the AD74413R.

MSRP – \$56⁰⁰
MIKROE-3861



AN To PWM click
Uses OPA365 series op-amps, and the TLV3201 comparators from TI.

MSRP – \$12⁰⁰
MIKROE-4060



AN to PWM 2 Click
Features the LTC6992CS6, a silicon oscillator from Analog Devices.

MSRP – \$24⁰⁰
MIKROE-4221





ISO ADC Click

The AMC1204BDWR, Isolated Delta-Sigma Modulator for Current-Shunt Measurement.

MSRP - \$15⁰⁰
MIKROE-4088



ISO ADC 2 Click

Features the AD7091R, successive-approximation analog-to-digital converter [ADC].

MSRP - \$45⁰⁰
MIKROE-4166



ISO ADC 3 Click

Features the AMC1100, a precision isolation amplifier.

MSRP - \$15⁰⁰
MIKROE-4383



ADC 8 Click

The ADS1115 a high precision, low-power, 16-bit analog-to-digital converter [ADC].

MSRP - \$21⁰⁰
MIKROE-3394



ADC 9 Click

Based on MCP3564 a 24-bit Delta-Sigma Analog-to-Digital Converter.

MSRP - \$17⁰⁰
MIKROE-4105



Wheatstone Click

With the MAX4208 - an ultra-low offset/drift, precision instrumentation amplifier.

MSRP - \$15⁰⁰
MIKROE-4124



DAC 6 Click

The DAC104S085, 10-bit, micro-power, a quad digital-to-analog converter.

MSRP - \$15⁰⁰
MIKROE-4206



DAC 9 Click

Features the DAC80501, a 16-bit voltage-output digital-to-analog converter.

MSRP - \$15⁰⁰
MIKROE-4332



DIGI POT 7 Click

Features the AD5175, a single-channel 1024-position digital rheostat.

MSRP - \$12⁰⁰
MIKROE-4414



Current 3 Click

Features the EMC1702, a combination of the high-side current sensing device.

MSRP - \$15⁰⁰
MIKROE-4203



ADC 10 Click

Features the AD-S122U04, a 24-bit precision $\Sigma\Delta$ ADC converter.

MSRP - \$27⁰⁰
MIKROE-4488



ADC 12 Click

The ADS7828, a low-power 12-bit data acquisition device.

MSRP - \$27⁰⁰
MIKROE-4376



DIGI POT 6 Click

Features the MCP41HV51, 8-bit dual power rails digital potentiometer.

MSRP - \$14⁰⁰
MIKROE-4110



VCP monitor 2 Click

Uses the INA3221-Q1, a three-channel, high-side current and bus voltage monitor.

MSRP - \$23⁰⁰
MIKROE-4126



VCP Monitor 3 Click

Features the LTC2947 a high precision power and energy monitor.

MSRP - \$27⁰⁰
MIKROE-4222



Analog MUX 2 Click

Features the ADG728, a low voltage, CMOS 8-channel analog matrix switch.

MSRP - \$18⁰⁰
MIKROE-4468



Waveform 3 Click

Uses the AD9837, a fully integrated direct digital synthesis [DDS] device.

MSRP - \$25⁰⁰
MIKROE-4432



DAQ 3 Click

Uses the ADAQ4003, a fast and precise system-in-package DAQ signal chain solution.

MSRP - \$79⁰⁰
MIKROE-4486



Analog MUX 3 Click

Uses the ADG738, a CMOS analog matrix switch with a serially-controlled SPI interface.

MSRP - \$12⁰⁰
MIKROE-4580



POWER MANAGEMENT



BATT-MAN Click

The LTC3586, a high-efficiency power manager with boost, buck-boost, and dual buck converters.

MSRP – \$27⁰⁰
MIKROE-2901



MCP73213 Click

Carries MCP73213 dual-cell Li-Ion/Li-Polymer battery charge management controller.

MSRP – \$18⁰⁰
MIKROE-2575



MIC23099 Click

Carries MIC23099 single AA/AAA cell step-down/step-up regulator with battery monitoring.

MSRP – \$29⁰⁰
MIKROE-2765



MIC24045 Click

Carries MIC24045 5A synchronous step-down regulator. Input range 4.5V-19V.

MSRP – \$13⁰⁰
MIKROE-2574



VREG Click

Digitally controlled DC voltage regulator. Based on the well-known LM317 circuit.

MSRP – \$24⁰⁰
MIKROE-2443



Charger 2 Click

The STBC08, an 800 mA standalone linear Li-Ion battery charger with thermal regulation.

MSRP – \$17⁰⁰
MIKROE-3049



MCP16331 INV Click

Works in an inverting configuration, provides a negative output voltage in respect to the GND.

MSRP – \$22⁰⁰
MIKROE-2917



Step Down 2 Click

The L6986HTR is a step-down monolithic switching regulator able to deliver up to 2 A DC.

MSRP – \$15⁰⁰
MIKROE-3895



Step Up Click

The MCP1665, a 500 kHz, compact, high-efficiency, fixed-frequency, nonsynchronous step-up DC-DC.

MSRP – \$19⁰⁰
MIKROE-3709



Peltier Click

With the SPV1050, an ultralow power energy harvester and battery charger.

MSRP – \$15⁰⁰
MIKROE-3814





MIC24055 Click
Equipped with the MIC24055, high-efficiency buck regulator from Microchip.

MSRP - \$29⁰⁰
MIKROE-2835



Qi Receiver Click
Utilizes the principles of the inductive coupling for the purpose of wireless power transfer.

MSRP - \$18⁰⁰
MIKROE-2799



Solar energy Click
Uses TI's BQ25570 - a nano-power high-efficiency boost charger and buck converter device.

MSRP - \$27⁰⁰
MIKROE-2814



MIC33153 Click
A DC-DC adjustable step-down (buck) converter.

MSRP - \$21⁰⁰
MIKROE-2887



VREG 2 Click
Uses the LM2596, a 3A, step down voltage regulator working at 150 kHz, from Texas Instruments.

MSRP - \$21⁰⁰
MIKROE-3055



Boost Click
Carries Microchip's MIC2606, a 2MHz, PWM DC/DC boost switching regulator.

MSRP - \$21⁰⁰
MIKROE-2780



BOOST 2 Click
A DC-DC step-up regulator that has a fixed 5V output.

MSRP - \$15⁰⁰
MIKROE-2894



Boost 4 Click
Carries TI's TPS61230A, a high efficiency fully integrated synchronous boost converter.

MSRP - \$17⁰⁰
MIKROE-2757



Nano Power 2 Click
The MAX40000AUT12+, a nanoPower comparator with built-in reference.

MSRP - \$11⁰⁰
MIKROE-3036



Smart Buck Click
The MIC2230, a dual synchronous step-down DC/DC regulator.

MSRP - \$29⁰⁰
MIKROE-3113



Buck-Boost 2 Click
The LTC3115-2, a 40V, 2A synchronous buck-boost DC/DC converter from Linear Technology.

MSRP - \$27⁰⁰
MIKROE-2963



Buck-Boost Click
Features LTC3129-1, a buck-boost DC/DC conversion integrated circuit.

MSRP - \$20⁰⁰
MIKROE-2606

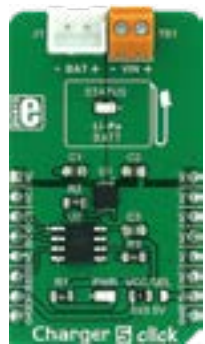

Charger 5 Click
Designed to charge Lithium-Ion and Lithium-Polymer batteries.

MSRP - \$16⁰⁰
MIKROE-2848



MCP16331 Click
Functions as a non-inverting buck-boost voltage regulator.

MSRP - \$22⁰⁰
MIKROE-2762

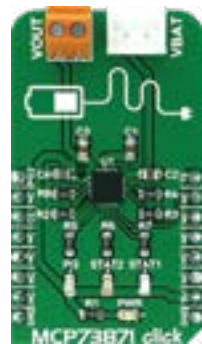

MCP73871 Click
Integrated solution for system power delivery and Li-Po/Li-Ion battery charge management.

MSRP - \$16⁰⁰
MIKROE-2658



BUCK 7 Click
The MAX17504, a high efficiency, synchronous step-down DC-DC converter with internal compensation.

MSRP - \$27⁰⁰
MIKROE-3094



Buck 8 Click
Uses the MAX17536, a high-efficiency, synchronous step-down DC-DC converter.

MSRP - \$26⁰⁰
MIKROE-2997



Buck-Boost 3 Click
The ISL85403, a 2.5A regulator with the integrated high-side MOSFET and a low-side driver.

MSRP - \$27⁰⁰
MIKROE-3277



Charger Click
Carries a battery charger controller and a battery charge monitor, along with a battery connector.

MSRP - \$22⁰⁰
MIKROE-2033



Charger 8 Click
The MAX8903B and the MAX17201, both ICs from Maxim Integrated.

MSRP - \$24⁰⁰
MIKROE-3348

**Buck 9 Click**

The MP9943, a synchronous step-down converter, from Monolithic Power Systems [MPS].

MSRP - \$21⁰⁰
MIKROE-3057

**Buck 10 Click**

The MPM3632C, a 18V 3A ultra-low profile DC-to-DC power module by Monolithic Power Systems [MPS].

MSRP - \$15⁰⁰
MIKROE-3569

**Buck 11 Click**

The LMR36015, a synchronous step-down converter, from Texas Instruments.

MSRP - \$21⁰⁰
MIKROE-3438

**Buck 12 Click**

The MPQ8632, a synchronous step-down converter, from Monolithic Power [MPS].

MSRP - \$21⁰⁰
MIKROE-3438

**Buck 13 Click**

The MPM3530, a 55V 3A ultra-low profile DC-to-DC power module by Monolithic Power Systems [MPS].

MSRP - \$21⁰⁰
MIKROE-3438

**BUCK 5 Click**

The MAX17506, a high efficiency, synchronous step-down DC/DC converter with internal compensation.

MSRP - \$29⁰⁰
MIKROE-3100

**BUCK 6 Click**

Uses the MAX17572, a step down [buck] DC-DC converter from Maxim Integrated.

MSRP - \$18⁰⁰
MIKROE-2957

**Boost-INV Click**

The LTC3582, programmable boost and inverting DC/DC converter with OTP memory.

MSRP - \$21⁰⁰
MIKROE-3124

**Boost-INV 2 Click**

The TPS65131, a positive and negative output DC/DC Converter, from Texas Instruments.

MSRP - \$29⁰⁰
MIKROE-3123

**UPS Click**

The LTC3225, a 150mA supercapacitor charger from Analog Devices.

MSRP - \$25⁰⁰
MIKROE-3001

**Charger 9 Click**

The MAX1757, a stand-alone, switch-mode Li+ battery charger, from Maxim Integrated.

MSRP - \$24⁰⁰
MIKROE-3568

**BUCK Click**

Buck switching regulator. A wide input voltage range of up to 40V. Steps it down to 3.3V or 5V.

MSRP - \$28⁰⁰
MIKROE-1592

**Buck 2 Click**

A powerful step down DC-DC switching regulator. Input voltage range 4.5V-19V.

MSRP - \$16⁰⁰
MIKROE-2858

**Buck 3 Click**

Uses the TPS568215, a 4.5V to 17V Input, 8A synchronous step-down SWIFT™ converter.

MSRP - \$22⁰⁰
MIKROE-2971

**Boost 6 Click**

The BQ25887 fully integrated 2-cell Li-ion batt. charger IC ideal for portable app. with cell balancing.

MSRP - \$15⁰⁰
MIKROE-3813

**Nano Power Click**

The MAX17222 - a nanoPower synchronous boost converter with True Shutdown™ technology.

MSRP - \$11⁰⁰
MIKROE-3035

**Balancer 3 Click**

The BQ29200, Voltage Protection with Automatic Cell Balance for 2-Series Cell Li-Ion Batt.

MSRP - \$12⁰⁰
MIKROE-3737

**Balancer 5 Click**

The BQ25887 fully integrated 2-cell Li-ion batt. charger IC ideal for portable app. with cell balancing.

MSRP - \$15⁰⁰
MIKROE-3853

**BATT-MON Click**

The STC3115, a high-precision batt. gas gauge IC with alarm output for handheld app.

MSRP - \$13⁰⁰
MIKROE-3741

**BUCK 14 Click**

Based around the BMR4613001/001 - a PoL regulator from Flex.

MSRP - \$32⁰⁰
MIKROE-3847





Charger 11 Click

The MCP73123 - Lithium Iron Phosphate (LiFePO4) batt. charger management controller.

MSRP - \$17⁰⁰
MIKROE-3650



Charger 12 Click

The MAX1501 - linear battery charger with thermal regulation for portable applications.

MSRP - \$15⁰⁰
MIKROE-3744

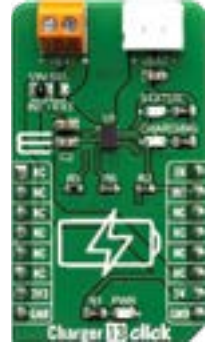

Charger 13 Click

It's a single lithium-ion (Li+) cell batt. charger based on the RT-9532GQW.

MSRP - \$15⁰⁰
MIKROE-3748



Single Cell Click

The MCP16251 synchronous boost reg. with true load disconnect and MCP1811A LDO linear reg.

MSRP - \$9⁰⁰
MIKROE-3844



3xBuck Click

It relies on the TPS65263, a triple synchronous step-down converter.

MSRP - \$35⁰⁰
MIKROE-3201



Boost 3 Click

The TPS61391, a 700-kHz pulse-width modulating (PWM) Step-Up converter.

MSRP - \$15⁰⁰
MIKROE-4287



USB-C Source Click

The STUSB4700, an independent USB power delivery controller.

MSRP - \$25⁰⁰
MIKROE-4329



USB-C Sink Click

Features the STUSB4700, an independent USB power delivery controller.

MSRP - \$25⁰⁰
MIKROE-4328



Buck & Boost Click

The MIC7401, a highly-integrated power-management IC with five synchronous buck regulators.

MSRP - \$69⁰⁰
MIKROE-4354



eFuse 2 Click

The TPS259631, a highly integrated circuit protection and power management solution.

MSRP - \$21⁰⁰
MIKROE-4335



Balancer 2 click

The MCP3202, Dual Channel 12-Bit A/D Converter with SPI Serial Interface.

MSRP - \$15⁰⁰
MIKROE-4058



PowerBank Click

Uses MP2632B a highly integrated 3A Lu-ion and Li-polymer battery charger.

MSRP - \$19⁰⁰
MIKROE-4082



PowerBank 2 Click

Equipped with the RT9480, highly integrated and easy to use power solution.

MSRP - \$19⁰⁰
MIKROE-4116



Power MUX Click

Uses the TPS2115AP-WR IC, auto-switching power multiplexer.

MSRP - \$11⁰⁰
MIKROE-4109

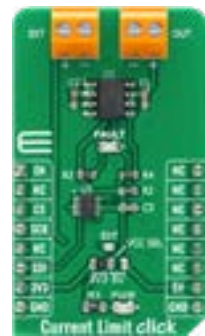

Current Limit Click

Features the MAX890L, a low-resistance power switch.

MSRP - \$15⁰⁰
MIKROE-4271



Qi RX Click

The PIC16F15313, a 8-bit MCU that makes a flexible, alternative to the wireless charging solutions.

MSRP - \$33⁰⁰
MIKROE-4345



Charger 3 Click

Features the TP4056, a complete constant-current/constant-voltage linear charger.

MSRP - \$12⁰⁰
MIKROE-4449



UPS 3 Click

The LTC3110, a bidirectional buck-boost DC/DC regulator/charger combination.

MSRP - \$29⁰⁰
MIKROE-4479

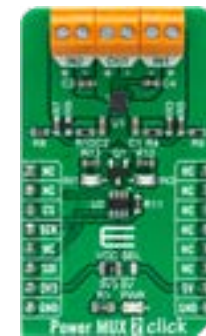

Power MUX 2 Click

The TPS2120, a dual-input single-output power multiplexer with an automatic switchover.

MSRP - \$15⁰⁰
MIKROE-4575



Charger 6 Click

Uses the BQ25601, a fast-charging solution for single-cell Li-ion and Li-polymer battery.

MSRP - \$12⁰⁰
MIKROE-4576



CLOCK & TIMING



RTC 4 Click

Carries DS2417, a real time clock/calendar with a 1-Wire MicroLAN interface. 16.3 kbits per second.

MSRP - \$21⁰⁰
MIKROE-1891



RTC 5 Click

Carries Microchip's MCP79510 real-time clock/calendar.

MSRP - \$21⁰⁰
MIKROE-1990



PLL Click

The ICS501, a LOCO™ PLL clock multiplier, from Integrated Device Technology.

MSRP - \$15⁰⁰
MIKROE-2993



Clock Gen 2 Click

The DS1087LU-266, a 3.3V spread-spectrum EconOscillator, from Maxim Integrated.

MSRP - \$17⁰⁰
MIKROE-3076



RTC 8 Click

The RV-3028-C7, an extreme low power RTC module from Micro Crystal Switzerland.

MSRP - \$17⁰⁰
MIKROE-3076



RTC 6 Click

Carries MCP79410 real-time clock/calendar IC. 64 bytes of battery-backed SRAM.

MSRP - \$21⁰⁰
MIKROE-2063



TIMER Click

With DS1682 total elapsed time recorder from Maxim Integrated. ETC used with the ALARM pin.

MSRP - \$18⁰⁰
MIKROE-2333



PULSE Click

A pulse generator with precise frequency control. Features NE555 precision timer.

MSRP - \$25⁰⁰
MIKROE-2032



RTC 2 Click

With DS1307 serial real-time clock. It's a full binary-coded decimal [BCD] clock/calendar.

MSRP - \$21⁰⁰
MIKROE-948



RTC 3 Click

Carries BQ32000, a real time clock with an integrated trickle charge circuit for automatic switchover.

MSRP - \$21⁰⁰
MIKROE-1839





One Shot Click

The LTC6993-2, a monostable multivibrator known as a "one-shot" pulse generator.

MSRP - \$19⁰⁰
MIKROE-3877



RTC 7 Click

The MAX31341B, a low-current RTC with I2C interface and power management.

MSRP - \$17⁰⁰
MIKROE-2976



RTC 10 Click

The DS3231M, a low-cost, extremely accurate, I2C real-time clock (RTC).

MSRP - \$17⁰⁰
MIKROE-2976



Clock Gen Click

Features the Si5351A, an I2C configurable clock generator.

MSRP - \$15⁰⁰
MIKROE-4113

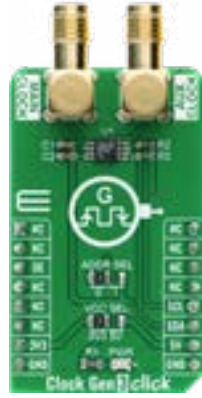

Clock Gen 3 Click

Uses the LTC6904 IC, 1kHz to 68MHz Serial Port Programmable Oscillator.

MSRP - \$17⁰⁰
MIKROE-4171



RTC Click

It features the PCF8583 serial real-time clock (RTC).

MSRP - \$21⁰⁰
MIKROE-947



Clock Gen 4 Click

The CS2200-CP, an analog PLL architecture comprised of a Delta-Sigma fractional-N frequency synthesizer.

MSRP - \$19⁰⁰
MIKROE-4300



Clock Gen 5 Click

Features the LTC6903, a low-power self-contained digital frequency source.

MSRP - \$15⁰⁰
MIKROE-4413



RTC 9 Click

Features the M41T82, real-time clock (RTC) with battery switchover

MSRP - \$12⁰⁰
MIKROE-4121

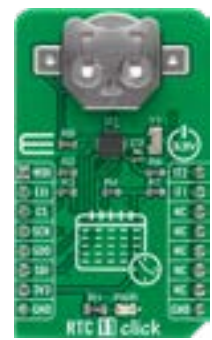

RTC 11 Click

The AB0815, an ultra-low-power coupled with a highly sophisticated feature set.

MSRP - \$7⁰⁰
MIKROE-4288



Watchdog Click

Features the TPS3430, a stand-alone watchdog timer.

MSRP - \$7⁰⁰
MIKROE-4416





Everything under one roof

We are most fortunate to have our in-house production, procurement, and distribution - all of this enables us to push forward.

Every day we introduce a new Click board™, but at the same time, we produce at least 40-50 different Click boards™ to refill our warehouse or our distributor's warehouse. It is a most dynamic process: work is being constantly done inside the company, only to be completed at the end of the day when a courier comes in, picks up the boxes, and ships them.

8.250.291.250.200

This is the number of unique combinations you can make on a development board with 5 mikroBUS™ sockets and 1000 Click boards™, keep in mind that this number grows every day as we make one new product per day.

Most people do not understand how huge a trillion is.

Let us give you a hint: a million seconds is equal to 12 days; billion seconds is 31 years; and trillion seconds is 31688 years.

So if we spent a mere second on every combination of Click boards™ on a development board with five mikroBUS™ sockets, it would take well over 261615 years to test all of the combinations.

We are sure everyone will be able to find a great combination of Click boards™ for his or her new project. But just imagine the extra time that engineers world wide have thanks to this fast prototyping.

You can now test not one, but many project possibilities in virtually no time.

mikroBUS™ standard

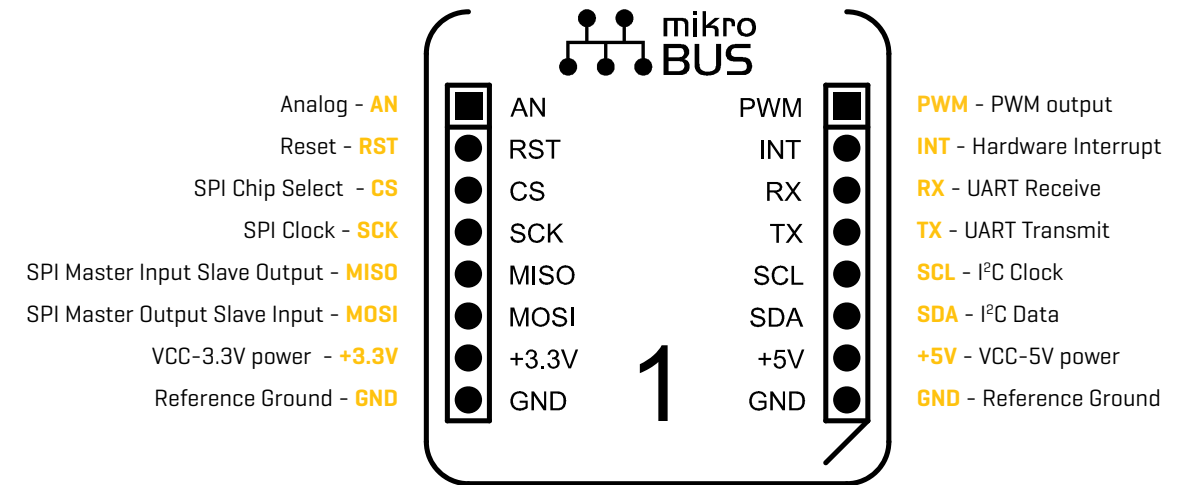

mikroBUS™ - the add-on board socket standard that offers maximum expandability with the smallest number of pins. All the major vendors have accepted the mikroBUS™ standard and added it to their development boards.



Growing with our partners

 7 Boards	 7 Boards	 6 Boards	 6 Boards
 6 Boards	 5 Boards	 5 Boards	 4 Boards
 4 Boards	 4 Boards	 4 Boards	 4 Boards
 4 Boards	 4 Boards	 4 Boards	 3 Boards
 3 Boards	 3 Boards	 3 Boards	 3 Boards
 3 Boards	 2 Boards	 2 Boards	 2 Boards
 2 Boards	 2 Boards	 2 Boards	 2 Boards
 2 Boards	 1 Boards	 1 Boards	 1 Boards

 159 Boards	 132 Boards	 57 Boards	 63 Boards
 25 Boards	 61 Boards	 5 Boards	 20 Boards
 22 Boards	 17 Boards	 19 Boards	 19 Boards
 14 Boards	 15 Boards	 15 Boards	 15 Boards
 13 Boards	 12 Boards	 11 Boards	 11 Boards
 11 Boards	 10 Boards	 9 Boards	 9 Boards
 9 Boards	 7 Boards	 8 Boards	 8 Boards

Clicking on all platforms

Use Click boards™ with your favorite development platform.
A range of Shields bring Click connectivity to:

- **Arduino**
- **BeagleBone Black**
- **Raspberry Pi**
- **Freedom**
- **Feather**
- **Discovery and more...**

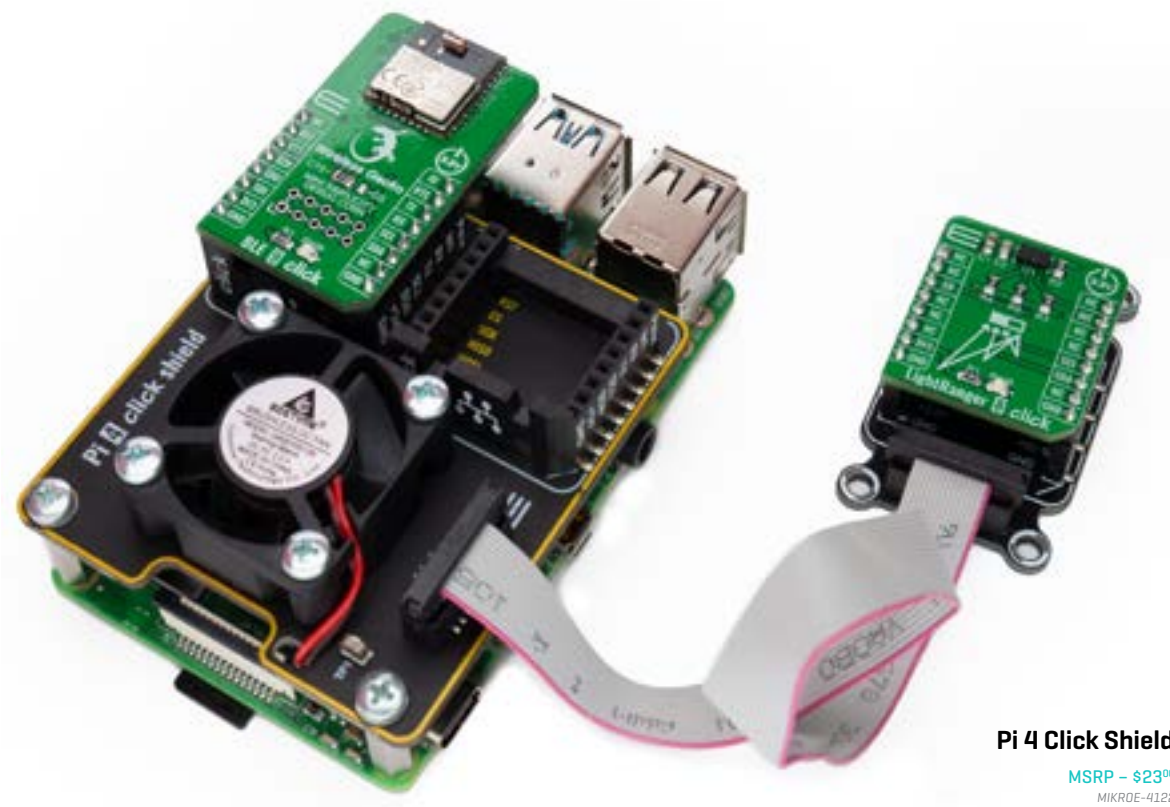

Pi 4 Click Shield
MSRP - \$23⁰⁰
MIKROE-4122



Arduino Nano Click Shield
MSRP - \$29⁰⁰
MIKROE-4443



Scan QR Code
to see them all.



mikroBUS cape
MSRP - \$8⁰⁰
MIKROE-1857



NEW
Click board™
yet to come

NEW
Click board™
yet to come

Even though it was printed recently, the booklet you are holding is probably already outdated. That's because we release new Click boards™ daily. To learn more about Click boards™, visit: www.mikroe.com/click-boards and for the most current list of Click boards™, visit: www.mikroe.com/click

NEW
Click board™
yet to come

NEW
Click board™
yet to come

MIKROE



Aleksandar Mitrovic

Click boards™
PRODUCT MARKETING MANAGER

Aleksandar is in charge of our Click board™ product line. He started his career at Mikro through internship and later technical support, making his way up to his current position.

This accomplishment requested huge dedication to the work, to the customers and products, all of which he demonstrated during the years of employment at Mikro. As someone who is taking care of hundreds existing and countless future Click boards™, he will be your main contact regardless if you are silicon vendor interested in **Chips4Clicks program** or a regular customer interested in sharing ideas about a new Click board™.



Scan QR
Code for
contact info.

