

1. Product overview

Dual power automatic switch is a newly developed micro household power switch. The switch is mainly used to test whether the main power supply or standby power is normal. When the normal power supply is abnormal, the standby power supply will immediately start to work, to ensure the continuity, reliability and safety of the power supply. This product is specially designed for domestic track installation and is specially used for PZ30 distribution box.

Dual power automatic switch is suitable for 50 or 60Hz rated 400V AC emergency power supply system. ATS has the characteristics of solid structure, reliable conversion, easy installation and maintenance and long life. It is widely used in a variety of occasions when can not sustain power failure, that is, reliable electrical work, but also manual operation. ATS is made up of TSE and controller.

According to GB/T14048.11, makes part 6-1: multi-function equipment and switching equipment, ATS is the most suitable low-voltage switching equipment and control device.

2. Product model and classification

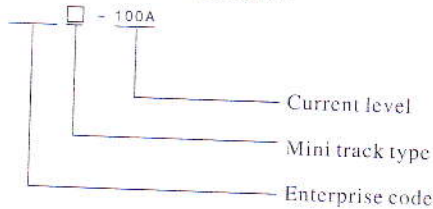

4. Normal operation time and installation conditions

4.1 Ambient air temperature

The highest temperature shall not exceed 40°C, the lowest shall not be lower than -5°C, and the average temperature within 24h shall not be higher than 35°C.

4.2 Altitude

The elevation of the installation site shall not be higher than 2000m.

4.3 Atmospheric conditions

When the highest temperature reaches 40°C, the relative humidity of the installation site shall not exceed 50%, when the lowest temperature is -5°C, the relative humidity is high, for example, the temperature is 25°C, while the relative humidity is 90%. Due to temperature changes, special measures should be taken to deal with the occasional condensation on the surface of the product.

4.4 Pollution levels

ATS pollution level conforms to the specified level 3 of GB/T14046.11

4.5 Installation category

ATS is installed in accordance with the category specified in GB/T14048.11

4.6 Installation conditions

The ATS can be installed vertically in the control cabinet or distribution cabinet. Make sure the installation distance is as shown in figure 1

5. View dimensions and mounting dimensions

5.1 The appearance and installation dimensions of ATS are shown in table 2 and figure 1.

6. Notes

6.1 Manual/Automatic operation

The ATS can guarantee power generation and power outage performance during circuit operation, but for manual operation, due to the difference in power generation and power outage speed or operator, the ATS cannot guarantee such performance. Excessive loss of silver alloys may occur during manual power generation and power outages. Therefore, when all the power is turned off to check and maintain the operating system and contacts, simply reverse the selection switch to the manual position. In general, the selection switch will be pulled to the automatic position.

After the manual operation is completed, pull the selection switch from the manual position to the automatic position.

6.2 control circuit
ATS will active instantly. After conversion, the line diagram in the control circuit will be disconnected by the internal converter. Under the

3. Basic parameters

Please refer to table 1 for details about basic ATS parameters

Table 1

Model	ATS-63A			ATS-100A	
Rated current Ie/A	16	20	25	32	40 50 63
Insulation voltage Ui	AC690V,50HZ				
Rated voltage Ue	AG400V,50Hz				
level	PC can be manufactured and sustained, without short				
Using categories	AC-33kB			AC-31B	
Rod	2P		3P		4P
Weight (kg)	1.7		2.1		2.6
Electrical appliances	life: 2000times; manual operation: 5000times				
Rated short charge	50kA				
Short circuit	RT16-00-63A				
The cap withstands	8kV				
Control circuit	Rated control voltage Us:AC220V,			85%Us-110%Us	
Auxiliary circuit	Two relays, each with two sets of contact capacity for the contact converter:AC220V50HZ Ie-5y				
Contactor conversion	<50ms				
Operation	<50ms				
Return conversion	<50ms				
Power off time	<50ms				

rated voltage of E80%-110%, the coil can operate normally. If the voltage is too low, the coil will become hot and even spontaneously ignite.

7. Wiring diagram (see figure 2, figure3)

8. Installation and wiring

8.1 Ensure that professionals read this manual before installing and wiring.

8.2 Check the integrity of the ATS before installation. Then use the operating handle to open and close APS, check the flexibility of the transmission device, and detect the generation and disconnection conditions of load in each stage of normal and standby power supply.

The correct steps are shown in the diagram. The trademark is on the front of the product. Please contact us if you fail to follow the correct steps due to wiring or other reasons. The safe distance S1 and S2 should be no less than the markings in figure 1 and figure 2 (See the picture below for details) Picture 4 Correct installation instructions.

8.4 Test control voltage: 50Hz, AC220V.

The coil should not be too long in the control circuit. The cutting surface area of copper wire should not be greater than 2.0mm.

8.5 According to the installation requirements of the power distribution system, please provide appropriate circuit breakers to ensure the safety of the staff and equipment.

9. Maintenance, inspection and storage

9.1 Maintenance and inspection should be carried out by professional personnel and all power should be cut off in advance.

9.2 To ensure good performance of the ATS, the first maintenance and inspection should be carried out within 6 months of use and at least once a year. In the case of severe installation conditions, increase the frequency of maintenance and inspection.

9.3 Renewal and inspection projects

- Please remove dust and dirt in case of failure.
- Inspect electrical contacts for variations and damage, and slip out any metal particles attached to or around the surface.
- Rust, acidification and dust on the contact surface may lead to poor contact. Please operate manually several times and measure the contact resistance when necessary.
- Before using, please remove dust and dirt of ATS, due to damp and suspended condition. Use a 500V megohm meter to measure the rejection resistance for normal supply, alternating power supply, load side bars, including insulation resistance between live parts and metal plates. And the insulation resistance should be no less than 10MΩ.

9.4 ATS shall be stored in an environment comparable to the normal working environment and shall be protected from dust, moisture and knock.

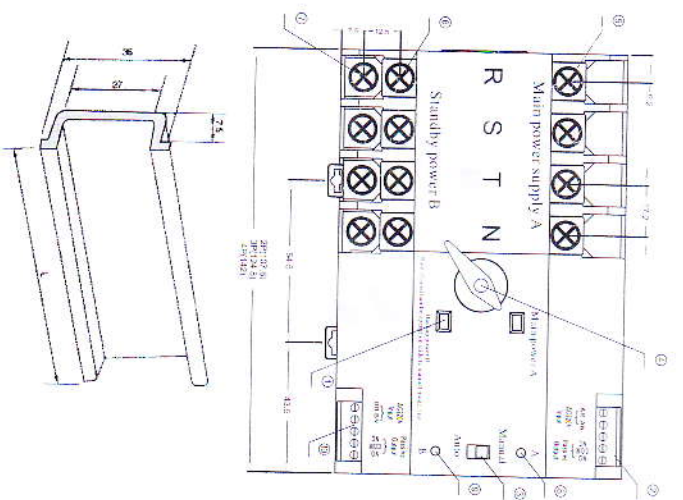

Picture 1 Appearance dimensions and Installation dimensions

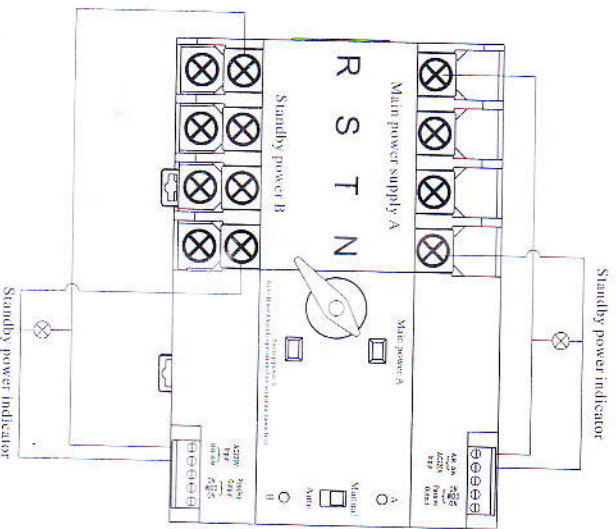

Picture 3 Controller wiring diagram

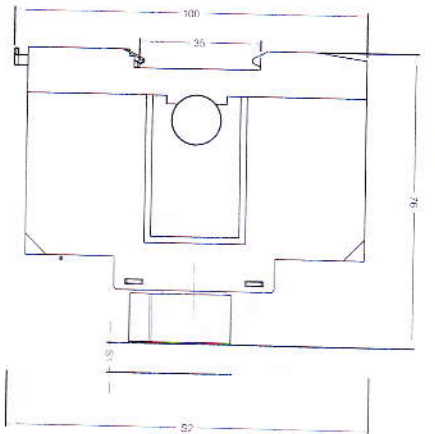

- 1. Status position indicator
 - 2. Main power terminal and passive signal (AC220V)
 - 3. Manual/Automatic switch
 - 4. Manual handle
 - 5. Common power supply side main terminal
 - 6. Backup power side main terminal
 - 7. Main terminal on load side
 - 8. A Power indicator
 - 9. B Power indicator
 - 10. Standby power terminal and passive signal (AC220V)
- Safe distance: S1 >= 30mm
S2 >= 203mm

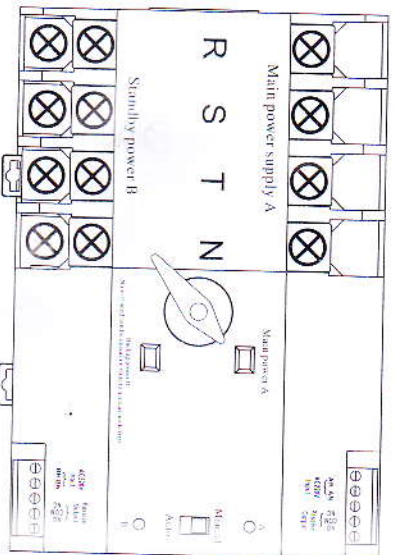

Picture 4 Correct mounting direction

Picture 2 Internal wiring diagram

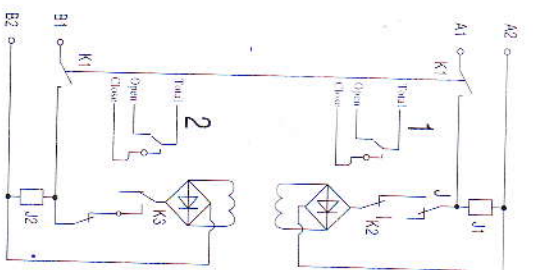
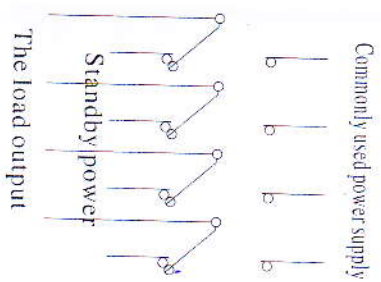

- K1 Manual/automatic selection switch
- K2 K/A Internal valve switch
- J1 Commonly used 220V A power supply relay
- J2 Standby 220V A power supply relay
- 1-: A power supply passive signal output
- 2-: B power supply passive signal output