



查询AU6254供应商

ALCOR Alcor Micro Corp.

捷多邦, 专业PCB打样工厂, 24小时加急出货

[Http://www.alcormicro.com/](http://www.alcormicro.com/)

Data Book

AU6254

USB2.0 Hub Controller

Technical Reference Manual

Product Specification

Official Release

Revision 1.00W

Public

Sep 2006





Data book status

Objective specification	This data book contains target specifications for product development.
Preliminary specification	This data book contains preliminary data; supplementary data may be published later.
Product specification	This data book contains final product specifications.

Revision History

Date	Revision	Description
Sep 2006	1.00W	Official release





Copyright Notice

Copyright 1997 - 2006
Alcor Micro Corp.
All Rights Reserved.

Trademark Acknowledgements

The company and product names mentioned in this document may be the trademarks or registered trademarks of their manufacturers.

Disclaimer

Alcor Micro Corp. reserves the right to change this product without prior notice. Alcor Micro Corp. makes no warranty for the use of its products and bears no responsibility for any error that appear in this document. Specifications are subject to change without prior notice.

Contact Information:

Web site: <http://www.alcormicro.com/>

Taiwan

Alcor Micro Corp.
4F, No 200 Kang Chien Rd., Nei Hu,
Taipei, Taiwan, R.O.C.
Phone: 886-2-8751-1984
Fax: 886-2-2659-7723

China ShenZhen Office

Rm.2407-08 ,Industrial Bank Building
No.4013, Shennan Road ,ShenZhen,China.
518026
Phone: (0755) 8366-9039
Fax: (0755) 8366-9101

Santa Clara Office

2901 Tasman Drive, Suite 206
Santa Clara, CA 95054
USA
Phone: (408) 845-9300
Fax: (408) 845-9086

Los Angeles Office

9070 Rancho Park Court
Rancho Cucamonga, CA 91730
USA
Phone: (909) 483-9900
Fax: (909) 944-0464





Table of Contents

1	<u>Introduction</u>	6
	1.1 <u>Description</u>	6
	1.2 <u>Features</u>	6
2	<u>Application Block Diagram</u>	7
3	<u>Pin Assignment</u>	8
4	<u>System Architecture and Reference Design</u>	15
	4.1 <u>AU6254 Block Diagram</u>	15
	4.2 <u>USB 2.0 Hub Descriptor</u>	16
5	<u>Electrical Characteristics</u>	21
	5.1 <u>Absolute Maximum Ratings</u>	21
	5.2 <u>Recommended Operating Conditions</u>	21
	5.3 <u>Leakage Current and Capacitance</u>	21
	5.4 <u>DC Electrical Characteristics for 3.3 volts operation</u>	22
	5.5 <u>Crystal Oscillator Circuit Setup for Characterization</u>	23
	5.6 <u>Bus Timing/Electrical Characteristics</u>	23
6	<u>Mechanical Information</u>	27
7	<u>Abbreviations</u>	29





List of Figures

2.1	Block Diagram	7
3.1	48 Pin Assignment Diagram	8
3.2	64 Pin Assignment Diagram	11
4.1	AU6254 Block Diagram	15
5.1	Crystal Oscillator Circuit Setup for Characterization	23
6.1	48 Pin Mechanical Information Diagram	27
6.2	64 Pin Mechanical Information Diagram	28

List of Tables

3.1	48 Pin Descriptions	9
3.2	64 Pin Descriptions	12
4.1	Hub EEPROM Sample Value	16
5.1	Absolute Maximum Ratings	21
5.2	Recommended Operating Conditions	21
5.3	General DC Characteristics	21
5.4	DC Electrical Characteristics for 3.3 volts operation	22
5.5	DC Electrical Characteristics	23
5.6	High-speed Source Electrical Characteristics	24
5.7	Full-speed Source Electrical Characteristics	25
5.8	Low-speed Source Electrical Characteristics	26





1.0 Introduction

1.1 Description

AU6254 is a fully compliant with the USB 2.0 hub specification and is designed to work with USB host as a high-speed hub. Its built-in TT (Transaction Translator) allows system to benefit combinational performance under the unbalanced traffic condition.

AU6254 supports four USB downstream ports and one upstream port. Each downstream port could be a device of high-speed, full-speed or low-speed traffic, while the upstream port supports both high-speed and full-speed traffic. For each downstream port it has individual power switch control built-in as over-current sensing control.

In addition to the application as a stand-alone hub, AU6254 is also very suitable for using in notebook and motherboard design to provide additional USB port. All these product advantages should be attributed to its compliance to standards, performance and low power consumption.

1.2 Features

- Fully compliant with USB Hub Specification version 2.0 and is also backward compatible with USB Hub specification 1.1.
- Single chip USB 2.0 hub controller.
- Supports four bus-powered/self-powered downstream ports.
- Supports automatic switching between bus- and self-powered modes.
- Cost effective design using one transaction translator for all downstream ports.
- Two-color LED controls available for each downstream port to indicate the status of each device port.
- Extra low power consumption.
- On chip internal pull-up and meets USB bus power regain emend pull down resistors for all data line.
- Built-in USB 2.0 transceiver.
- Supports individual and gang modes of power management.
- Built-in power switch control for over current sensing control.
- Built-in 1.8V regulator for core logic.
- Embedded in PLL (Phase Lock Loop) circuit for 12MHz operation precision
- Supports external EEPROM interface for customized PID and VID
- Available in two different form factors: 48-pin LQFP package and 64-pin LQFP package.





2.0 Application Block Diagram

AU6254 is a single chip 4-port USB hub controller. Its upstream port is connected to a USB Host system. The downstream ports can be used for a mouse, joystick, scanner, printer or other devices.

Figure 2.1 Block Diagram

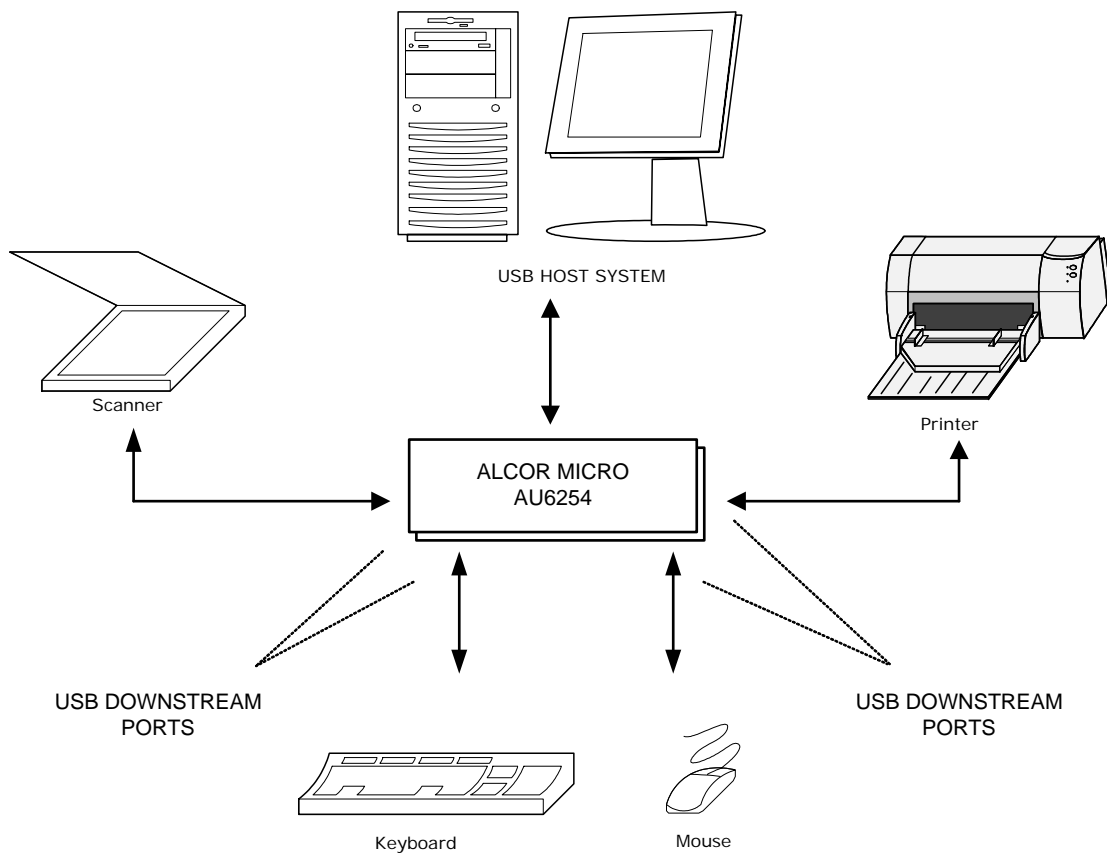



3.0 Pin Assignment

Depending on the occasion of various applications, there are two different form factors of AU6254 is available to choose from. One is in 48-pin LQFP package, while the other is in 64-pin LQFP package. With more control pins available, 64-pin package offers extra features, such as individual powered, in addition to the features found in 48-pin package. The figure printed below shows the signal names of 48-pin and the table in the page after describes each pin in detail.

Figure 3.1 Pin Assignment Diagram

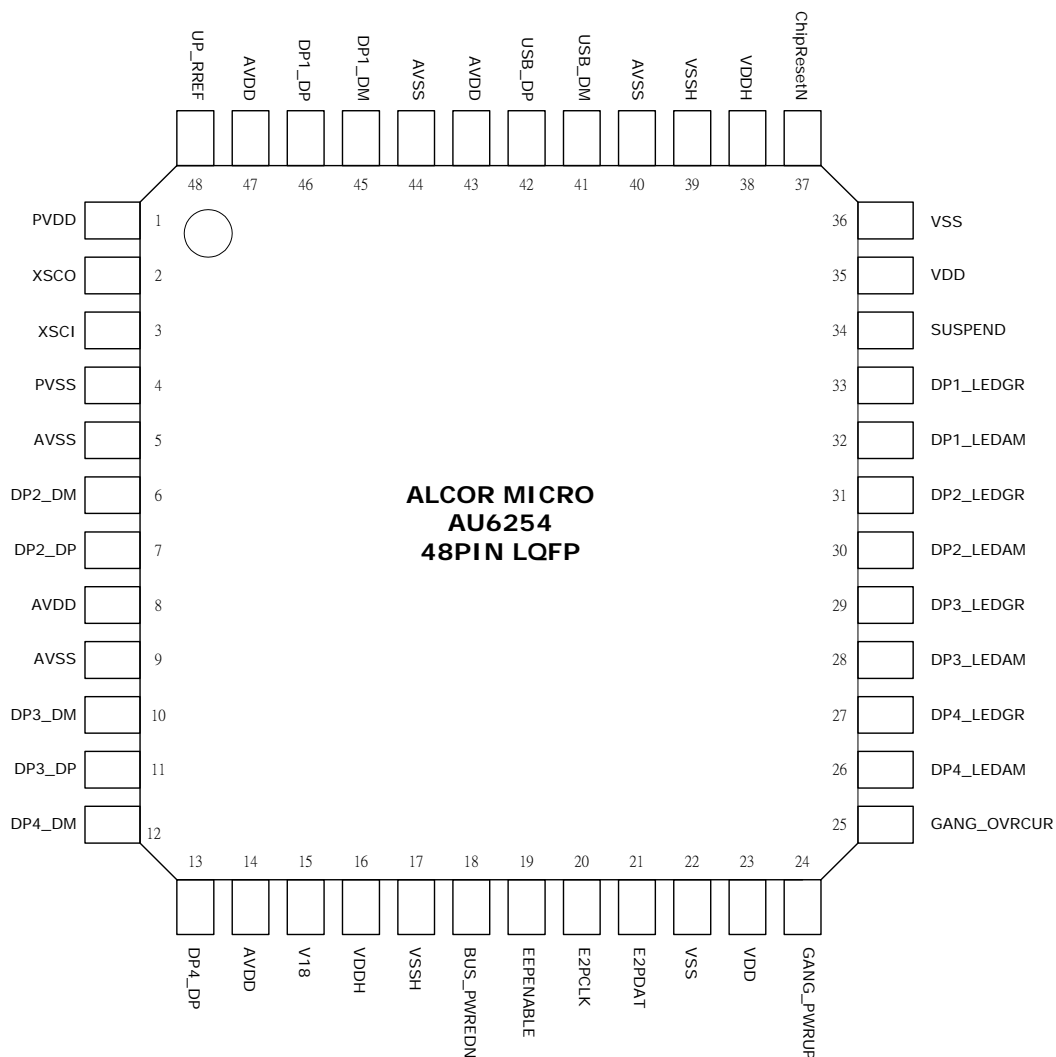



Table 3.1 48 Pin Descriptions

Pin #	Pin Name	I/O	Description
1	PVDD	Power	PLL power (3.3V)
2	XSCO	O	Oscillator output 12MHz Crystal
3	XSCI	I	Oscillator input 12MHz Crystal
4	PVSS	Power	PLL GND
5	AVSS	Power	UTMI GND
6	DP2_DM	I/O	Port2 USB differential data bus D-
7	DP2_DP	I/O	Port2 USB differential data bus D+
8	AVDD	Power	UTMI Power
9	AVSS	Power	UTMI GND
10	DP3_DM	I/O	Port3 USB differential data bus D-
11	DP3_DP	I/O	Port3 USB differential data bus D+
12	DP4_DM	I/O	Port4 USB differential data bus D-
13	DP4_DP	I/O	Port4 USB differential data bus D+
14	AVDD	Power	UTMI Power
15	V18	Power	Voltage regulator output 1.8V
16	VDDH	Power	Voltage regulator input 3.3V
17	VSSH	Power	IO GND
18	BUS_PWREDN	I	'1' = Self Powered '0' = Bus Powered
19	EEPENABLE	I	EEPROM Enable '0' = Use internal ROM '1' = Use EEP contents
20	E2PCLK	I/O	EEP Clock; with internal pull up resistor; open drain output.
21	E2PDAT	I/O	EEP Data; with internal pull up resistor; open drain output.
22	VSS	Power	Core GND
23	VDD	Power	Core Power 1.8V
24	GANG_PWRUP	O	Gang PowerEnable; open collector output (require external pull up resistor to properly control power switch) '0' = power on '1' = power off
25	GANG_OVRCUR	I	Gang Overcurrent; with internal pull up resistor; 8ms delay filter '0' = overcurrent '1' = not overcurrent
26	DP4_LEDAM	O	Port4 Amber LED indicator; with internal pull up resistor; open collector output. '0' = LED on (Error condition) '1' = LED off





Pin #	Pin Name	I/O	Description
27	DP4_LEDGR	O	Port4 Green LED indicator; with internal pull up resistor; open collector output. '0' = LED on (Port is enable) '1' = LED off
28	DP3_LEDAM	O	Port3 Amber LED indicator; with internal pull up resistor; open collector output. '0' = LED on (Error condition) '1' = LED off
29	DP3_LEDGR	O	Port3 Green LED indicator; with internal pull up resistor; open collector output. '0' = LED on (Port is enable) '1' = LED off
30	DP2_LEDAM	O	Port2 Amber LED indicator; with internal pull up resistor; open collector output. '0' = LED on (Error condition) '1' = LED off
31	DP2_LEDGR	O	Port2 Green LED; with internal pull up resistor; open collector output. '0' = LED on (Port is enable) '1' = LED off
32	DP1_LEDAM	O	Port1 Amber LED indicator; with internal pull up resistor; open collector output. '0' = LED on (Error condition) '1' = LED off
33	DP1_LEDGR	O	Port1 Green LED indicator; with internal pull up resistor; open collector output. '0' = LED on (Port is enable) '1' = LED off
34	SUSPEND	O	'0' = Not Suspended '1' = Suspended
35	VDD	Power	Core Power 1.8V
36	VSS	Power	Core GND
37	ChipResetN	I	0' = Reset '1' = Run
38	VDDH	Power	Voltage regulator input 3.3V
39	VSSH	Power	IO GND
40	AVSS	Power	UTMI GND
41	USB_DM	I/O	Upstream port USB differential data bus D-
42	USB_DP	I/O	Upstream port USB differential data bus D+
43	AVDD	Power	UTMI Power
44	AVSS	Power	UTMI GND
45	DP1_DM	I/O	Port1 USB differential data bus D-
46	DP1_DP	I/O	Port1 USB differential data bus D+
47	AVDD	Power	UTMI Power
48	UP_RREF	I	Reference Resistor





The following figure shows signal names of each pin found in 64-pin package and the table in the page after describes each pin in detail.

Figure 3.2 Pin Assignment Diagram

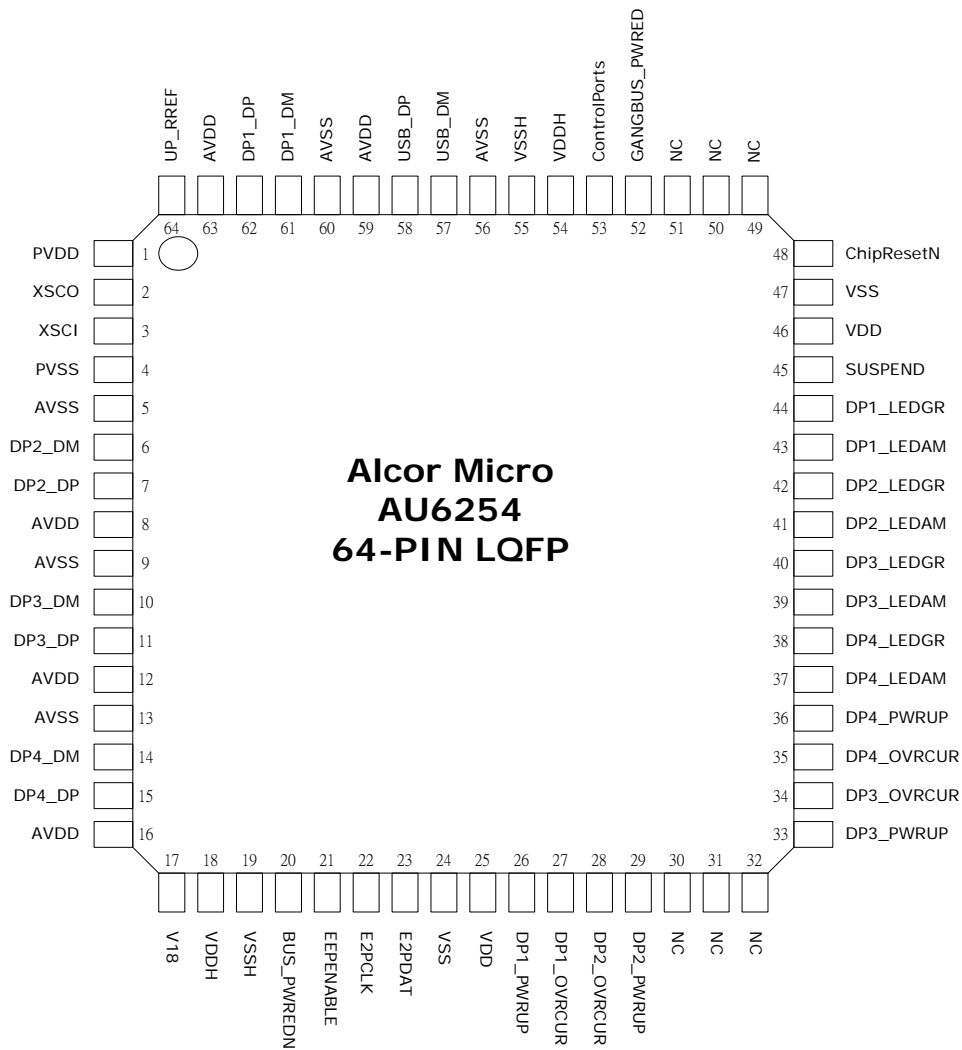



Table 3.1 64 Pin Descriptions

Pin #	Pin Name	I/O	Description
1	PVDD	Power	PLL power (3.3V)
2	XSCO	O	Oscillator output 12MHz Crystal
3	XSCI	I	Oscillator input 12MHz Crystal
4	PVSS	Power	PLL GND
5	AVSS	Power	UTMI GND
6	DP2_DM	I/O	Port2 USB differential data bus D-
7	DP2_DP	I/O	Port2 USB differential data bus D+
8	AVDD	Power	UTMI Power
9	AVSS	Power	UTMI GND
10	DP3_DM	I/O	Port3 USB differential data bus D-
11	DP3_DP	I/O	Port3 USB differential data bus D+
12	AVDD	Power	UTMI Power
13	AVSS	Power	UTMI GND
14	DP4_DM	I/O	Port4 USB differential data bus D-
15	DP4_DP	I/O	Port4 USB differential data bus D+
16	AVDD	Power	UTMI Power
17	V18	Power	Voltage regulator output 1.8V
18	VDDH	Power	Voltage regulator input 3.3V
19	VSSH	Power	IO GND
20	BUS_PWREDN	O	'1' = Self Powered '0' = Bus Powered
21	EEPENABLE	I	EEPROM Enable '0' = Use internal ROM '1' = Use EEP contents
22	E2PCLK	I/O	EEP Clock; with internal pull up resistor; open drain output.
23	E2PDAT	I/O	EEP Data; with internal pull up resistor; open drain output.
24	VSS	Power	Core GND
25	VDD	Power	Core Power 1.8V
26	DP1_PWRUP	O	Port1 PowerEnable; open collector output (require external pull up resistor to properly control power switch) '0' = power on '1' = power off
27	DP1_OVRCUR	I	Port 1 Overcurrent; with internal pull up resistor; 8ms delay filter '0' = overcurrent '1' = not overcurrent
28	DP2_OVRCUR	I	Port 2 Overcurrent; with internal pull up resistor; 8ms delay filter '0' = overcurrent '1' = not overcurrent





Pin #	Pin Name	I/O	Description
29	DP2_PWRUP	O	Port2 PowerEnable; open collector output (require external pull up resistor to properly control power switch) '0' = power on '1' = power off
30	NC		
31	NC		
32	NC		
33	DP3_PWRUP	O	Port3 PowerEnable; open collector output (require external pull up resistor to properly control power switch) '0' = power on '1' = power off
34	DP3_OVRCUR	I	Port3 Overcurrent; with internal pull up resistor; 8ms delay filter '0' = overcurrent '1' = not overcurrent
35	DP4_OVRCUR	I	Port4 Overcurrent; with internal pull up resistor 8ms delay filter '0' = overcurrent '1' = not overcurrent
36	DP4_PWRUP	O	Port4 PowerEnable; open collector output (require external pull up resistor to properly control power switch) '0' = power on '1' = power off
37	DP4_LEDAM	O	Port4 Amber LED indicator; with internal pull up resistor; open collector output. '0' = LED on (Error condition) '1' = LED off
38	DP4_LEDGR	O	Port4 Green LED indicator; with internal pull up resistor; open collector output. '0' = LED on (Port is enable) '1' = LED off
39	DP3_LEDAM	O	Port3 Amber LED indicator; with internal pull up resistor; open collector output. '0' = LED on (Error condition) '1' = LED off
40	DP3_LEDGR	O	Port3 Green LED indicator; with internal pull up resistor; open collector output. '0' = LED on (Port is enable) '1' = LED off
41	DP2_LEDAM	O	Port2 Amber LED indicator; with internal pull up resistor; open collector output. '0' = LED on (Error condition) '1' = LED off
42	DP2_LEDGR	O	Port2 Green LED; with internal pull up resistor; open collector output. '0' = LED on (Port is enable) '1' = LED off





Pin #	Pin Name	I/O	Description
43	DP1_LEDAM	O	Port1 Amber LED indicator; with internal pull up resistor; open collector output. '0' = LED on (Error condition) '1' = LED off
44	DP1_LEDGR	O	Port1 Green LED indicator; with internal pull up resistor; open collector output. '0' = LED on (Port is enable) '1' = LED off
45	SUSPEND	O	'0' = Not Suspended '1' = Suspended
46	VDD	Power	Core Power 1.8V
47	VSS	Power	Core GND
48	ChipResetN	I	'0' = Reset '1' = Run
49	NC		
50	NC		
51	NC		
52	GANGBUS_PWRED	I	Gang bus powered, it has a internal pull down resistor '1' = Individual Power '0' = Gang powered
53	ControlPorts	I	Internal pull down resistor '0' = Normal hub '1' = PortControl
54	VDDH	Power	Voltage regulator input 3.3V
55	VSSH	Power	IO GND
56	AVSS	Power	UTMI GND
57	USB_DM	I/O	Upstream port USB differential data bus D-
58	USB_DP	I/O	Upstream port USB differential data bus D+
59	AVDD	Power	UTMI Power
60	AVSS	Power	UTMI GND
61	DP1_DM	I/O	Port1 USB differential data bus D-
62	DP1_DP	I/O	Port1 USB differential data bus D+
63	AVDD	Power	UTMI Power
64	UP_RREF	I	Reference Resistor



4.0 System Architecture and Reference Design

4.1 AU6254 Block Diagram

Figure4.1 AU6254 Block Diagram

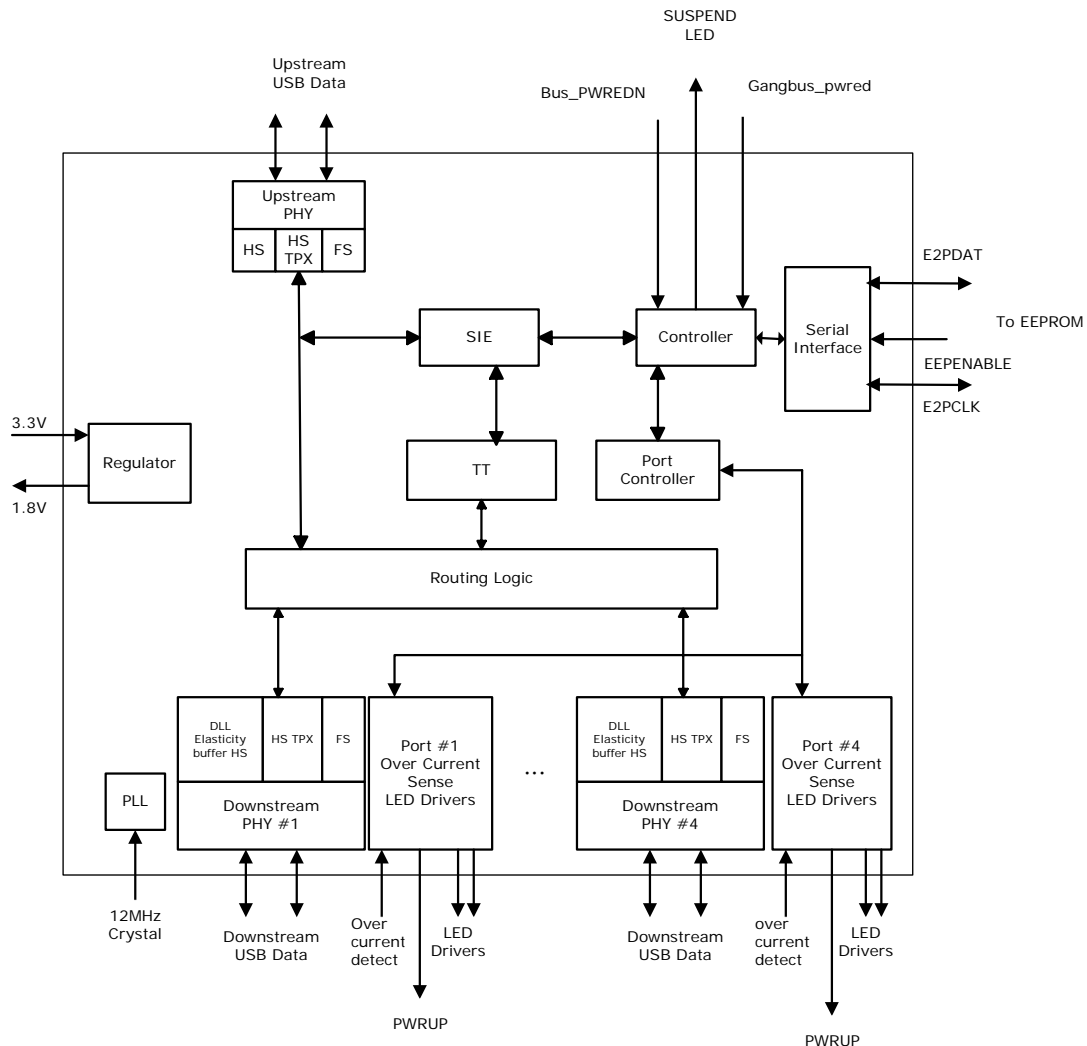



4.2 USB 2.0 Hub Descriptor

Table 4.1 Hub EEPROM Sample Value

OFFSET (BYTE, HEX)	LENGTH (BYTE, HEX)	VALUES (HEX)	DESCRIPTION
0	2	01,00	Configuration Byte 1 bit 0 : EnablePortError
2	2	1A,2C	LoByte : Pointer to Hub FS device descriptor 000h ROM address HiByte : Xfer end address + 1
4	2	2C,45	LoByte : Pointer to Hub FS configuration descriptor HiByte : Xfer end address + 1 (config+interface+endpoint) 000h ROM address
6	2	45,4F	LoByte : Pointer to Hub FS Device Qualifier descriptor HiByte : Xfer end address + 1 000h ROM address
8	2	4F,68	LoByte : Pointer to Hub FS Other Speed Configuration descriptor HiByte : Xfer end address + 1 (config+interface+endpoint) 000h ROM address
A	2	78,8A	LoByte : Pointer to Hub HS device descriptor 000h ROM address HiByte : Xfer end address + 1
C	2	8A,A3	LoByte : Pointer to Hub HS configuration descriptor HiByte : Xfer end address + 1 (config+interface+endpoint) 000h ROM address
E	2	B3,BD	LoByte : Pointer to Hub HS Device Qualifier descriptor HiByte : Xfer end address + 1 000h ROM address
10	2	BD,D6	LoByte : Pointer to Hub HS Other Speed Configuration descriptor HiByte : Xfer end address + 1 (config+interface+endpoint) 000h ROM address
12	2	D6,DF	LoByte : Pointer to HUB Class descriptor (0x29) 000h ROM address HiByte : Xfer end address + 1 Individual power
14	2	DF,E8	LoByte : Pointer to HUB Class descriptor (0x29) 000h ROM address HiByte : Xfer end address + 1 Gang Power
16	2	18,1A	LoByte : Pointer to Special Command Data 000h ROM address HiByte : Xfer end address + 1
18	2	01,00	
1A	12	12,01,00,02,09 ,00,00,40,8F,0 5,54,62,00,01, 00,00,00,01	Hub FS device descriptor, version 2.0, 12 Descriptor length 01 Device Descriptor 00 02 USB Version 2.0 09 Hub class 00 Sub-class 00 Device Protocol 40h Maximum packet size 8F 05 Vender ID – Alcor 54 62 Product ID - 6254 01 00 Device release number 00 Index of Manufacturer string descriptor 00 Index of Product string descriptor 00 Index of serial number string descriptor – no serial number 01 Number of configuration
2C	9	09,02,19,00,01 ,01,00,E0,FA	Hub FS Config Desc. 1 interface, self powered, remote wakeup,500 mA Total bytes returned : 0x19
35	9	09,04,00,00,01 ,09,00,00,00	Hub FS interface descriptor, interface 0. Class code 0x9
3E	7	07,05,81,03,01 ,00,FF	Hub FS endpoint descriptor
45	A	0A,06,00,02,09 ,00,01,40,01,0 0	Hub FS Device Qualifier descriptor - USB 2.00,





OFFSET (BYTE, HEX)	LENGTH (BYTE, HEX)	VALUES (HEX)	DESCRIPTION
4F	9	09,07,19,00,01,01,00,E0,FA	Hub FS Other Speed Config Desc. 1 interface, self powered, remote wakeup, 500 mA Total bytes returned : 0x19
58	9	09,04,00,00,01,09,00,00,00	Hub FS Other speed interface descriptor, interface 0. Class code 0x9, single TT
61	7	07,05,81,03,01,00,0C	Hub FS Other speed endpoint descriptor
68	9	09,04,00,01,01,09,00,02,00	Hub FS Other speed interface descriptor, interface 0. Class code 0x9, single TT
71	7	07,05,81,03,01,00,0C	Hub FS Other speed endpoint descriptor
78	12	12,01,00,02,09,00,01,40,8F,05,54,62,00,01,00,00,00,01	Hub HS device descriptor, version 2.0, 12 Descriptor length 01 Device Descriptor 00 02 USB Version 2.0 09 Hub class 01 Sub-class – (single TTs) 00 Device Protocol 40h Maximum packet size 8F 05 Vender ID – Alcor 54 62 Product ID - 6254 01 00 Device release number 00 Index of Manufacturer string descriptor 00 Index of Product string descriptor 00 Index of serial number string descriptor – no serial number 01 Number of configuration
8A	9	09,02,19,00,01,01,00,E0,FA	Hub HS Config Desc. 1 interface, self powered, remote wakeup, 500 mA Total bytes returned : 0x19
93	9	09,04,00,00,01,09,00,00,00	Hub HS interface descriptor, interface 0. Class code 0x9, single TT
9C	7	07,05,81,03,01,00,0C	Hub HS endpoint descriptor
A3	9	09,04,00,01,01,09,00,02,00	Hub HS interface descriptor, interface 0. Class code 0x9, formultipleTT
AC	7	07,05,81,03,01,00,0C	Hub HS endpoint descriptor
B3	A	0A,06,00,02,09,00,00,40,01,00	Hub HS Device Qualifier descriptor - USB 2.00,
BD	9	09,07,19,00,01,01,00,E0,FA	Hub HS Other speed Config Desc. 1 interface, self powered, remote wakeup, 500 mA Total bytes returned : 0x19
C6	9	09,04,00,00,01,09,00,00,00	Hub HS Other speed interface descriptor, interface 0. Class code 0x9
CF	7	07,05,81,03,01,00,FF	Hub HS Other speed endpoint descriptor
D6	9	09,29,04,89,00,32,64,00,FF	Hub class descriptor. 09 Descriptor length 29 Hub Descriptor 04 Number of downstream port –4 external ports A9 00 Individual Over-current sensing, individual power switch, 8 FS bit TT think time, port indicators supported 32 Power good wait time 32hx2 mS (=100ms) 64 Maximum current required (=100mA) 00 No ports are not removable FF Port power control mask





OFFSET (BYTE, HEX)	LENGTH (BYTE, HEX)	VALUES (HEX)	DESCRIPTION
DF	9	09,29,04,80,00 ,32,64,00,FF	Hub class descriptor. 09 Descriptor length 29 Hub Descriptor 04 Number of downstream port – 4 external ports A0 00 Global Over-current sensing, gang power switch, 8 FS bit TT think time, port indicators supported 32 Power good wait time 32hx2 mS (=100ms) 64 Maximum current required (=100mA) 00 No ports are not removable FF Port power control mask
E8	18	00,00,00,00,00 ,00,00,00, 00,00,00,00,00 ,00,00,00, 00,00,00,00,00 ,00,00,00,	Spare bytes
100	2	01,00	Configuration Byte 1 bit 0 : EnablePortError Byte 1 bit 1 :
102	2	1A,2C	LoByte : Pointer to Hub FS device descriptor 000h ROM address HiByte : Xfer end address + 1
104	2	2C,45	LoByte : Pointer to Hub FS configuration descriptor HiByte : Xfer end address + 1 (config+interface+endpoint) 000h ROM address
106	2	45,4F	LoByte : Pointer to Hub FS Device Qualifier descriptor HiByte : Xfer end address + 1 000h ROM address
108	2	4F,68	LoByte : Pointer to Hub FS Other Speed Configuration descriptor HiByte : Xfer end address + 1 (config+interface+endpoint) 000h ROM address
10A	2	78,8A	LoByte : Pointer to Hub HS device descriptor 000h ROM address HiByte : Xfer end address + 1
10C	2	8A,A3	LoByte : Pointer to Hub HS configuration descriptor HiByte : Xfer end address + 1 (config+interface+endpoint) 000h ROM address
10E	2	B3,BD	LoByte : Pointer to Hub HS Device Qualifier descriptor HiByte : Xfer end address + 1 000h ROM address
110	2	BD,D6	LoByte : Pointer to Hub HS Other Speed Configuration descriptor HiByte : Xfer end address + 1 (config+interface+endpoint) 000h ROM address
112	2	D6,DF	LoByte : Pointer to HUB Class descriptor (0x29) 000h ROM address HiByte : Xfer end address + 1 Individual power
114	2	DF,E8	LoByte : Pointer to HUB Class descriptor (0x29) 000h ROM address HiByte : Xfer end address + 1 Gang Power
116	2	18,1A	LoByte : Pointer to Special Command Data 000h ROM address HiByte : Xfer end address + 1
118	2	01,00	
11A	12	12,01,00,02,09 ,00,00,40,8F,0 5,54,62,00,01, 00,00,00,01	Hub FS device descriptor, version 2.0, 12 Descriptor length 01 Device Descriptor 00 02 USB Version 2.0 09 Hub class 00 Sub-class 00 Device Protocol 40h Maximum packet size 8F 05 Vender ID – Alcor 54 62 Product ID - 6254 01 00 Device release number 00 Index of Manufacturer string descriptor 00 Index of Product string descriptor 00 Index of serial number string descriptor – no serial number 01 Number of configuration





OFFSET (BYTE, HEX)	LENGTH (BYTE, HEX)	VALUES (HEX)	DESCRIPTION
12C	9	09,02,19,00,01 ,01,00,E0,32	Hub FS Config Desc. 1 interface, self powered, remote wakeup,100 mA Total bytes returned : 0x19
135	9	09,04,00,00,01 ,09,00,00,00	Hub FS interface descriptor, interface 0. Class code 0x9
13E	7	07,05,81,03,01 ,00,FF	Hub FS endpoint descriptor
145	A	0A,06,00,02,09 ,00,01,40,01,0 0	Hub FS Device Qualifier descriptor - USB 2.00,
14F	9	09,07,19,00,01 ,01,00,E0,32	Hub FS Other Speed Config Desc. 1 interface, self powered, remote wakeup, 100 mA Total bytes returned : 0x19
158	9	09,04,00,00,01 ,09,00,00,00	Hub FS Other speed interface descriptor, interface 0. Class code 0x9, single TT
161	7	07,05,81,03,01 ,00,0C	Hub FS Other speed endpoint descriptor
168	9	09,04,00,01,01 ,09,00,02,00	Hub FS Other speed interface descriptor, interface 0. Class code 0x9, single TT
171	7	07,05,81,03,01 ,00,0C	Hub FS Other speed endpoint descriptor
178	12	12,01,00,02,09 ,00,01,40,8F,0 5,54,62,00,01, 00,00,00,01	Hub HS device descriptor, version 2.0, 12 Descriptor length 01 Device Descriptor 00 02 USB Version 2.0 09 Hub class 01 Sub-class – (single TTs) 00 Device Protocol 40h Maximum packet size 8F 05 Vender ID – Alcor 54 62 Product ID - 6254 01 00 Device release number 00 Index of Manufacturer string descriptor 00 Index of Product string descriptor 00 Index of serial number string descriptor – no serial number 01 Number of configuration
18A	9	09,02,19,00,01 ,01,00,E0,32	Hub HS Config Desc. 1 interface, self powered, remote wakeup, 100 mA Total bytes returned : 0x19
193	9	09,04,00,00,01 ,09,00,00,00	Hub HS interface descriptor, interface 0. Class code 0x9, single TT
19C	7	07,05,81,03,01 ,00,0C	Hub HS endpoint descriptor
1A3	9	09,04,00,01,01 ,09,00,02,00	Hub HS interface descriptor, interface 0. Class code 0x9, formultipleTT
1AC	7	07,05,81,03,01 ,00,0C	Hub HS endpoint descriptor
1B3	A	0A,06,00,02,09 ,00,00,40,01,0 0	Hub HS Device Qualifier descriptor - USB 2.00,
1BD	9	09,07,19,00,01 ,01,00,E0,32	Hub HS Other speed Config Desc. 1 interface, self powered, remote wakeup, 100 mA Total bytes returned : 0x19
1C6	9	09,04,00,00,01 ,09,00,00,00	Hub HS Other speed interface descriptor, interface 0. Class code 0x9
1CF	7	07,05,81,03,01 ,00,FF	Hub HS Other speed endpoint descriptor





OFFSET (BYTE, HEX)	LENGTH (BYTE, HEX)	VALUES (HEX)	DESCRIPTION
1D6	9	09,29,04,89,00 ,32,64,00,FF	Hub class descriptor. 09 Descriptor length 29 Hub Descriptor 04 Number of downstream port –4 external ports A9 00 Individual Over-current sensing, individual power switch, 8 FS bit TT think time, port indicators supported 32 Power good wait time 32hx2 mS (=100ms) 64 Maximum current required (=100mA) 00 No ports are not removable FF Port power control mask
1DF	9	09,29,04,80,00 ,32,64,00,FF	Hub class descriptor. 09 Descriptor length 29 Hub Descriptor 04 Number of downstream port – 4 external ports A0 00 Global Over-current sensing, gang power switch, 8 FS bit TT think time, port indicators supported 32 Power good wait time 32hx2 mS (=100ms) 64 Maximum current required (=100mA) 00 No ports are not removable FF Port power control mask
1E8	18	00,00,00,00,00 ,00,00,00, 00,00,00,00,00 ,00,00,00, 00,00,00,00,00 ,00,00,00,	Spare bytes





5.0 Electrical Characteristics

5.1 Absolute Maximum Ratings

Table 5.1 Absolute Maximum Ratings

SYMBOL	PARAMETER	RATING	UNITS
V_{DDH}	Power Supply	- 0.3 to 4.0	V
V_{IN}	Input signal Voltage for I/O pins	-0.3 to V_{DDH}	V
V_{OUT}	Output Voltage	± 0.3 to V_{DDH}	V
T_{STG}	Storage Temperature	-40 to 150	$^{\circ}C$

5.2 Recommended Operating Conditions

Table 5.2 Recommended Operating Conditions

SYMBOL	PARAMETER	MIN	TYP	MAX	UNITS
V_{DDH}	Power Supply	3.0	3.3	3.6	V
V_{DD}	Digital Supply	1.62	1.8	1.98	V
V_{IN}	Input signal Voltage for I/O pins	0	3.3	3.6	V
T_{OPR}	Operating Temperature	0		85	$^{\circ}C$

5.3 Leakage Current and Capacitance

Table 5.3 General DC Characteristics

SYMBOL	PARAMETER	CONDITIONS	MIN	TYP	MAX	UNITS
I_{IN}	Input current	no pull-up or pull-down	-10	± 1	10	μA
I_{OZ}	Tri-state leakage current		-10	± 1	10	μA
C_{IN}	Input capacitance	Pad Limit		2.8		ρF
C_{OUT}	Output capacitance	Pad Limit		2.8		ρF
C_{BID}	Bi-directional buffer capacitance	Pad Limit		2.8		ρF





5.4 DC Electrical Characteristics for 3.3 volts operation

(Under Recommended Operating Conditions and $V_{DDH}=3.0v \sim 3.6v$, $T_j = 0^{\circ}C$ to $+85^{\circ}C$)

Table 5.4 DC Electrical Characteristics for 3.3 volts operation

SYMBOL	PARAMETER	CONDITIONS	MIN	MAX	UNITS
V_{OH}	High level output Voltage	$I_{OH} = -2, -4, -8, -16, -24mA$	2.4		V
		Programmable type: $-24mA \leq I_{OH} \leq -2mA$			
V_{OL}	Low level output voltage	$I_{OL} = 2, 4, 8, 16, 24mA$		0.4	v
		Programmable type: $2mA \leq I_{OL} \leq 24mA$			
V_{IH}	High level input voltage	CMOS interface	2.0		V
		CMOS Schmitt trigger interface	1.4	2.0	
V_{IL}	Low level input voltage	CMOS interface		0.8	V
		CMOS Schmitt trigger interface	0.8	1.2	
	Hysteresis		0.6	0.9	V
I_I	Input current	$V_{dd} = MAX, 0V \leq V_{in} \leq 5.5V$	-10	10	μA
	Input current with 40k Ω pull down	$V_{in} = V_{dd}$	40	160	μA
	Input current with 40 k Ω pull up	$V_{in} = 0$	-160	40	μA



5.5 Crystal Oscillator Circuit Setup for Characterization

The following setup was used to measure the open loop voltage gain for crystal oscillator circuits. The feedback resistor serves to bias the circuit at its quiescent operating point and the AC coupling capacitor, C_s , is much larger than C_1 and C_2 .

Figure 5.1 Crystal Oscillator Circuit Setup for Characterization

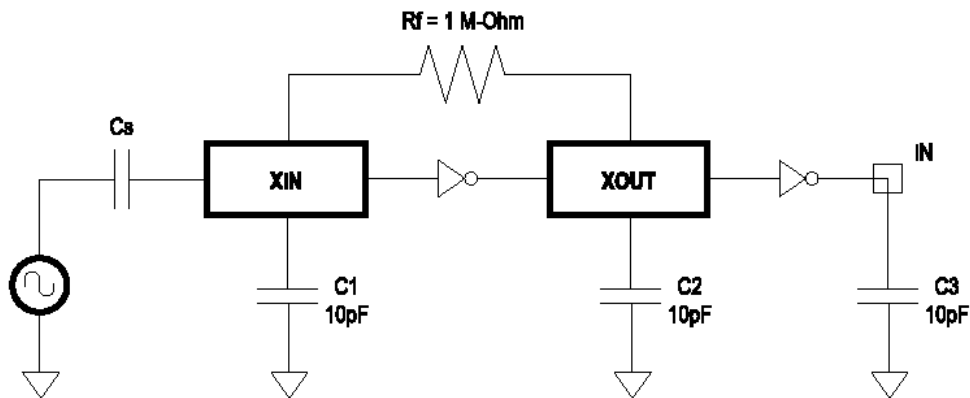

5.6 Bus Timing/Electrical Characteristics

Table 5.5 DC Electrical Characteristics

Input Levels for Low-/Full –speed:

SYMBOL	PARAMETER	LIMITS		UNIT
		MIN	MAX	
V_{IH}	High (Driven)	2.0		V
V_{IHZ}	High (floating)	2.7	3.6	V
V_{IL}	Low		0.8	V
V_{DI}	Differential Input Sensitivity	0.2		V
V_{CM}	Differential Common Mode Range	0.8	2.5	V

Input Levels for High –speed:

SYMBOL	PARAMETER	LIMITS		UNIT
		MIN	MAX	
V_{HHSSQ}	High-speed squelch detection threshold (differential signal amplitude)	100	150	mV
V_{HSDSC}	High speed disconnect detection threshold (differential signal amplitude)	525	625	mV





Output Levels for Low-/Full-speed:

SYMBOL	PARAMETER	LIMITS		UNIT
		MIN	MAX	
V _{OL}	Low	0.0	0.3	V
V _{OH}	High (driven)	2.8	3.6	V
V _{OSE1}	SE1	0.8		V
V _{CRS}	Output Signal Crossover Voltage	1.3	2.0	V

Output Levels for High –speed:

SYMBOL	PARAMETER	LIMITS		UNIT
		MIN	MAX	
V _{HSOI}	High-speed idle level	-10	10	mV
V _{HSOH}	High-speed data signaling high	360	440	mV
V _{HSOL}	High-speed data signaling low	-10	10	mV
V _{CHIRPJ}	Chirp J level (differential voltage)	700	1100	mV
V _{CHIRPK}	Chirp K level (differential voltage)	-900	-500	mV

Terminations:

SYMBOL	PARAMETER	LIMITS		UNIT
		MIN	MAX	
R _{PU}	Bus Pull-up Resistor on Upstream Facing Port	1.425	1.575	kΩ
R _{PD}	Bus Pull-down Resistor on Upstream Facing Port	14.25	15.75	kΩ
Z _{INP}	Input impedance exclusive of pull-up/pull-down (for low-/full-speed)	300		kΩ
V _{TERM}	Termination voltage for upstream facing port pull-up (R _{PU})	3.0	3.6	V

Terminations in High-speed:

SYMBOL	PARAMETER	LIMITS		UNIT
		MIN	MAX	
V _{HSTERM}	Termination voltage in high-speed	-10	10	mV

Table 5.6 High-speed Source Electrical Characteristics

Driver Characteristics:

SYMBOL	PARAMETER	LIMITS		UNIT
		MIN	MAX	
T _{HSR}	Rise Time (10%-90%)	500		ps
T _{HSF}	Fall Time (10%-90%)	500		ps
Z _{HSDRV}	Driver Output Resistance (which also serves as high-speed termination)	40.5	49.5	Ω





Clock Timings:

SYMBOL	PARAMETER	LIMITS		UNIT
		MIN	MAX	
T _{HSDRAT}	High-speed Data Rate	479.76	480.24	Mb/s
T _{HSFRAM}	Micorframe Interval	124.9375	125.0625	μs
T _{HSRFI}	Consecutive Microframe Interval Difference		4 high-speed bit times	

Table 5.7 Full-speed Source Electrical Characteristics

Driver Characteristics:

SYMBOL	PARAMETER	LIMITS		UNIT
		MIN	MAX	
T _{FR}	Rise Time	4	20	ns
T _{FF}	Fall Time	4	20	ns
T _{FRFM}	Differential Rise and Fall Time Matching	90	111.11	%
Z _{ZRV}	Driver Output Resistance for driver which is not high-speed capable	28	44	Ω

Clock Timings:

SYMBOL	PARAMETER	LIMITS		UNIT
		MIN	MAX	
T _{FDRATHS}	Full-speed Data Rate for hubs and devices which are high-speed capable	11.994	12.006	Mb/s
T _{FDRATE}	Full-speed Data Rate for devices which are not high-speed capable	11.970	12.030	Mb/s
T _{FRAME}	Frame interval	0.9995	1.0005	Ms
T _{RFI}	Consecutive Frame Interval Jitter		42	ns

Full-speed Data Timings:

SYMBOL	PARAMETER	LIMITS		UNIT
		MIN	MAX	
T _{DJ1}	Source Jitter Total(including frequency tolerance): To Next Transition For Paired Transitions	-3.5	-3.5	ns
T _{DJ2}		-4	-4	ns
T _{FDEOP}	Source Jitter for Differential Transition to SE0 Transition	-2	5	ns
T _{JR1}	Receiver Jitter: To Next Transition For Paired Transitions	-18.5	-18.5	ns
T _{JR2}		-9	-9	ns
T _{FEPPT}	Source SE0 interval of EOP	160	175	ns
T _{FEOPR}	Receiver SE0 interval of EOP	82		ns
T _{FST}	Width of SE0 interval during differential transition		14	ns





Table 5.8 Low-speed Source Electrical Characteristics

Driver Characteristics:

SYMBOL	PARAMETER	LIMITS		UNIT
		MIN	MAX	
T _{LR}	Rise Time	75	300	ns
T _{LF}	Fall Time	75	300	ns
T _{LRFM}	Differential Rise and Fall Time Matching	80	125	%
C _{LINUA}	Upstream Facing Port (w/cable, low-speed only)	200	450	pF

Clock Timings:

SYMBOL	PARAMETER	LIMITS		UNIT
		MIN	MAX	
T _{LDRATHS}	Low-speed Data Rate for hubs and devices which are high-speed capable	1.49925	1.50075	Mb/s
T _{LDRATE}	Low-speed Data Rate for devices which are not high-speed capable	1.4775	1.5225	Mb/s

Low-speed Data Timings:

SYMBOL	PARAMETER	LIMITS		UNIT
		MIN	MAX	
T _{UDJ1} T _{UDJ2}	Upstream facing port source Jitter Total(including frequency tolerance):	-95	95	ns
	To Next Transition	-150	150	ns
T _{LD EOP}	For Paired Transitions			
T _{LD EOP}	Upstream facing port source Jitter for Differential Transition to SE0 Transition	-40	100	ns
T _{DJR1} T _{DJR2}	Upstream facing port differential Receiver Jitter:			
	To Next Transition	-75	75	ns
T _{DDJ1} T _{DDJ2}	For Paired Transitions	-45	45	ns
	Upstream facing port differential Receiver Jitter:			
T _{DDJ1} T _{DDJ2}	To Next Transition	-25	25	ns
	For Paired Transitions	-14	14	ns
T _{UJR1} T _{UJR2}	Downstream facing port Differential Receiver Jitter:			
	To Next Transition	-152	152	ns
T _{LEOPT}	For Paired Transitions	-200	200	ns
	Source SE0 interval of EOP	1.25	1.50	μs
T _{LEOPR}	Receiver SE0 interval of EOP	670		ns
T _{LST}	Width of SE0 interval during differential transition		210	ns





6.0 Mechanical Information

Figure 6.1 48 Pin Mechanical Information Diagram

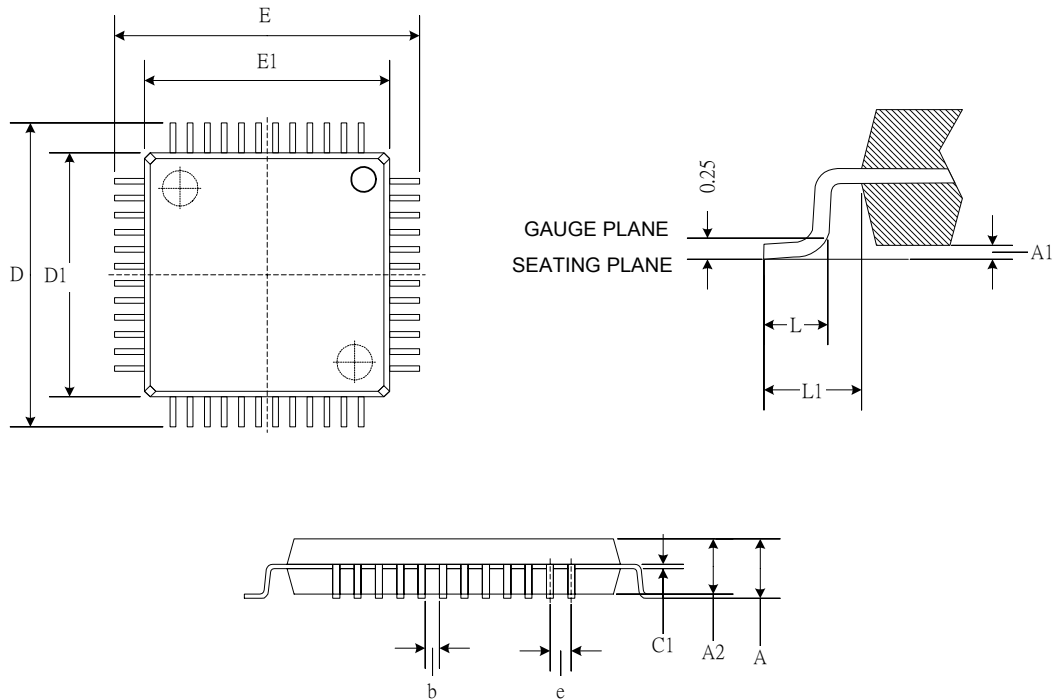

SYMBOLS	MIN.	MAX.
A	--	1.6
A1	0.05	0.15
A2	1.35	1.45
c1	0.09	0.16
D	9.00 BSC	
D1	7.00 BSC	
E	9.00 BSC	
E1	7.00 BSC	
e	0.5 BSC	
b	0.17	0.27
L	0.45	0.75
L1	1 REF	

1. JEDEC OUTLINE: MS-026 BBC
2. DIMENSIONS D1 AND E1 DO NOT INCLUDE MOLD PROTRUSION. ALLOWABLE PROTRUSION IS 0.25mm PER SIDE. D1 AND E1 ARE MAXIMUM PLASTIC BODY SIZE DIMENSIONS INCLUDING MOLD MISMATCH.
3. DIMENSION b DOES NOT INCLUDE DAMBAR PROTRUSION. ALLOWABLE DAMBAR PROTRUSION SHALL NOT CAUSE THE LEAD WIDTH TO EXCEED THE MAXIMUM b DIMENSION BY MORE THAN 0.08mm





Figure 6.2 64 Pin Mechanical Information Diagram

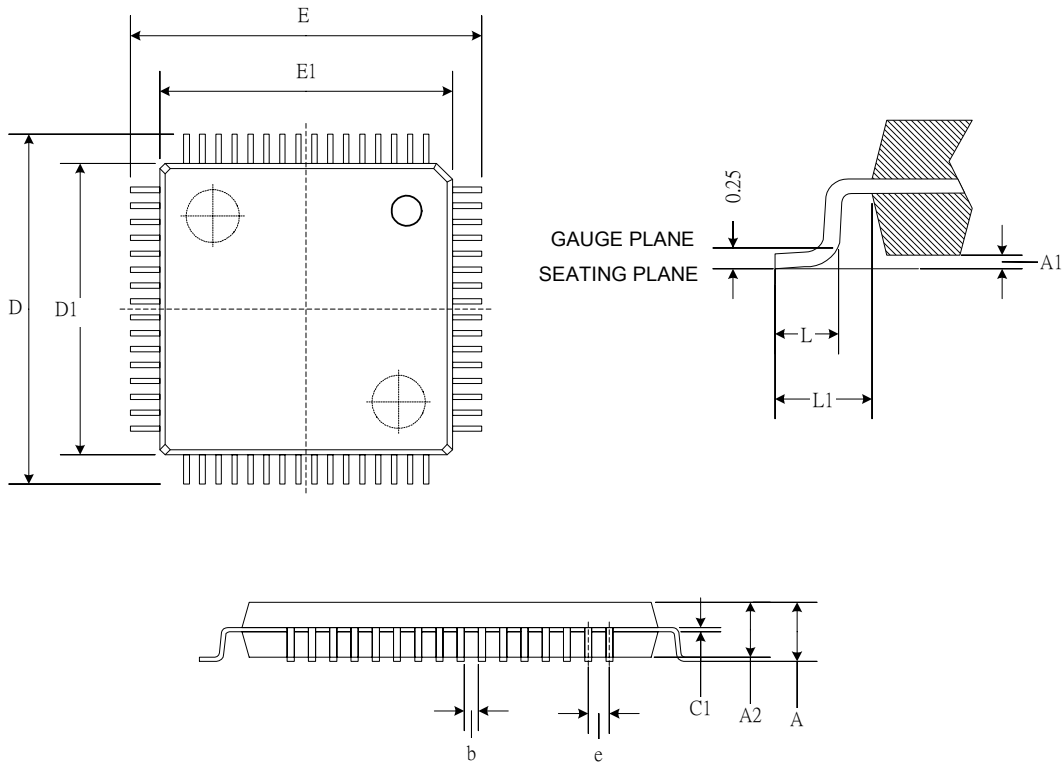

SYMBOLS	MIN.	MAX.
A	--	1.60
A1	0.05	0.15
A2	1.35	1.45
b	0.17	0.27
c1	0.09	0.16
D	12.00 BSC	
D1	10.00 BSC	
E	12.00 BSC	
E1	10.00 BSC	
e	0.50 BSC	
L	0.45	0.75
L1	1.00 REF	

1. JEDEC OUTLINE: MS-026 BCD
2. DIMENSIONS D1 AND E1 DO NOT INCLUDE MOLD PROTRUSION. ALLOWABLE PROTRUSION IS 0.25mm PER SIDE. D1 AND E1 ARE MAXIMUM PLASTIC BODY SIZE DIMENSIONS INCLUDING MOLD MISMATCH.
3. DIMENSION b DOES NOT INCLUDE DAMBAR PROTRUSION. ALLOWABLE DAMBAR PROTRUSION SHALL NOT CAUSE THE LEAD WIDTH TO EXCEED THE MAXIMUM b DIMENSION BY MORE THAN 0.08mm.





7.0 Abbreviations

This chapter lists and defines terms and abbreviations used throughout this specification.

SIE	Serial Interface Engine
UTMI	USB Transceiver Macrocell Interface





Alcor Micro Corp.

[Http://www.alcormicro.com/](http://www.alcormicro.com/)

【MEMO】

About Alcor Micro, Corp

Alcor Micro, Corp. designs, develops and markets highly integrated and advanced peripheral semiconductor, and software driver solutions for the personal computer and consumer electronics markets worldwide. We specialize in USB solutions and focus on emerging technology such as USB and IEEE 1394. The company offers a range of semiconductors including controllers for USB hub, integrated keyboard/USB hub and USB Flash memory card reader...etc. Alcor Micro, Corp. is based in Taipei, Taiwan, with sales offices in Taipei, Japan, Korea and California.

Alcor Micro is distinguished by its ability to provide innovative solutions for spec-driven products. Innovations like single chip solutions for traditional multiple chip products and on-board voltage regulators enable the company to provide cost-efficiency solutions for the computer peripheral device OEM customers worldwide.

