



## Technical Data Sheet

### 1.5mm Side Face Infrared LED

#### IR928-6C-F

#### Features

- High reliability
- High radiant intensity
- Peak wavelength  $\lambda_p=940\text{nm}$
- 2.54mm Lead spacing
- Low forward voltage
- Pb.Free
- This product itself will remain within RoHS compliant version.



#### Descriptions

- EVERLIGHT's Infrared Emitting Diode (IR928-6C-F) is a high intensity diode, molded in a water clear plastic package.
- The miniature side-facing device has a chip, that emits radiation from the side of the clear package.

#### Applications

- Mouse
- Optoelectronic switch
- Infrared applied system

#### Device Selection Guide

LED Part No.	Chip	Lens Color
	Material	
IR928-6C-F	GaAlAs	Water clear

**Package Dimensions**

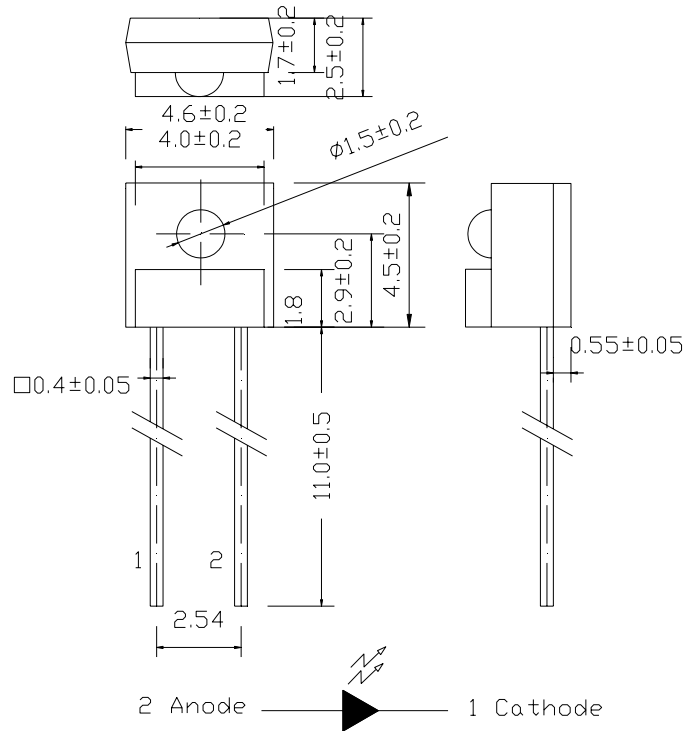

- Notes:** 1.All dimensions are in millimeters  
 2.Tolerances unless dimensions  $\pm 0.25\text{mm}$

**Absolute Maximum Ratings (Ta=25°C)**

Parameter	Symbol	Rating	Units
Continuous Forward Current	$I_F$	50	mA
Peak Forward Current(*1)	$I_{FP}$	1.0	A
Reverse Voltage	$V_R$	5	V
Operating Temperature	$T_{opr}$	-25 ~ +85	°C
Storage Temperature	$T_{stg}$	-40 ~ +85	°C
Soldering Temperature(*2)	$T_{sol}$	260	°C
Power Dissipation at(or below) 25°C Free Air Temperature	$P_d$	75	mW

- Notes:** \*1: $I_{FP}$  Conditions--Pulse Width  $\leq 100 \mu s$  and Duty  $\leq 1\%$ .  
 \*2:Soldering time  $\leq 5$  seconds.

**Electro-Optical Characteristics (Ta=25°C)**

Parameter	Symbol	Condition	Min.	Typ.	Max.	Units
Light Current	Ic(ON)	I <sub>F</sub> =4mA, V <sub>CE</sub> =3.5V	265	--	1870	μA
Peak Wavelength	λ <sub>p</sub>	I <sub>F</sub> =20mA	--	940	--	nm
Spectral Bandwidth	Δλ	I <sub>F</sub> =20mA	--	50	--	nm
Forward Voltage	V <sub>F</sub>	I <sub>F</sub> =20mA	--	1.2	1.5	V
Reverse Current	I <sub>R</sub>	V <sub>R</sub> =5V	--	--	10	μA
View Angle	2θ 1/2	I <sub>F</sub> =20mA	--	40	--	deg

**Wide Rank**

Parameter	Symbol	Min	Max	Unit	Test Condition
5-2	Ic(ON)	1053	1870	μA	I <sub>F</sub> =4mA, V <sub>CE</sub> =3.5V
6-1	Ic(ON)	650	1274	μA	I <sub>F</sub> =4mA, V <sub>CE</sub> =3.5V
6-2	Ic(ON)	465	750	μA	I <sub>F</sub> =4mA, V <sub>CE</sub> =3.5V
7-1	Ic(ON)	347	550	μA	I <sub>F</sub> =4mA, V <sub>CE</sub> =3.5V
7-2	Ic(ON)	306	441	μA	I <sub>F</sub> =4mA, V <sub>CE</sub> =3.5V
7-3	Ic(ON)	265	358	μA	I <sub>F</sub> =4mA, V <sub>CE</sub> =3.5V

**Thin Rank**

Color Code	Ranks	Symbol	Min	Max	Unit	Test Condition
Yellow	E3	Ic(ON)	286	431	μA	I <sub>F</sub> =4mA, V <sub>CE</sub> =3.5V
Silver	E4	Ic(ON)	357	519	μA	I <sub>F</sub> =4mA, V <sub>CE</sub> =3.5V
Green	E5	Ic(ON)	428	608	μA	I <sub>F</sub> =4mA, V <sub>CE</sub> =3.5V
Purple	E6	Ic(ON)	500	696	μA	I <sub>F</sub> =4mA, V <sub>CE</sub> =3.5V
White	E7	Ic(ON)	571	784	μA	I <sub>F</sub> =4mA, V <sub>CE</sub> =3.5V
Brown	E8	Ic(ON)	643	872	μA	I <sub>F</sub> =4mA, V <sub>CE</sub> =3.5V
Orange	E9	Ic(ON)	714	960	μA	I <sub>F</sub> =4mA, V <sub>CE</sub> =3.5V

**Typical Electro-Optical Characteristics Curves**

Fig.1 Forward Current vs. Ambient Temperature

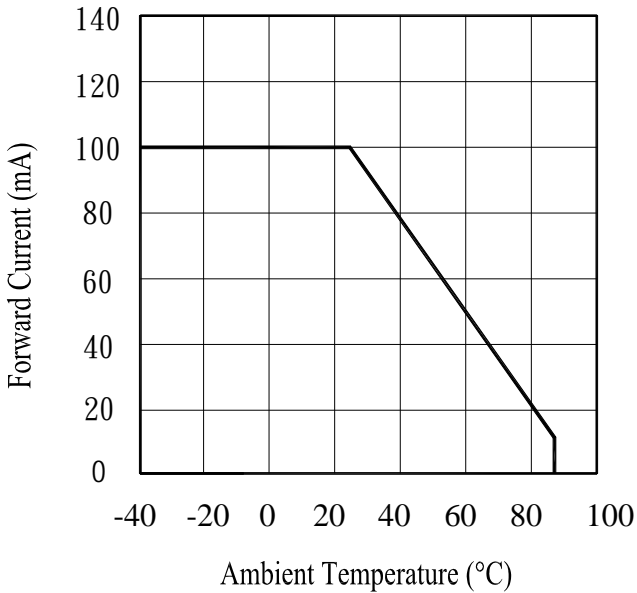

Fig.2 Spectral Distribution

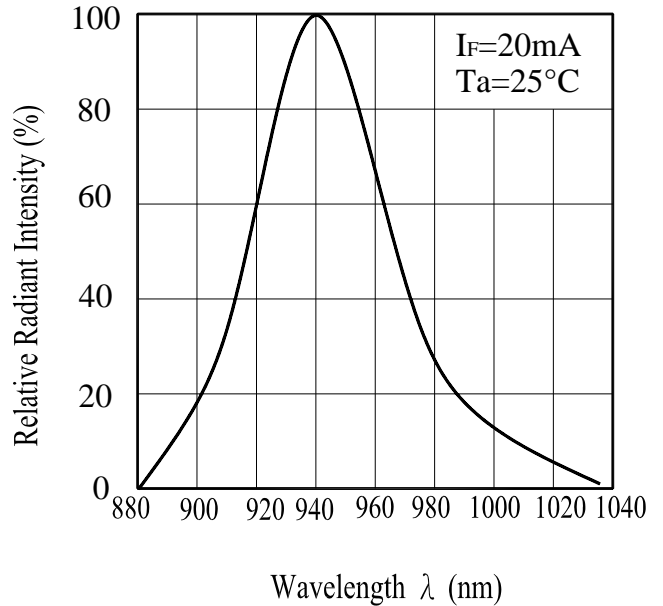

Fig.3 Peak Emission Wavelength vs. Ambient Temperature

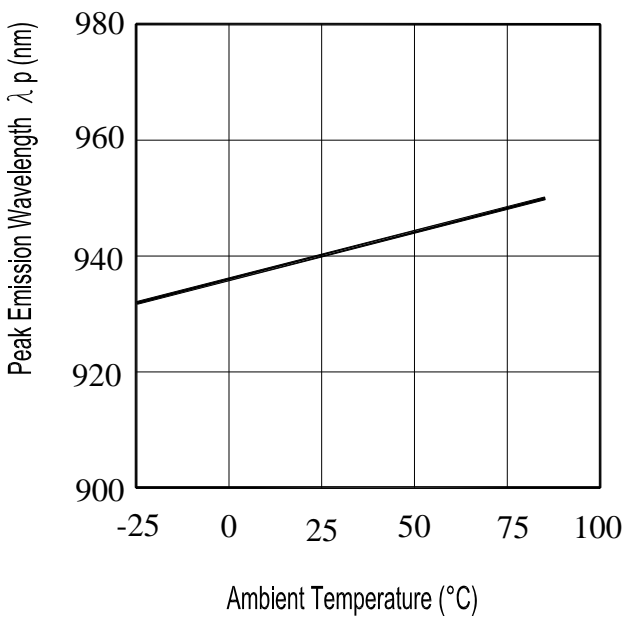
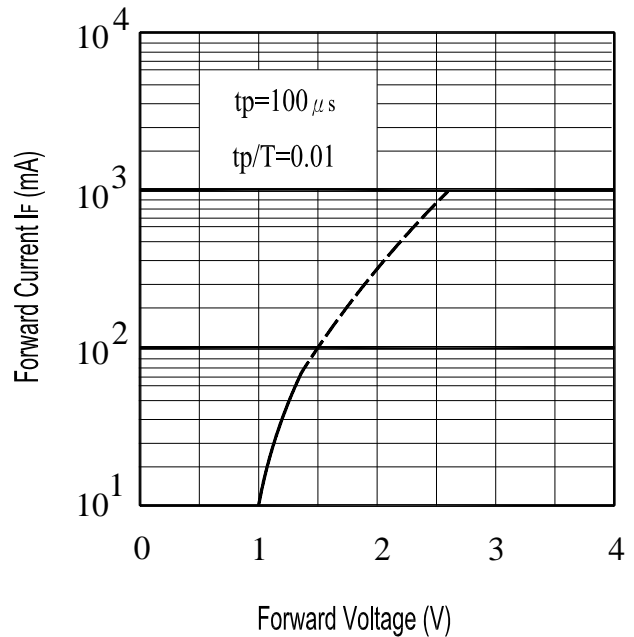

Fig.4 Forward Current vs. Forward Voltage



**Typical Electro-Optical Characteristics Curves**

Fig.5 Forward Voltage vs. Ambient Temperature

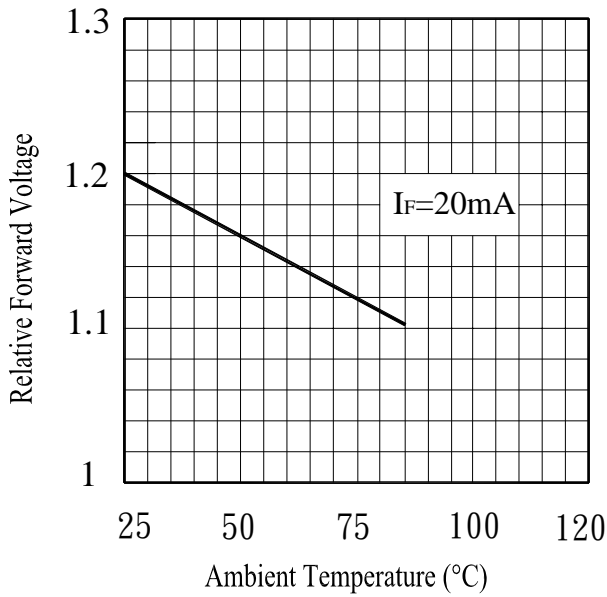
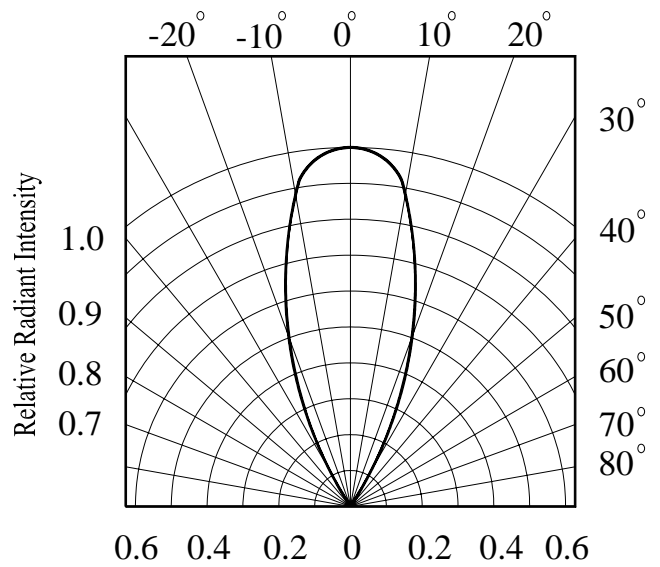

Fig.6 Relative Radiant Intensity vs. Angular Displacement



■ **Test Method For  $I_{C(ON)}$ :**

Condition:  $I_F=4mA, V_{CE}=3.5V$

The intensity testing method for infrared emitting diode

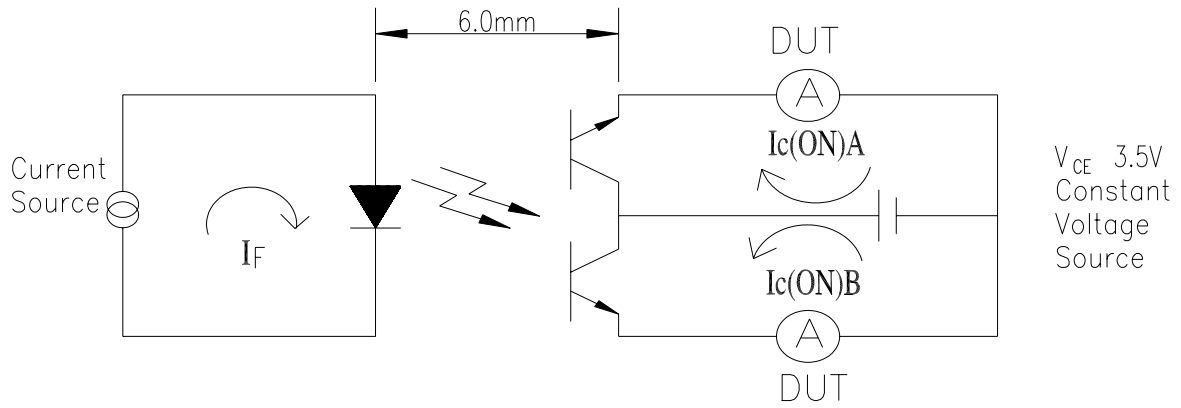







# Mouser Electronics

Authorized Distributor

Click to View Pricing, Inventory, Delivery & Lifecycle Information:

[Everlight:](#)

[IR928-6C-F](#)