



Document Name	Document No.	Date	Page
CR14250BL Specification	ZJQM-RD-SPC-H0470	2019-4-23	1/9

EEMB BATTERY
Lithium Manganese Dioxide Battery
Specification
锂离子电池
产品规格书
High Capacity Type

Model 型号:	CR14250BL
Capacity 容量:	900mAh

Prepared 编制	Checked 审核	Approved 批准
		

Customer 客户名称:

Customer Approval (Customer confirmation) 客户确认:

Address: 6/F, Block 110, Jindi Industrial Zone, Sha Tou Street, Futian District, Shenzhen, China

Postal code: 518048

Phone: +86-755-83022275

FAX: +86-755-83021966

<http://www.eemb.com>

Document Name	Document No.	Date	Page
CR14250BL Specification	ZJQM-RD-SPC-H0470	2019-4-23	2/9

Battery Structure 电池结构

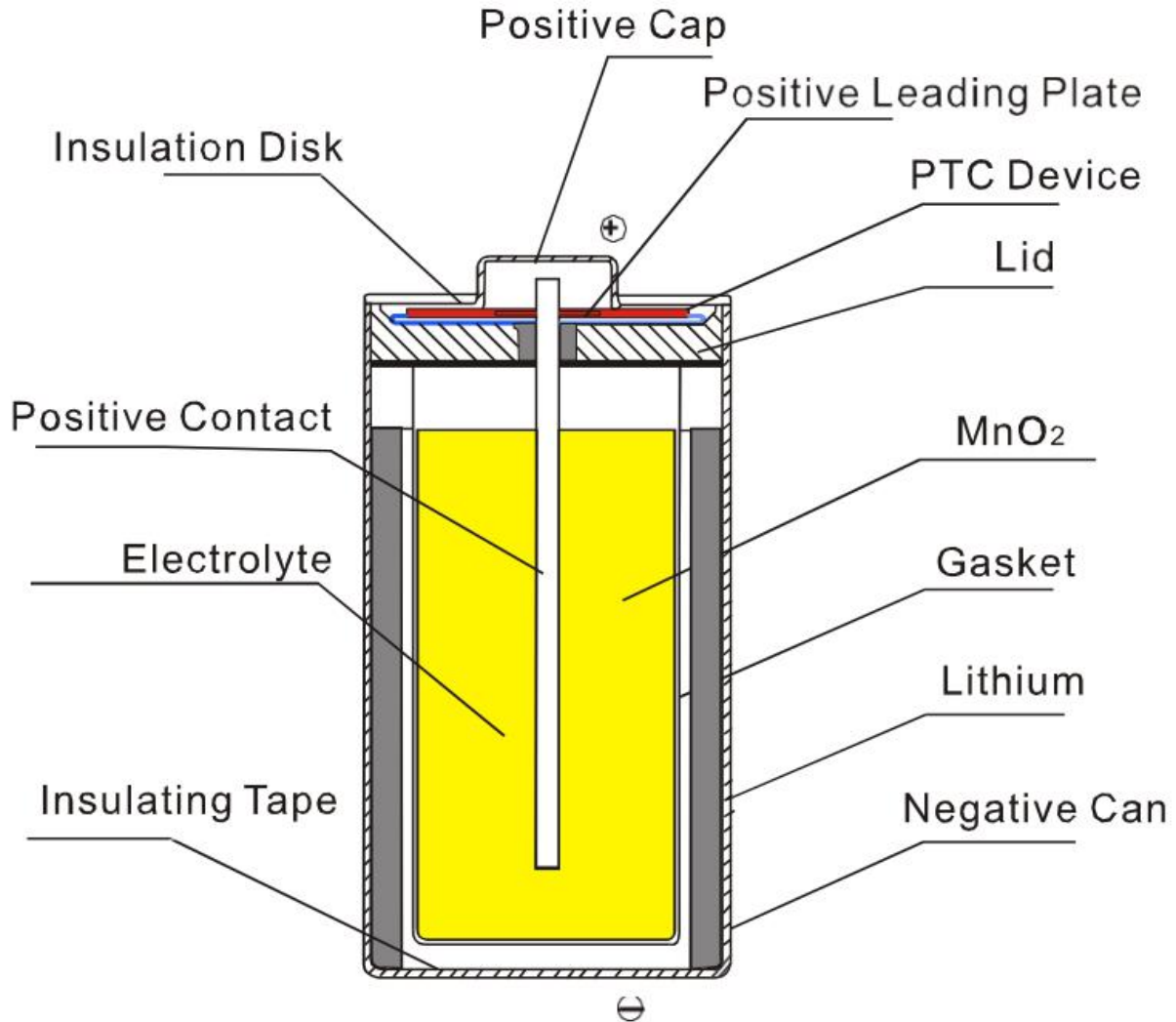

Catalog

Chapter	Content	Page
0	Catalog.....	2
1	Scope.....	4
2	Features and Applications.....	4
3	Battery Basic Characteristics.....	4
4	Dimension.....	5
5	Appearance.....	5
6	Performance and Test Methods.....	5-6
7	Characteristics Curve.....	6-7
8	Memory Backup Circuit Design Suggestion.....	7
9	Warranty.....	7
10	Matters Needing Attention.....	8-9

Document Name	Document No.	Date	Page
CR14250BL Specification	ZJQM-RD-SPC-H0470	2019-4-23	3/9

1. Scope 适用范围

This product specification defines the requirements of the Lithium Manganese Dioxide battery supplied to the customer by EEMB Co., Ltd.

本产品规格书适用于 EEMB 提供的锂二氧化锰电池。

2. Features and Applications 特性及应用

Features 特性:

- High energy density. 能量密度高
- Outstanding operational temperature range: -40°C to +85°C. 工作温度范围大 -40°C to +85°C
- Stable discharge characteristics. 放电性能稳定
- Low self-discharge: less than 2% per year at room temperature. 低自放率: 室温下每年小于 2%
- Superior shelf life and operational life: up to 10 years. 超长使用寿命: 长达 10 年
- Safe and environmentally friendly. 安全环保

Applications 应用:

- Water, gas and electricity meters 水、气、电测试表
- Alarm system, GPS system, GSM system, Medical devices 报警系统、GPS 系统、GSM 系统、医疗器械

3. Battery Basic Characteristics 电池基本特性

No.	Item 项目	Characteristics 特性
3.1	Model 型号	CR14250BL
3.2	Nominal Capacity 标称容量	900mAh
3.3	Nominal Voltage 标称电压	3.0V
3.4	Standard Discharge Current 标准放电电流	0.5mA
3.5	Max. Continuous Discharge Current 最大持续放电电流	7mA
3.6	Max. Pulse Discharge Current 最大脉冲放电电流	70mA
3.7	Weight 重量	Approx 约. 11g
3.8	Operating Temperature 工作温度	-40~85°C
3.9	Storage Condition 贮存条件	Temperature 温度 ≤ 30°C

Document Name	Document No.	Date	Page
CR14250BL Specification	ZJQM-RD-SPC-H0470	2019-4-23	4/9

4. Dimension 尺寸 (Unit 单位: mm)

Item 项目	Specification 规格
D	Max. 14.5
H	Max. 25.6
d	Max. 6.3

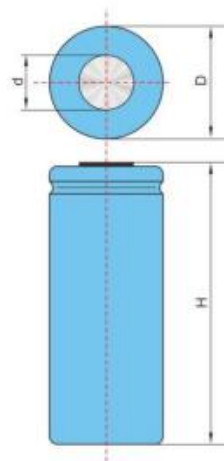

5. Appearance 外观

It shall be free from any defects such as remarkable scratches, breaks, cracks, discoloration, leakage, or middle deformation.

电池表面无划伤、裂纹、脏点、锈蚀、变形、变色、漏液等缺陷，中间无翘起。

6. Performance and Test Methods 性能测试

Test condition: Temperature 20°C~25°C; Humidity 65±20%.

测试条件：温度 20°C~25°C；相对湿度 65±20%。

No.	Item 项目	Standard 标准	Test Methods 测试方法
6.1	Compression test 压缩测试	No electrolyte loss, no rupturing. 无电解质损失，无破裂。	Press the cell with 1120kg. 以 1120kg 重压电芯。
6.2	Short circuit 短路	No electrolyte loss, no rupturing. 无电解质损失，无破裂。	Short circuit for 24 hrs with 0.1Ω. 用 0.1Ω短路 24 小时。
6.3	High temperature 高温	No fire, no explosion. 不起火，不爆炸。	Store at 150°C for 2 hours. 在 150°C 下储存 2 小时。
6.4	Puncture test 穿刺测试	No electrolyte loss, no rupturing. 无电解质损失，无破裂。	Total penetration of the cell by a nail φ3mm. 电池的总穿透量为φ3mm。
6.5	Vibration test 震动测试	No damage, leakage, no fire or explosion. 无损坏，泄漏，无火灾或爆炸。	Amplitude at frequency range: 5 to 55Hz: ±0.75mm; Frequency Range: 5Hz, 55Hz, 500Hz, 55Hz, 5Hz; Acceleration at frequency range: 55Hz to 500Hz: 100m/s

Document Name	Document No.	Date	Page
CR14250BL Specification	ZJQM-RD-SPC-H0470	2019-4-23	5/9

Cycle duration: 15min;
 Oscillation time of each main axis: 3h.
 频率范围振幅: 5 to 55Hz: $\pm 0.75\text{mm}$;
 频率范围: 5Hz, 55Hz, 500Hz, 55Hz, 5Hz;
 频率范围加速度: 55Hz to 500Hz: 100m/s;
 循环时间: 15min;
 每个主轴的振荡时间: 3 小时。

7. Characteristics Curve 特性曲线

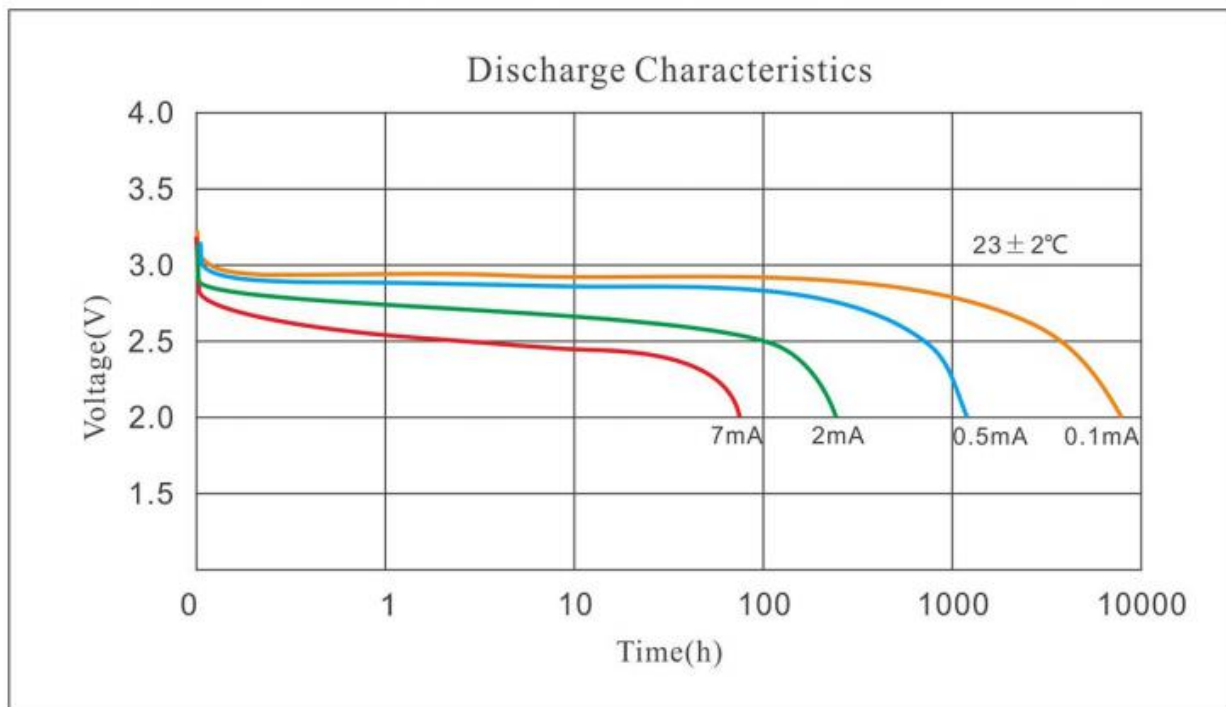

Document Name	Document No.	Date	Page
CR14250BL Specification	ZJQM-RD-SPC-H0470	2019-4-23	6/9

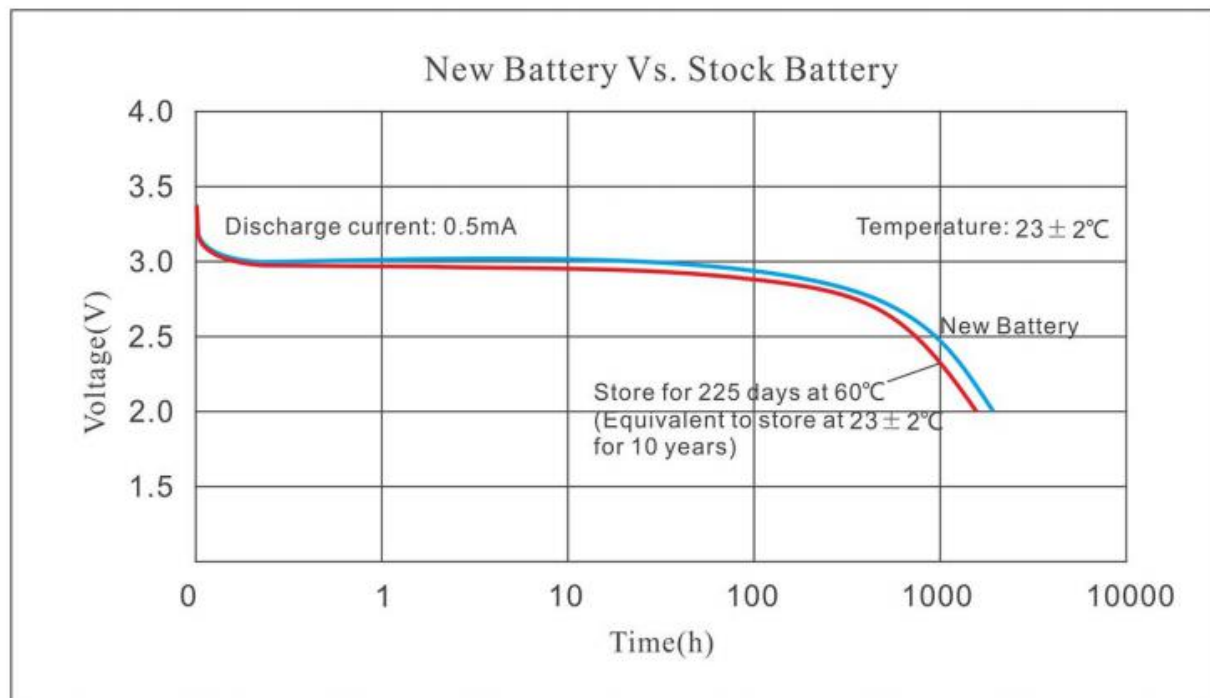
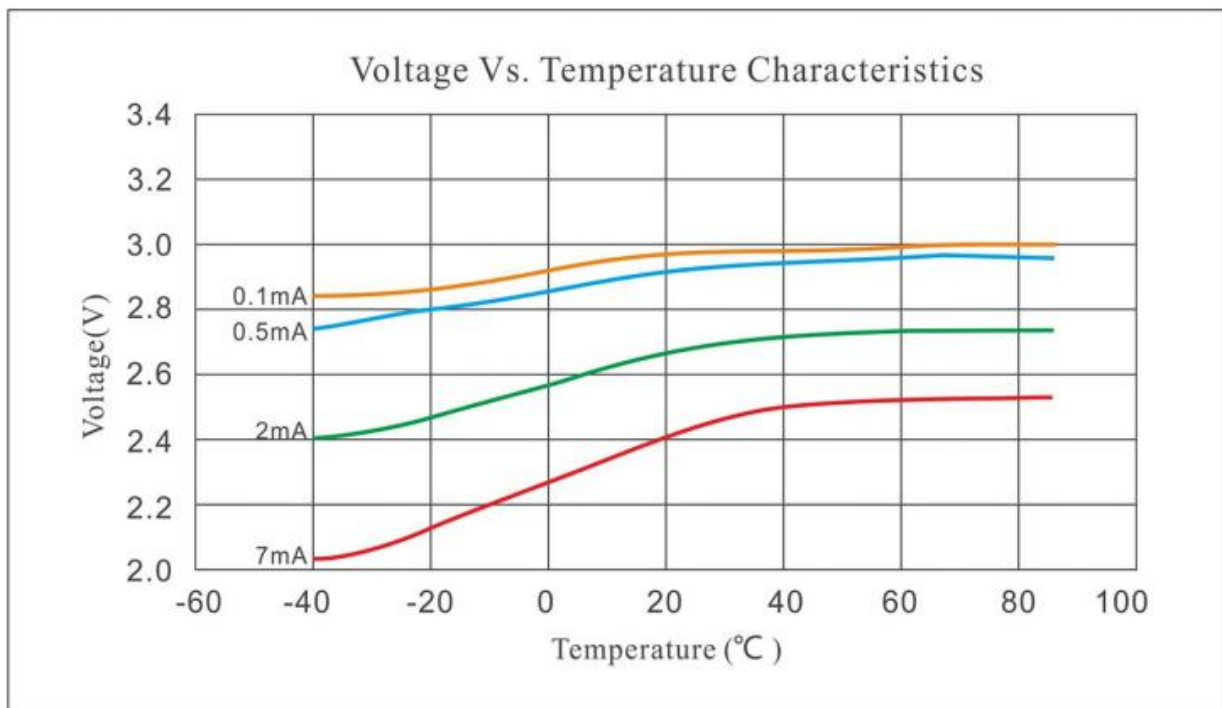

8. Memory Backup Circuit Design Suggestion 记忆备份电路设计建议

A primary lithium battery is not rechargeable, when used for memory backup in combination with another power source; current may flow into the battery from the other source. A protection diode and resistor into the circuit is needed to avoid battery charging or over discharging. Select a silicon diode or a diode with minimum leakage current, and design the circuit so that the amount of charging due to leakage current will not exceed 2% of the nominal battery capacity over the total period of use.

While used for memory backup, the following circuit shall be applied:

当与另一电源共同用于记忆备份电路时，一次锂电池是不可充的；电流可能会从另一个电源流入此电池

Document Name	Document No.	Date	Page
CR14250BL Specification	ZJQM-RD-SPC-H0470	2019-4-23	7/9

中。需在电路中加入保护二极管和电阻，以防电池进行充电或过放。选择硅材料或泄漏电流小的二极管设计电路，这样能保证在整个使用过程中，由泄露电路产生的充电量不会超过电池标称容量的 2%。当本电池用于记忆备份电路时，应采用如下电路：

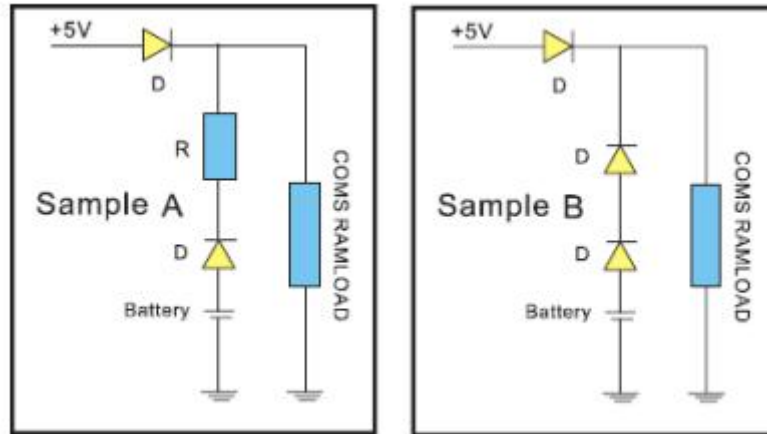

9. Warranty 保质期

6 months warranty for sample battery after date of production. One year warranty for finished battery after the date of production.

样品电池保质期为（出厂之日起）半年；产品电池保质期为（出厂之日起）1年。

10. Matters Needing Attention 注意事项

Strictly observe the following matters needing attention. EEMB will not be responsible for any accident occurred by handling outside of the precautions in this specification.

您必须严格遵守下述电池使用注意事项。对于没有按照以下注意事项所造成的任何意外事故，EEMB 不负任何责任。

! Caution 注意

- ✓ Use Nickel-plated iron or Nickel-plated stainless steel for the terminals that contact the battery.
- ✓ 使用镀镍铁或镀镍不锈钢的端子与电池接触。
- ✓ Make sure that terminal contact pressure is 50g minimum, for a stable contact.
- ✓ 确保电池端接触压力最小为 50g，以保证稳定接触。
- ✓ Keep the battery and contact terminal surfaces clean and free from moisture and foreign matter.
- ✓ 保持电池和接触端表面清洁、无水分或异物。
- ✓ Before inserting the battery, check the battery contact terminals to make sure they are normal, not bent or damaged. (Bent terminals may not make good contact with the battery or may cause short circuit.)
- ✓ 在安装前，检查电池端子，确保其正常、无弯折或损坏。（弯的端子可能造成接触不良或短路）
- ✓ When the batteries are piled up in a disorderly way, their positive and negative terminals may short-circuit, consuming some batteries while charging others, causing explosion.
- ✓ 当电池无序堆放时，正负极端子可能会发生短路、电池间的充放电、甚至造成爆炸。
- ✓ Lithium batteries that are almost exhausted can output a voltage that is almost the same as that of a new battery. Please does not judge a battery only with a Voltmeter. Do not mix batteries of different types and

Document Name	Document No.	Date	Page
CR14250BL Specification	ZJQM-RD-SPC-H0470	2019-4-23	8/9

brands, or new and used batteries. We are well informed that battery pack should be assembled with single batteries of similar voltage, capacity and inner resistance.

- ✓ 电量即将用尽的锂电池释放出的电压几乎与新电池一样：请不要仅依据电压示数判断电池的新旧程度。请勿将不同类型或品牌的电池混合使用。
- ✓ Lithium batteries need a period of time to recover their normal voltage after even a slight short circuit. Therefore, if the battery is short-circuited, wait an adequate long time for batteries to recover before measuring their electrical characteristics.
- ✓ 锂电池在发生轻微短路后，需要一段时间才能恢复正常电压。因此，如果电池被短路，请先等待电池恢复原电压，再对其参数进行测量。
- ✓ Use a high impedance (1M or higher) voltmeter to measure battery voltage.
- ✓ 请使用高电阻(1M 或以上)测量电池电压。
- ✓ Add fuse between negative and connector. Once short circuit, it will cut immediately and permanently.
- ✓ 请在负极和插头之间加入熔丝。一旦发生短路，熔丝会立即、永久切断电路。
- ✓ Do not contact terminals with conductive i.e. metal, goods. Keep batteries in non-conductive, i.e. plastic, trays.
- ✓ 请不要用金属等导电物体接触电池正负极。将电池置于塑料等不导电的物体周围。
- ✓ Reduce impact to insulation layer from vibration, but the dimension will enlarge.
- ✓ 减少震动对电池绝缘层的冲击，否则电池尺寸将会扩大。
- ✓ Battery characteristics vary with type and grade, even when batteries are the same size and shape. When replacing batteries with new ones, be sure to carefully check the symbols and numbers on them.
- ✓ 电池性能随类型和等级的变化而有所不同，甚至同一尺寸和形状的电池，性能也不相同。当用新电池替换旧电池时，请认真核对电池上的标志和参数。

! Danger 危险

- ✓ DO NOT recharge, short-circuit, disassemble, deform, heat or place the battery near a direct flame. This battery contains flammable materials such as lithium and organic solvent and performing any of the above actions could cause it to ignite explode or become damaged.
- ✓ 请勿对电池进行充电、短路、拆解、或使电池变形；请勿加热或置于明火附近。电池内含有锂、有机溶剂等易燃材料，上述任何操作都可能导致电池损坏甚至发生爆炸。
- ✓ DO NOT over-discharge the battery. In case the battery is over-discharged when connected with exterior power source or connected with other batteries in series, explosion may occur.
- ✓ 请勿对电池进行过放电。电池与外部电源链接或与其他电池串联可能会引起爆炸。
- ✓ Keep this battery out of the reach of children. If it is swallowed, contact a physician immediately.
- ✓ 请将电池远离儿童。若发生吞咽，请立即就医。
- ✓ When storing a battery or throwing it away, be sure to cover it with tape. If the battery is contacted with other metal objects, it could cause fire or become damaged.
- ✓ 当贮存或丢弃电池时，请务必对电池进行包裹处理。若电池与其他金属物品接触可能造成电池损坏或引发火灾。

! Warning 警告

- ✓ Thoroughly read the user's manual before use, inaccurate handling may cause leakage, heat, smoke, explosion, or fire, causing device trouble or injury.
- ✓ 在使用之前请仔细阅读操作说明书，不适当的操作可能引起电池变热、着火、爆炸、毁坏或电池容



Document Name	Document No.	Date	Page
CR14250BL Specification	ZJQM-RD-SPC-H0470	2019-4-23	9/9

量的衰减。

- ✓ Insert the battery with the "+" and "-" ends correctly oriented.
- ✓ 在装入设备时注意电池的正负极不要反装。
- ✓ If the battery is used together with new batteries, do not use it with a different type battery.
- ✓ 禁止把电池同干电池或其它原电池或者新旧电池一起使用，也不要同不同包装、不同型号或不同品牌的电池一起使用。
- ✓ Do not solder the battery directly. Protect the welding point and connector.
- ✓ 禁止直接对电池进行焊接。对焊点和插头做好保护措施。
- ✓ The battery should be preferably stored in dry and cool conditions. Avoid storing the battery in direct sunlight, or in excessively hot and humid place. Storage at high temperature must be avoided to preserve the battery life time.
- ✓ 电池应贮存在通风干燥处。请勿将点出贮存在阳光直射下或高温高湿环境中。为保持电池使用寿命，请避免在高温中贮存电池。

EEMB reserves the final explanation. Please use battery strictly according to specification. EEMB will not be responsible for any inappropriate operation. EEMB keeps the right to change product specifications without previous notice. If any question, please consult with the manufacturer.

EEMB 保留最终解释权。请严格按照规范使用电池。EEMB 对任何不当操作将不负责。EEMB 保留修改产品规格书不另行通知的权利。如有任何问题,请咨询制造商。