

# VISIBLE LIGHT PRODUCTS SPECIFICATION

## HPR20D-19K10xWHBx



High Power 10W LED

Drawn by	Checked by	Approved by



DATE:2011/11/14

REV:D



**HUEY JANN ELECTRONICS INDUSTRY CO., LTD.**

No.27 Line 466 Sec.2,Cannng-nan Rd. Wu-chi Town Taichung Shien, Taiwan, R.O.C.

TEL:+886-4-26393976 FAX:+886-4-26393125

HUEY JANN High Power 10W LED is made of hi-eff AS/TS GaInN chips with precise package technique which makes excellent heat dissipation to reach the advantages of high luminous efficiency, low decay, and long endurance. Now we have these colors available: red, green, blue, white, yellow .

☰ **FEATERUS**

- Instant light
- Long operating life
- Superior ESD defense
- Low voltage DC operated
- More energy efficient than incandescent and most halogen lamps

☰ **TYPICAL APPLICATIONS**

- Architectural detail lighting
- Portable flashlight
- Reading lights
- Medical applications
- LCD backlights
- Beacon lights
- Decoration lights



**HUEY JANN ELECTRONICS INDUSTRY CO., LTD.**

No.27 Line 466 Sec.2,Cannng-nan Rd. Wu-chi Town Taichung Shien, Taiwan, R.O.C.

TEL:+886-4-26393976 FAX:+886-4-26393125

Explanation of Part Number:

H P R 20 D - 1 9K 10 xWHBx  
① ② ③ ④ ⑤ ⑥ ⑦ ⑧ ⑨

1.H: Huey Jann

2.P: High power LED Type

3.Shape distinguish:

4.Identification no:

R: Reflector type

5.Lead frame type

6.Lens appearance:

1:White Diffusion

7.Color number:

8.Power type:

3K: Green

4K: Yellow

10: 10W

5K: Red

8K: Blue

20: 20W

9K: White

9.Color kind:

BWHB: Cool White

WHB: Pure White

NWHB: Nature White

YWHB: Warm White



**HUEY JANN ELECTRONICS INDUSTRY CO., LTD.**

No.27 Line 466 Sec.2,Cannng-nan Rd. Wu-chi Town Taichung Shien, Taiwan, R.O.C.

TEL:+886-4-26393976 FAX:+886-4-26393125

PACKAGE DIMENSIONS:

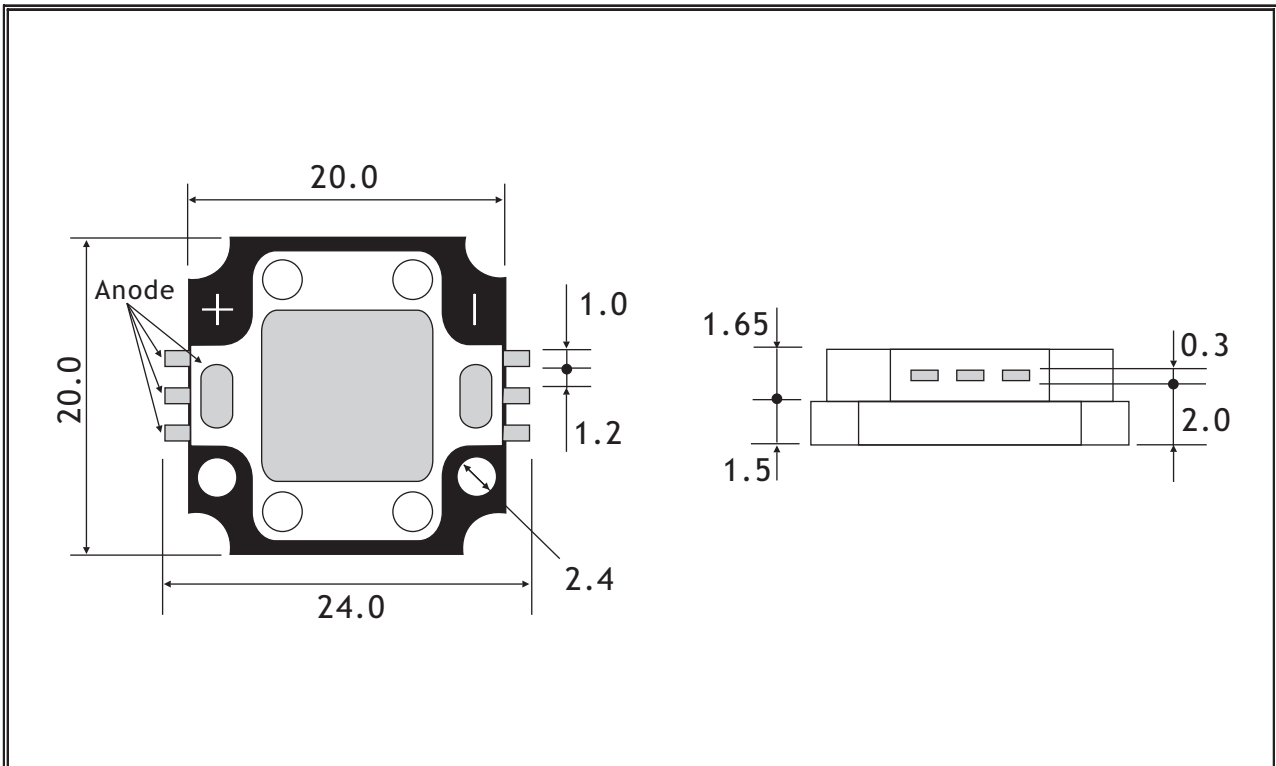

NOTE:

- 1.All dimensions are in millimeter.
- 2.Lead spacing in measured where the lead emerge from the package.
- 3.prodruded resin under flange is 1.5mm max.
- 4.specifications are subject to change without notice.
- 5.Tolerance is 0.3mm unless otherwise noted.
- 6.Driving LED without heat sinking device is forbidden.
- 7.It is strongly recommended that the temperature of lead be not higher than 55°C.
- 8.Proper current derating must be observed to maintain junction temperature below the maximum.
- 9.LEDs are not designed to be driven in reserve bias.
10. Warps the degree 0.5mm.



**HUEY JANN ELECTRONICS INDUSTRY CO., LTD.**

No.27 Line 466 Sec.2,Cannng-nan Rd. Wu-chi Town Taichung Shien, Taiwan, R.O.C.

TEL:+886-4-26393976 FAX:+886-4-26393125

☰ DEVICES

Item	Lens Color	Dice Source	Color Temperature Typ (°K)
HPR20D-19K10BWHB	Yellow Diffusion	GaN/GaN	8000
HPR20D-19K10WHB			6000
HPR20D-19K10NWHB			4000
HPR20D-19K10NWHB/CRI 90			
HPR20D-19K10YWHB			3300
HPR20D-19K10YWHB/CRI 90			



**HUEY JANN ELECTRONICS INDUSTRY CO., LTD.**

No.27 Line 466 Sec.2,Canng-nan Rd. Wu-chi Town Taichung Shien, Taiwan, R.O.C.

TEL:+886-4-26393976 FAX:+886-4-26393125

**ABSOLUTE MAXIMUM RATINGS**

TA=25°C

PARAMETER	SYMBOL	MAX. RATING	UNIT
Continuous Forward Current	IF	700	mA
Peak Forward Current *1	IFM	1000	mA
Electrostatic Discharge (HBM)	ESD	4000	V
LED Junction Temperature	Tj	135	°C
Operating Temperature	Topr	-40 ~ +110	°C
Storage Temperature	Tstg	-40 ~ +120	°C
Manual Soldering Temperature 260 °C for 5 seconds max. *2			

\*1.Duty Ratio=0.1%,Pulse Width=10us.

\*2.Iron soldering high temperature will not cause damage to the dice. But be aware of the high temperature will not only make the epoxy soften but also cause the lead moving and the gold wire broken and even open. So before returning to the normal temperatures PLEASE AVOID any serious pressure on the top of epoxy and lead.

\*3. We suggest using PWM (Pulse Width Modulation) for driving.

\*4. It is recommended to use series as there are several 3pcs. If there are more than 5pcs, please use product with higher power.



**HUEY JANN ELECTRONICS INDUSTRY CO., LTD.**

No.27 Line 466 Sec.2,Cannng-nan Rd. Wu-chi Town Taichung Shien, Taiwan, R.O.C.

TEL:+886-4-26393976 FAX:+886-4-26393125

**ELECTRIC-OPTICAL CHARACTERISTICS**

TA=25°C

PARAMETER	SYMBOL	TEST CONDITION	MIN	TYP	MAX	UNIT
View Angle of Half Power	2θ1/2	IF=700mA		120		deg
Forward Voltage	VF			13	16	V
Thermal Resistance Junction To Case	$R\theta_{J-C}$			4		°C/W
Temperature Coefficient Of Forward Voltage	$\Delta V_F/\Delta T$			-2		mV/°C

**ELECTRIC-OPTICAL CHARACTERISTICS TO BE INDEPENDENT**

IF=700mA TA=25°C

Item	CCT (°K)	CRI (Ra)	Brightness (lm)
	Typical		
HPR20D-19K10BWHB	8000	75	1060
HPR20D-19K10WHB	6000		
HPR20D-19K10NWHB	4000	72	1005
HPR20D-19K10NWHB/CRI 90		90	825
HPR20D-19K10YWHB	3300	70	950
HPR20D-19K10YWHB/CRI 90		90	780



**HUEY JANN ELECTRONICS INDUSTRY CO., LTD.**

No.27 Line 466 Sec.2,Cannng-nan Rd. Wu-chi Town Taichung Shien, Taiwan, R.O.C.

TEL:+886-4-26393976 FAX:+886-4-26393125

RELIABILITY TEST

➤ Endurance Test

Test Item	Reference Standard	Test Conditions	Result
Operation Life	MIL-STD-750:1026 MIL-STD-883:1005 JIS-C-7021 :B-1	Connect with a power if=700mA Ta=Under room temperature Test Time=1,000hrs	0/22
High Temperature High Humidity Storage	MIL-STD-202:103B JIS-C-7021 :B-11	Ta=+85°C 5°C RH=80% ~ 85% Test Time=1,000hrs	0/22
High Temperature Storage	MIL-STD-883:1008 JIS-C-7021 :B-10	High Ta=+120°C 5°C Test Time=1,000hrs	0/22
Low Temperature Storage	JIS-C-7021 :B-12	Low Ta=-40°C 5°C Test Time=1,000hrs	0/22

\*Failure Criteria:

1. VF arise  $\geq$  10%
2. IV decline  $\geq$  30%
3. A failure is an LED that is open or shorted



**HUEY JANN ELECTRONICS INDUSTRY CO., LTD.**

No.27 Line 466 Sec.2,Cannng-nan Rd. Wu-chi Town Taichung Shien, Taiwan, R.O.C.

TEL:+886-4-26393976 FAX:+886-4-26393125



RELIABILITY TEST

➤ Environmental Test

Test Item	Reference Standard	Test Conditions	Result
Temperature Cycling	MIL-STD-202:107D MIL-STD-750:1051 MIL-STD-883:1010 JIS-C-7021 :A-4	-40°C ~ +25°C ~ +85°C ~ +25°C 60min 20min 60min 20min Test Time=200cycle	0/22
Thermal Shock	MIL-STD-202:107D MIL-STD-750:1051 MIL-STD-883:1010	-40°C 5°C ~ +110°C 5°C 20min 20min Test Time=200cycle	0/22

\*Failure Criteria:

1. VF arise  $\geq$  10%
2. IV decline  $\geq$  30%
3. A failure is an LED that is open or shorted



**HUEY JANN ELECTRONICS INDUSTRY CO., LTD.**

No.27 Line 466 Sec.2,Cannng-nan Rd. Wu-chi Town Taichung Shien, Taiwan, R.O.C.

TEL:+886-4-26393976 FAX:+886-4-26393125

TYPICAL ELECTRICAL OPTICAL CHARACTERISTICS CURVES

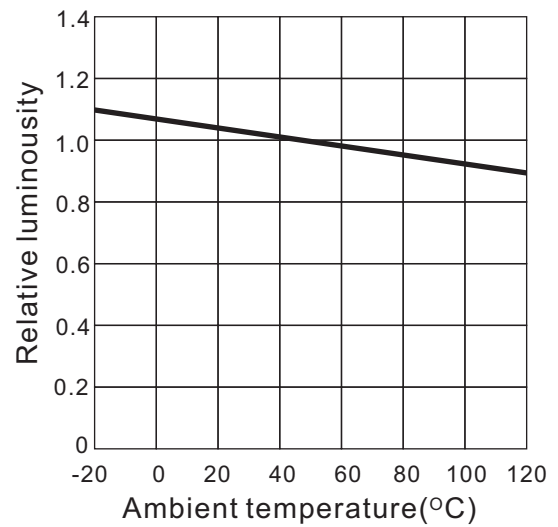
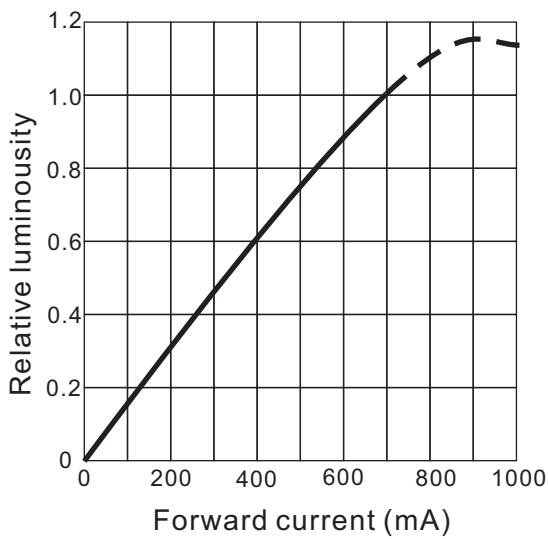
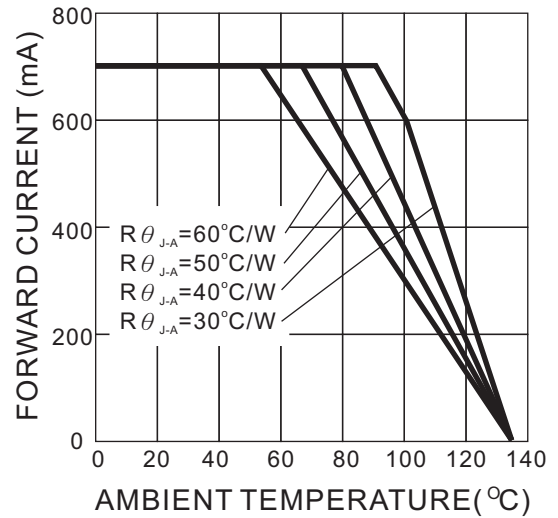
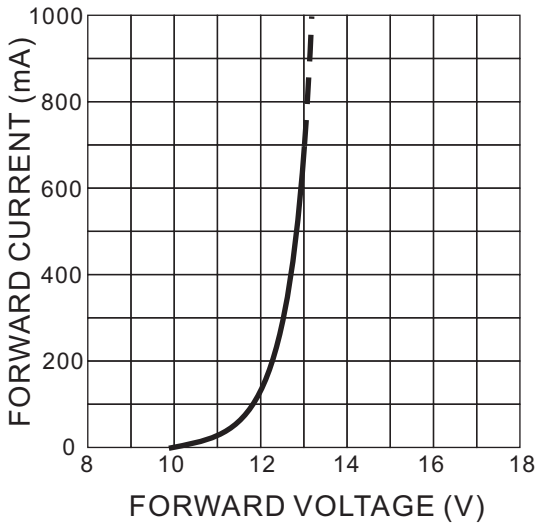

**HUEY JANN ELECTRONICS INDUSTRY CO., LTD.**

No.27 Line 466 Sec.2,Cannng-nan Rd. Wu-chi Town Taichung Shien, Taiwan, R.O.C.

TEL:+886-4-26393976 FAX:+886-4-26393125

TYPICAL ELECTRICAL OPTICAL CHARACTERISTICS CURVES

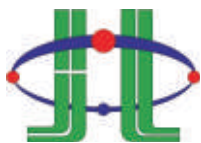
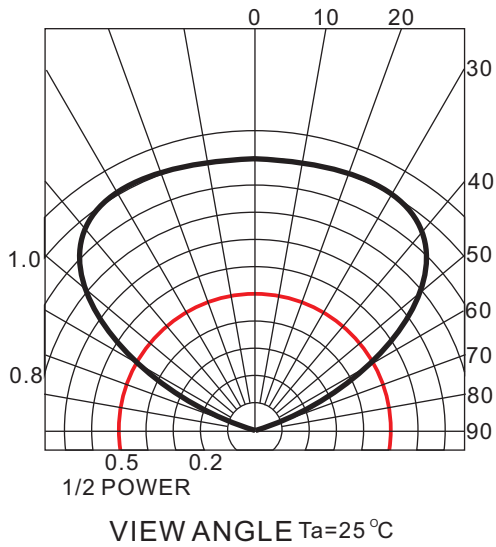
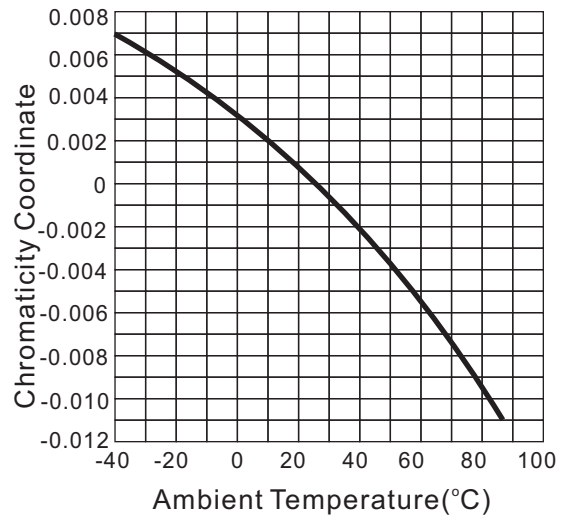
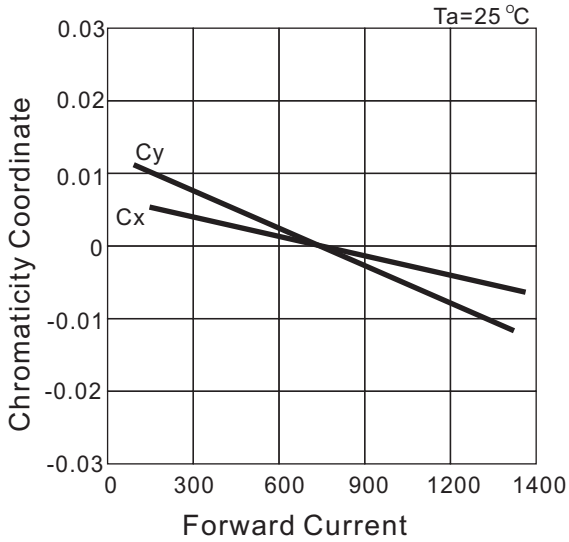

**HUEY JANN ELECTRONICS INDUSTRY CO., LTD.**

No.27 Line 466 Sec.2,Canng-nan Rd. Wu-chi Town Taichung Shien, Taiwan, R.O.C.

TEL:+886-4-26393976 FAX:+886-4-26393125

TYPICAL ELECTRICAL OPTICAL CHARACTERISTICS CURVES

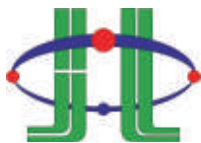
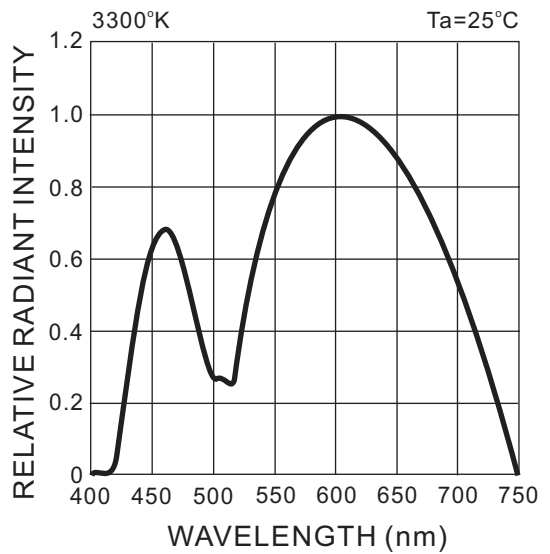
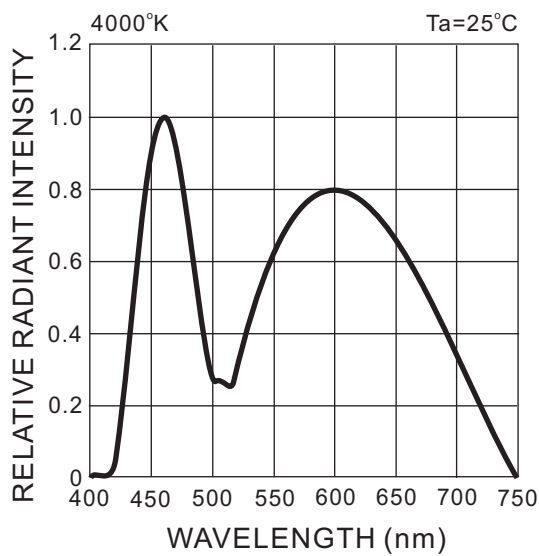
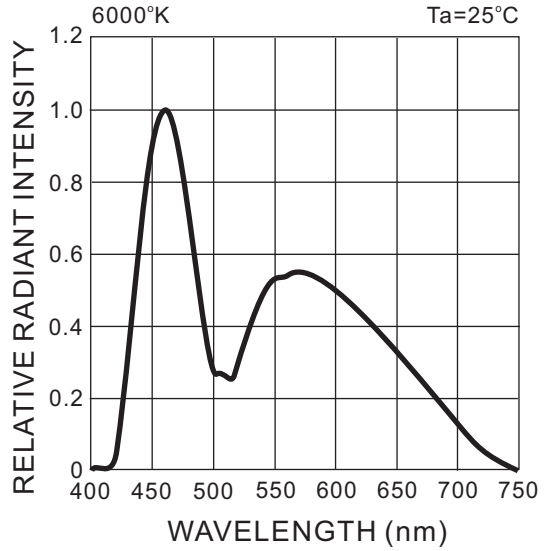
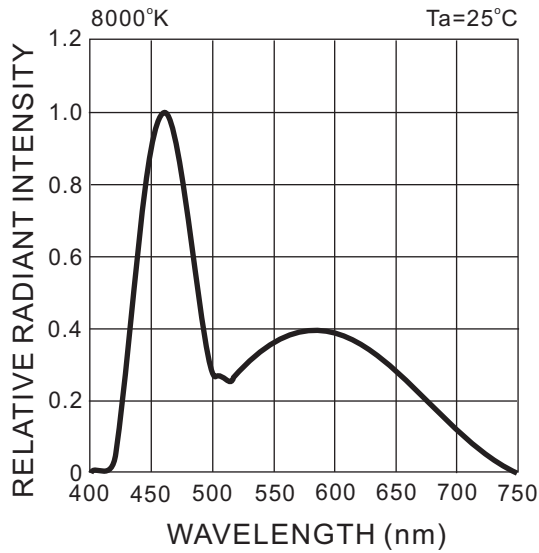

**HUEY JANN ELECTRONICS INDUSTRY CO., LTD.**

No.27 Line 466 Sec.2,Canng-nan Rd. Wu-chi Town Taichung Shien, Taiwan, R.O.C.

TEL:+886-4-26393976 FAX:+886-4-26393125

☰ Cool White Color Bin Selection

CCT(°K)	Chromaticity Coordinates				
TYP					
8000	x	0.274	0.303	0.311	0.290
	y	0.301	0.333	0.293	0.270

☰ Cool White CIE Light Color Chart

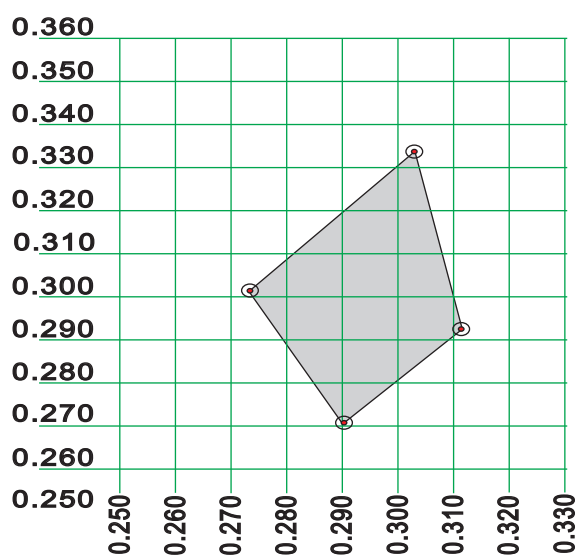

**HUEY JANN ELECTRONICS INDUSTRY CO., LTD.**

No.27 Line 466 Sec.2,Canng-nan Rd. Wu-chi Town Taichung Shien, Taiwan, R.O.C.

TEL:+886-4-26393976 FAX:+886-4-26393125

Pure White Color Bin Selection

CCT(°K)	Chromaticity Coordinates				
TYP					
6000	x	0.301	0.329	0.329	0.311
	y	0.342	0.369	0.310	0.293

Pure White CIE Light Color Chart

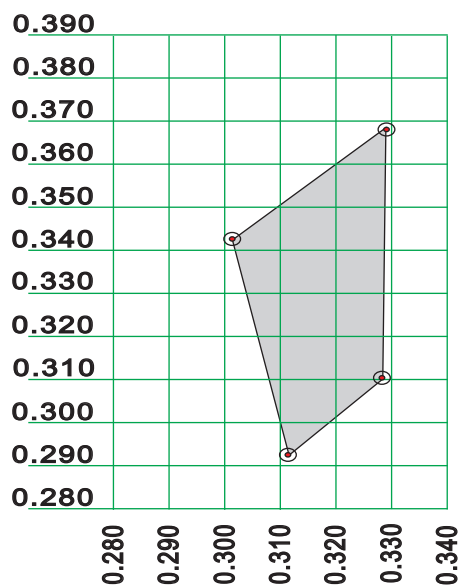

**HUEY JANN ELECTRONICS INDUSTRY CO., LTD.**

No.27 Line 466 Sec.2,Canng-nan Rd. Wu-chi Town Taichung Shien, Taiwan, R.O.C.

TEL:+886-4-26393976 FAX:+886-4-26393125

☰ Nature White Color Bin Selection

CCT(°K)	Chromaticity Coordinates				
TYP					
4000	x	0.367	0.420	0.396	0.357
	y	0.400	0.432	0.367	0.342

☰ Nature White CIE Light Color Chart

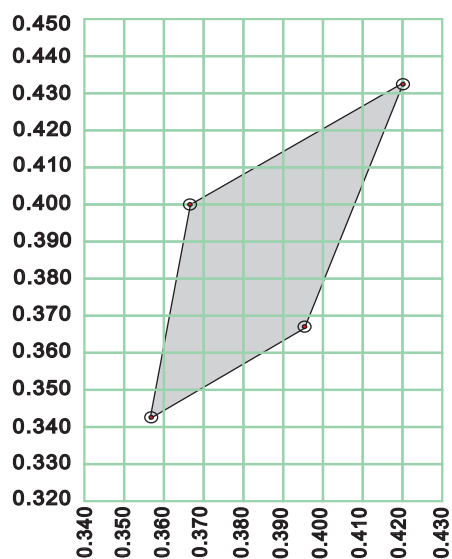

**HUEY JANN ELECTRONICS INDUSTRY CO., LTD.**

No.27 Line 466 Sec.2,Canng-nan Rd. Wu-chi Town Taichung Shien, Taiwan, R.O.C.

TEL:+886-4-26393976 FAX:+886-4-26393125

Warm White Color Bin Selection

CCT (K)	Chromaticity Coordinates						
TYP							
3300	x	0.402	0.454	0.429	0.416	0.410	0.383
	y	0.423	0.446	0.394	0.389	0.374	0.360

Warm White CIE Light Color Chart

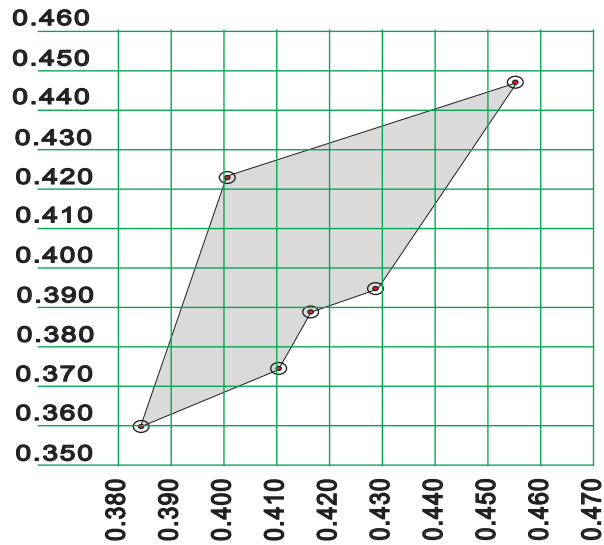

**HUEY JANN ELECTRONICS INDUSTRY CO., LTD.**

No.27 Line 466 Sec.2,Canng-nan Rd. Wu-chi Town Taichung Shien, Taiwan, R.O.C.

TEL:+886-4-26393976 FAX:+886-4-26393125



10W Thermal conductive glue spreading instruction

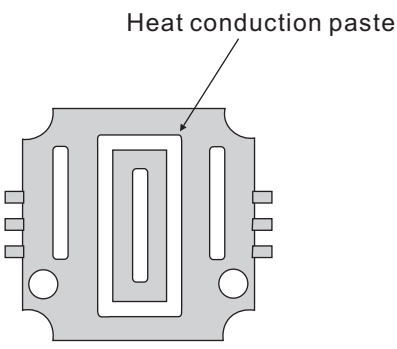

Heat conduction paste

1. Spread thermal conductive glue evenly on the bottom of LED.於 LED.

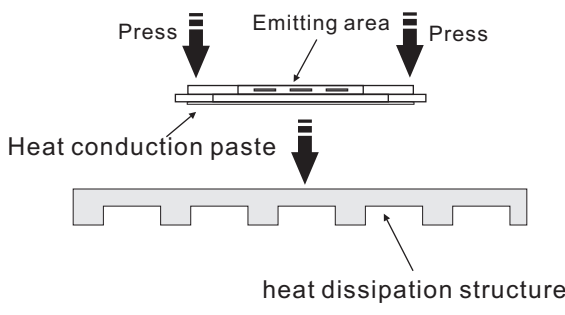

Press

Press

Emitting area

Heat conduction paste

heat dissipation structure

2. Press LED down to conjunct to second heat sink firmly; but please avoid pressure and touch on emitting area(lens).

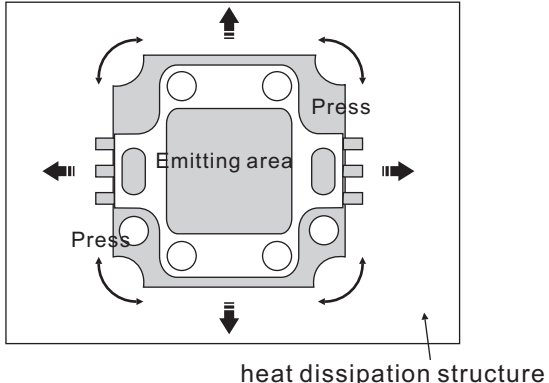

Press

Press

Emitting area

heat dissipation structure

3. Keep pressing; squeeze the air in-between LED and heat sink out and fill up the gap by rotating and slightly moving on all sides.



**HUEY JANN ELECTRONICS INDUSTRY CO., LTD.**

No.27 Line 466 Sec.2,Cannng-nan Rd. Wu-chi Town Taichung Shien, Taiwan, R.O.C.

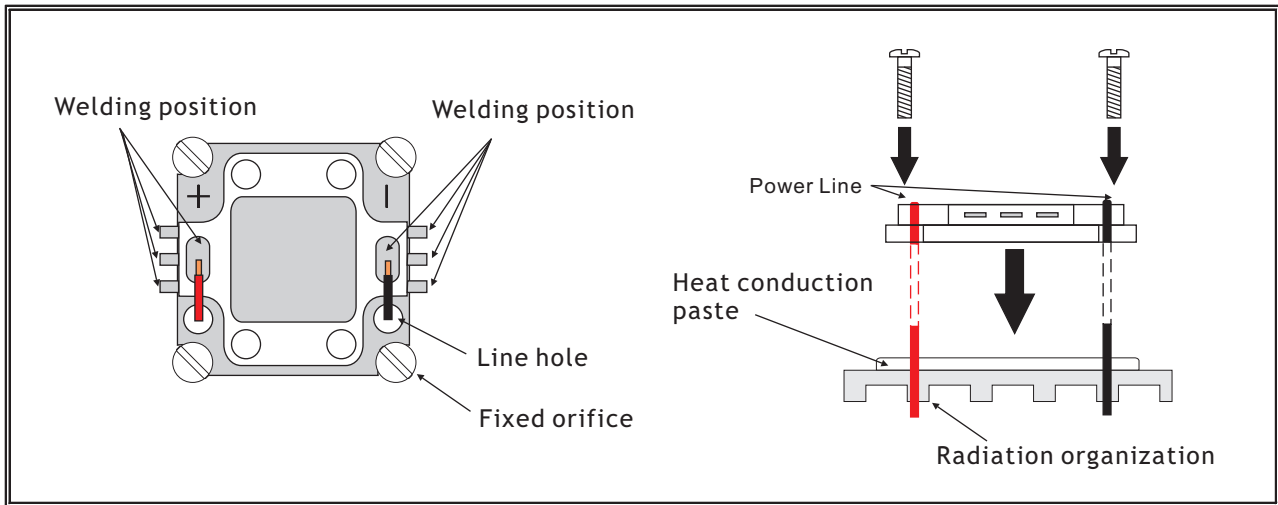

TEL:+886-4-26393976 FAX:+886-4-26393125

**POSITION EXPLANATION:**



**Conclusion**

Huey Jann provide simple comparison table for High Power LED, you could find your request heat dissipation area from the following table.

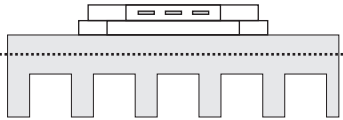
			
	Free Convection Horizontal Flat Heat Dissipation-Set-up ( Area Require mm <sup>2</sup> )	Free Convection Vertical Flat Heat Dissipation-Set-up ( Area Require mm <sup>2</sup> )	Free Convection Finned Heat Dissipation-Set-up ( Area Require mm <sup>2</sup> )
10W	13,500	10,000	46,500

\*TAB in this table is according to highest operating temperature 65°C.

\*Different materials of second heat dissipation device, the surface area of heat sink will be different. Thus, this document is for reference only.



**HUEY JANN ELECTRONICS INDUSTRY CO., LTD.**

No.27 Line 466 Sec.2,Cannng-nan Rd. Wu-chi Town Taichung Shien, Taiwan, R.O.C.

TEL:+886-4-26393976 FAX:+886-4-26393125

PRODUCT APPLICATION

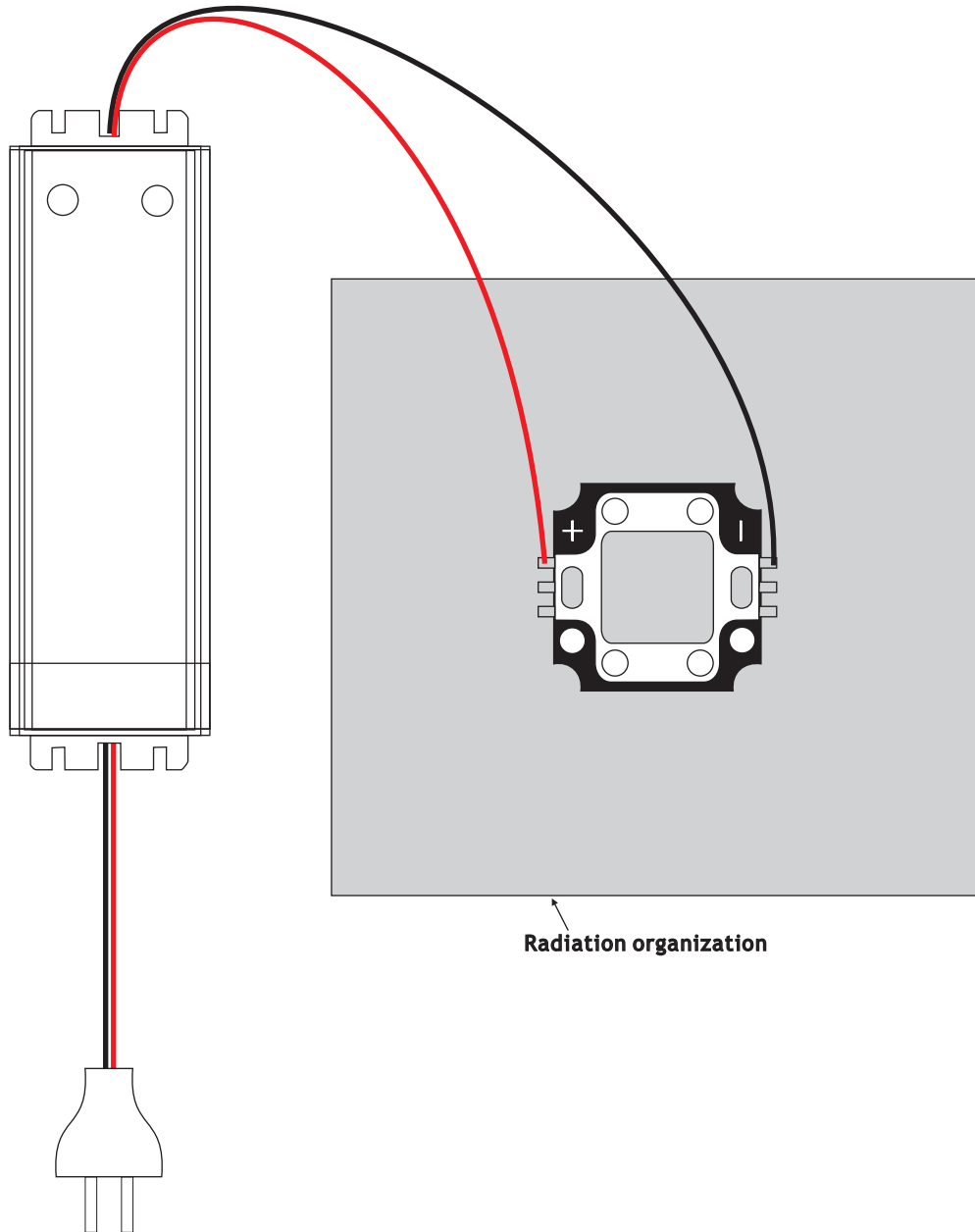

**HUEY JANN ELECTRONICS INDUSTRY CO., LTD.**

No.27 Line 466 Sec.2,Cannng-nan Rd. Wu-chi Town Taichung Shien, Taiwan, R.O.C.

TEL:+886-4-26393976 FAX:+886-4-26393125

10W Operating Instructions

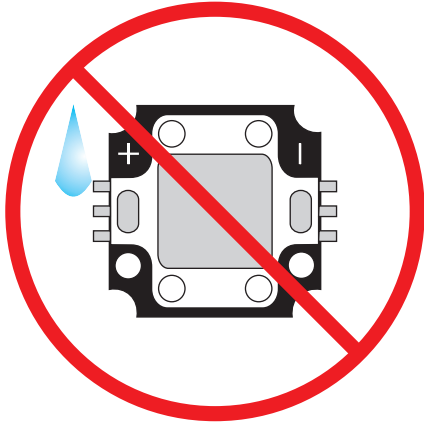

1. It is important to keep away the product from water, in order to avoid the product's electronic characteristics becoming harmful.

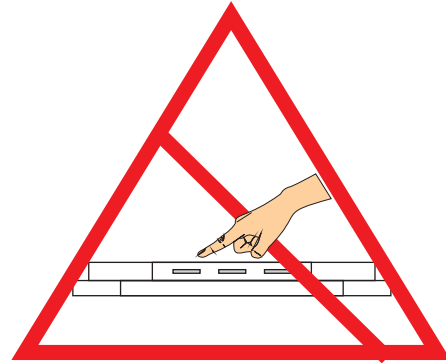

2. When making use of products, it is necessary to use anti-ESD devices to prevent destructive electronic characteristics.

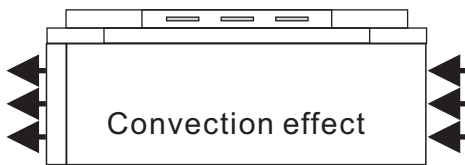

3. It should be noticed whether there is convection in the design of the device. Convection must exist.

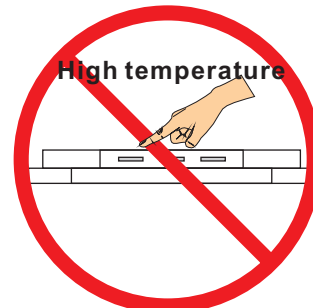

Above 150°C



4. There is 150°C directly from the front of the 10W emitting diode. It is untouchable to prevent burning.



**HUEY JANN ELECTRONICS INDUSTRY CO., LTD.**

No.27 Line 466 Sec.2, Cangg-nan Rd. Wu-chi Town Taichung Shien, Taiwan, R.O.C.

TEL:+886-4-26393976 FAX:+886-4-26393125

10W Operating Instructions

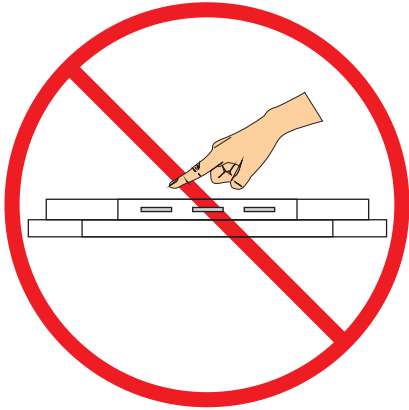

5. The material in the central top of 10W LED is soft. Therefore, it is un-squeezable and un-touchable.

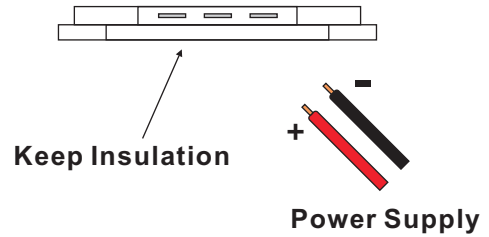

6. In the bottom of heat sink cannot be touched with neither positive nor negative pole. (Heat sink has to be insulation.)

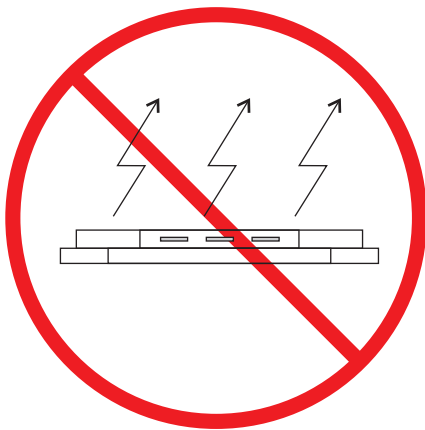

7. The product should not be light up directly without heat dissipation device.



**HUEY JANN ELECTRONICS INDUSTRY CO., LTD.**

No.27 Line 466 Sec.2,Canng-nan Rd. Wu-chi Town Taichung Shien, Taiwan, R.O.C.

TEL:+886-4-26393976 FAX:+886-4-26393125

TAB Temperature - Life Characteristics Curves

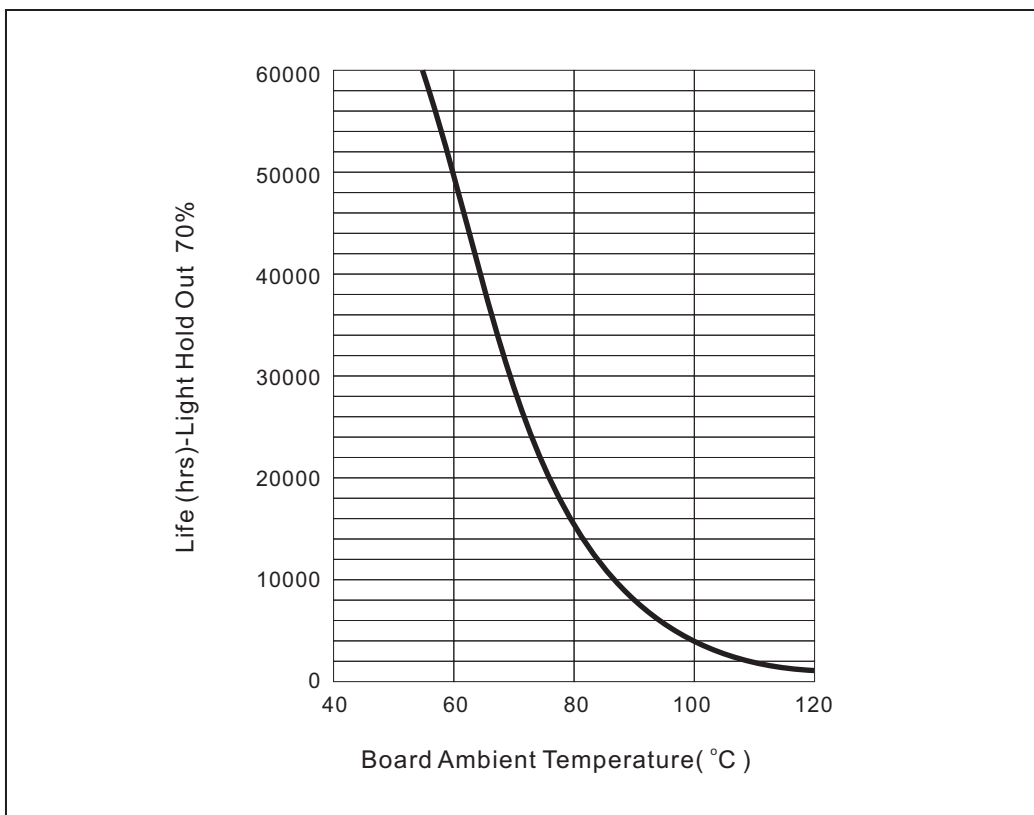
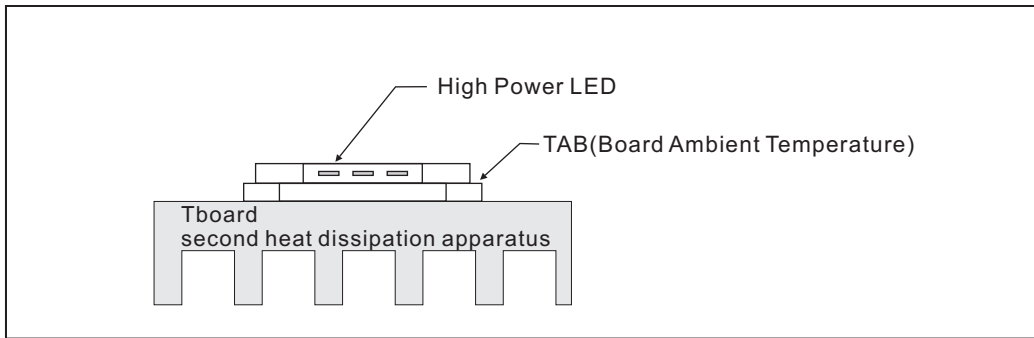

\*Board Ambient Temperature Tolerance 5°C.

\*TAB in this table is according to highest operating temperature 65°C.

\*The TAB is the stable testing value for the product lighted 100% after one hour.

\*Different materials of second heat dissipation device, the surface area of heat sink will be different. Thus, this document is for reference only.



**HUEY JANN ELECTRONICS INDUSTRY CO., LTD.**

No.27 Line 466 Sec.2,Cannng-nan Rd. Wu-chi Town Taichung Shien, Taiwan, R.O.C.

TEL:+886-4-26393976 FAX:+886-4-26393125

**Remarks:**

1. Brightness values are measured during a current pulse of typical 25 ms, the brightness tolerance is +/-15%.
2. Chromaticity coordinates are measured during a current pulse of typical 200 ms, the chromaticity tolerance is +/-0.015.
3. Forward voltage are measured during a current pulse of typical 5 ms, the VF tolerance is +/-0.15V.
4. Dimensions are specified as follows: mm.
5. Related technical parameters of LED are average value resulted from statistic. The actual parameters of LED could be slightly different from average and characteristic curve.
6. The average value of LED will be changed by technical improvement and elevation, and subject to change without prior notice.
7. Hi-Power LED can not be operated without second heat dissipating structure.
8. Poor or damaged second heat dissipating structure could lead to defective electrical characteristic of High Power LED, CCT escalation, brightness drop, lifetime shortening or burn out. Following instructions of Huey Jann Hi-Power LED series document can avoid LED burn out and electrical defectiveness due to improper usage, and maintain normal performance of the products.
9. Suggestion: Fix LED with screw on second heat sink, in order to attach LED firmly with it.
10. After drilling holes on second heat sink. Burr will occur easily. In order to avoid non-firmly connection between LED and second heat sink and affect LED life span, burr need to be trimmed prior to use.
11. Before fixing LED on second heat sink with screw, except for trimming burr, Thermal conductive glue or pad needs to be spread evenly on the bottom of LED. Please refer to "instruction for thermal conductive glue usage" in our datasheet for spread method.



**HUEY JANN ELECTRONICS INDUSTRY CO., LTD.**

No.27 Line 466 Sec.2,Cannng-nan Rd. Wu-chi Town Taichung Shien, Taiwan, R.O.C.

TEL:+886-4-26393976 FAX:+886-4-26393125