

IRG4PSH71U

INSULATED GATE BIPOLAR TRANSISTOR

UltraFast Speed IGBT

Features

- UltraFast switching speed optimized for operating frequencies 8 to 40kHz in hard switching, 200kHz in resonant mode soft switching
- Generation 4 IGBT design provides tighter parameter distribution and higher efficiency (minimum switching and conduction losses) than prior generations
- Industry-benchmark Super-247 package with higher power handling capability compared to same footprint TO-247
- Creepage distance increased to 5.35mm

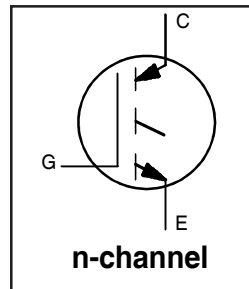

$V_{CES} = 1200V$
$V_{CE(on)} \text{ typ.} = 2.50V$
@ $V_{GE} = 15V, I_C = 50A$

Benefits

- Generation 4 IGBT's offer highest efficiencies available
- Maximum power density, twice the power handling of the TO-247, less space than TO-264
- IGBTs optimized for specific application conditions
- Cost and space saving in designs that require multiple, paralleled IGBTs

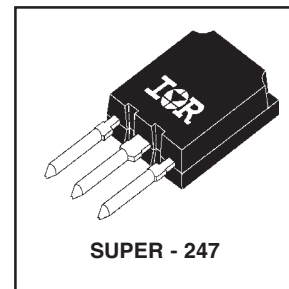

Absolute Maximum Ratings

	Parameter	Max.	Units
V_{CES}	Collector-to-Emitter Voltage	1200	V
$I_C @ T_C = 25^\circ C$	Continuous Collector Current	99	A
$I_C @ T_C = 100^\circ C$	Continuous Collector Current	50	
I_{CM}	Pulse Collector Current ①	200	
I_{LM}	Clamped Inductive Load current ②	200	
V_{GE}	Gate-to-Emitter Voltage	± 20	V
E_{ARV}	Reverse Voltage Avalanche Energy ③	150	mJ
$P_D @ T_C = 25^\circ C$	Maximum Power Dissipation	350	W
$P_D @ T_C = 100^\circ C$	Maximum Power Dissipation	140	
T_J	Operating Junction and	-55 to +150	°C
T_{STG}	Storage Temperature Range		
	Storage Temperature Range, for 10 sec.	300 (0.063 in. (1.6mm) from case)	

Thermal / Mechanical Characteristics

	Parameter	Min.	Typ.	Max.	Units
$R_{\theta JC}$	Junction-to-Case- IGBT	—	—	0.36	°C/W
$R_{\theta CS}$	Case-to-Sink, flat, greased surface	—	0.24	—	
$R_{\theta JA}$	Junction-to-Ambient, typical socket mount	—	—	38	
	Recommended Clip Force	20 (2.0)			N (kgf)
Wt	Weight	—	6 (0.21)	—	g (oz.)

Electrical Characteristics @ T_J = 25°C (unless otherwise specified)

Parameter	Min.	Typ.	Max.	Units	Conditions	
V _{(BR)CES}	1200	—	—	V	V _{GE} = 0V, I _C = 250μA	
V _{(BR)ECS}	19	—	—	V	V _{GE} = 0V, I _C = 1.0A	
ΔV _{(BR)CES} /ΔT _J	—	0.78	—	V/°C	V _{GE} = 0V, I _C = 1mA	
V _{CE(on)}	Collector-to-Emitter Saturation Voltage	—	2.52	2.70	V	I _C = 70A, V _{GE} = 15V I _C = 140A, V _{GE} = 15V I _C = 70A, T _J = 150°C See Fig.2, 5
		—	3.17	—		
		—	2.68	—		
V _{GE(th)}	3.0	—	6.0		V _{CE} = V _{GE} , I _C = 250μA	
ΔV _{GE(th)} /ΔT _J	—	-9.2	—	mV/°C	V _{CE} = V _{GE} , I _C = 1.0mA	
g _{fe}	48	72	—	S	V _{CE} = 100V, I _C = 70A	
I _{CES}	Zero Gate Voltage Collector Current	—	—	500	μA	V _{GE} = 0V, V _{CE} = 1200V
		—	—	2.0		V _{GE} = 0V, V _{CE} = 10V
		—	—	5000		V _{GE} = 0V, V _{CE} = 1200V, T _J = 150°C
I _{GES}	—	—	±100	nA	V _{GE} = ±20V	

Switching Characteristics @ T_J = 25°C (unless otherwise specified)

Parameter	Min.	Typ.	Max.	Units	Conditions
Q _g	—	370	560	nC	I _C = 70A V _{CC} = 400V V _{GE} = 15V See Fig.8
Q _{ge}	—	61	24		
Q _{gc}	—	120	50		
t _{d(on)}	—	51	—	ns	I _C = 70A, V _{CC} = 960V V _{GE} = 15V, R _G = 5.0Ω Energy losses include "tail" See Fig. 9, 10, 11, 14
t _r	—	70	—		
t _{d(off)}	—	280	390		
t _f	—	170	260		
E _{on}	—	4.77	—		
E _{off}	—	9.54	—	mJ	
E _{tot}	—	14.3	15.8		
t _{d(on)}	—	49	—	ns	T _J = 150°C, See Fig. 9, 10, 11, 14 I _C = 70A, V _{CC} = 960V V _{GE} = 15V, R _G = 5.0Ω Energy losses include "tail"
t _r	—	70	—		
t _{d(off)}	—	390	—		
t _f	—	360	—		
E _{TS}	—	25	—	mJ	
L _E	—	13	—	nH	Measured 5mm from package
C _{ies}	—	7280	—	pF	V _{GE} = 0V V _{CC} = 30V, See Fig.7 f = 1.0MHz
C _{oes}	—	290	—		
C _{res}	—	50	—		

Notes:

- ① Repetitive rating; V_{GE}=20V; pulse width limited by maximum junction temperature (figure 20)
- ② V_{CC}=80%(V_{CES}), V_{GE}=20V, L=10μH, R_G= 5.0 Ω (figure 13a)
- ③ Pulse width ≤ 80μs; duty factor ≤ 0.1%.
- ④ Pulse width 5.0μs, single shot.
- ⑤ Repetitive rating; pulse width limited by maximum junction temperature.

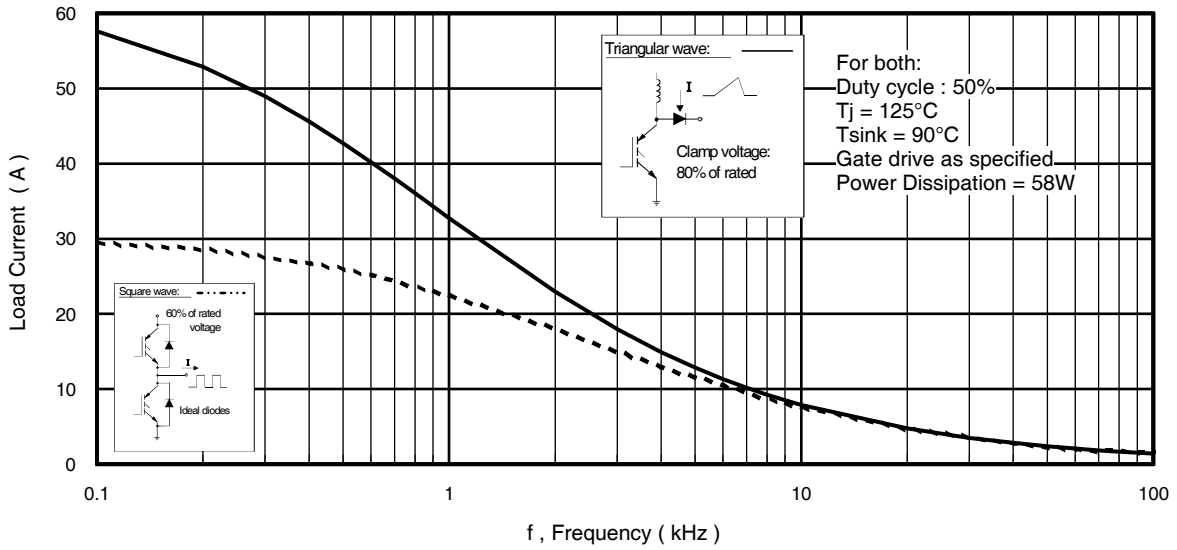

Fig. 1 - Typical Load Current vs. Frequency
(For square wave, $I = I_{\text{RMS}}$ of fundamental; for triangular wave, $I = I_{\text{PK}}$)

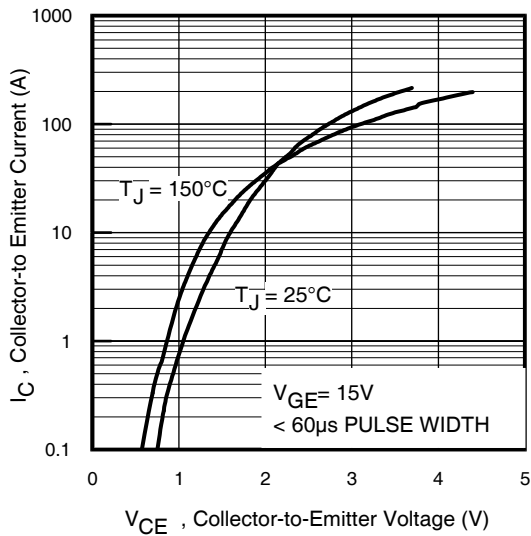

Fig. 2 - Typical Output Characteristics

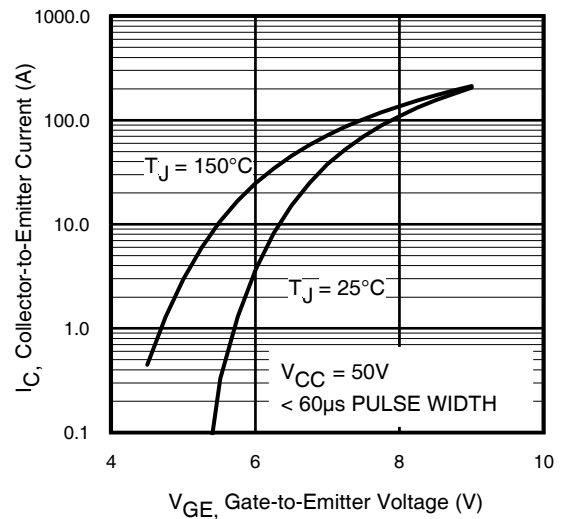

Fig. 3 - Typical Transfer Characteristics

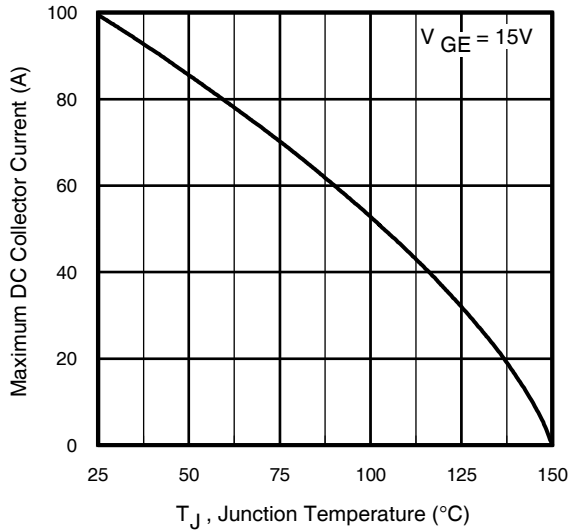

Fig. 4 - Maximum Collector Current vs. Case Temperature

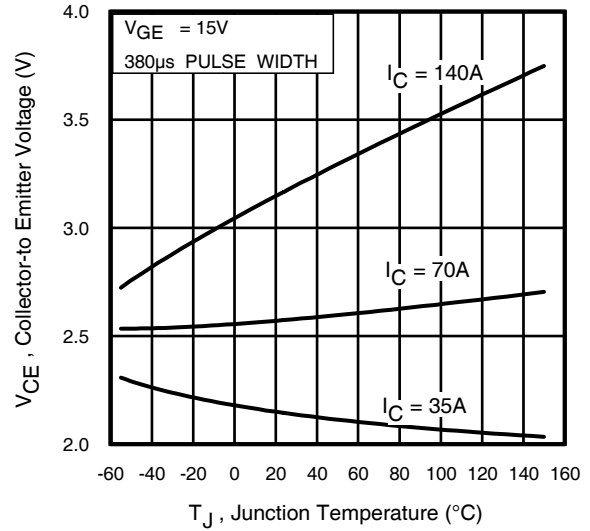

Fig. 5 - Collector-to-Emitter Voltage vs. Junction Temperature

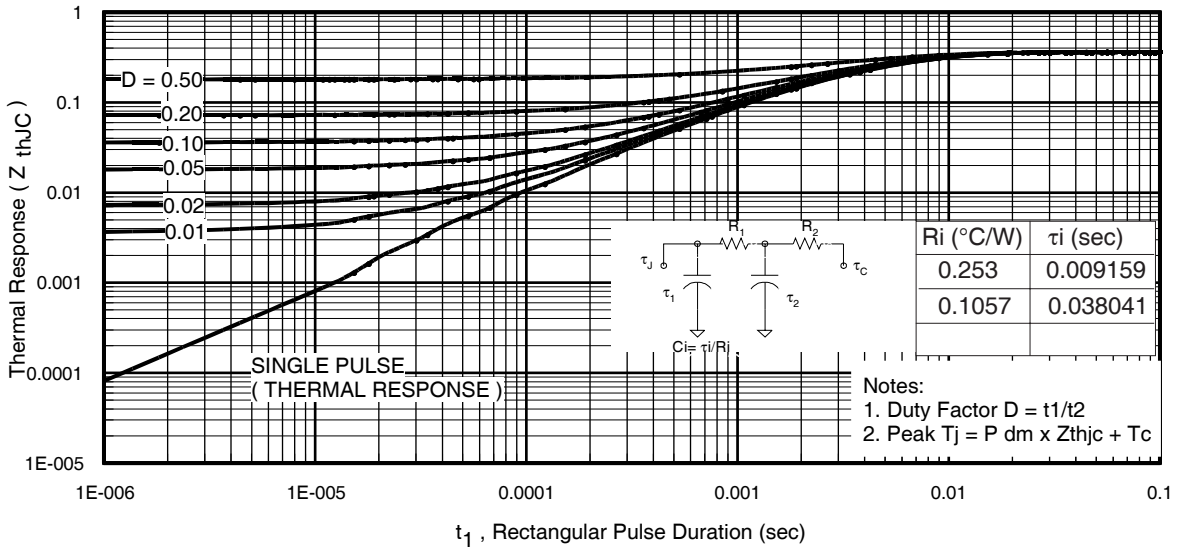

Fig. 6 - Maximum Effective Transient Thermal Impedance, Junction-to-Case

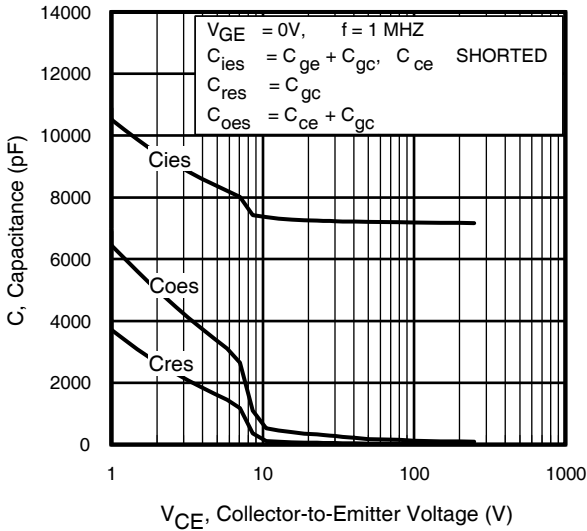

Fig. 7 - Typical Capacitance vs. Collector-to-Emitter Voltage

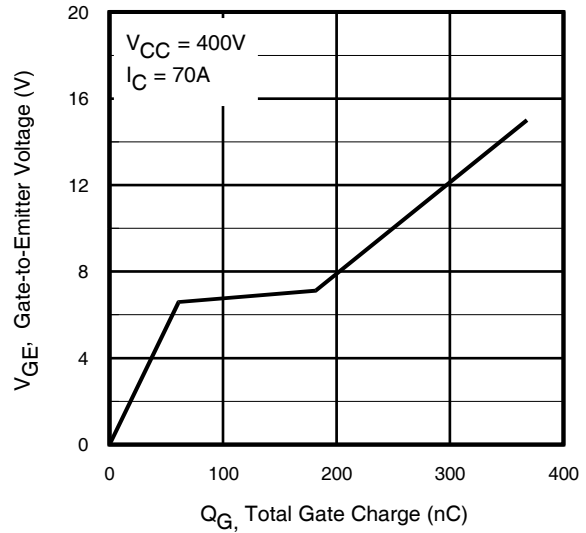

Fig. 8 - Typical Gate Charge vs. Gate-to-Emitter Voltage

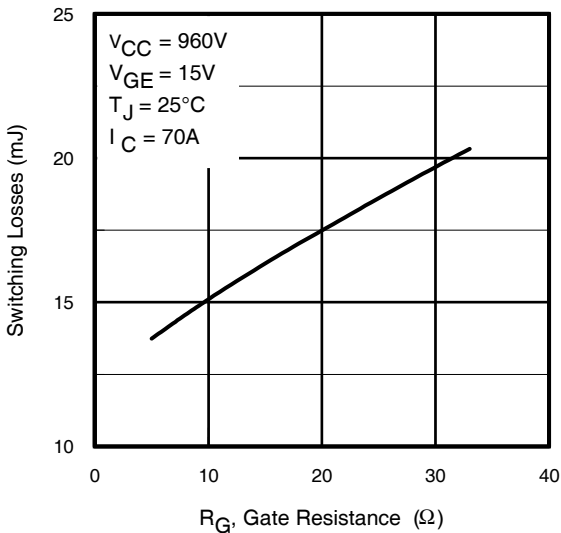

Fig. 9 - Typical Switching Losses vs. Gate Resistance

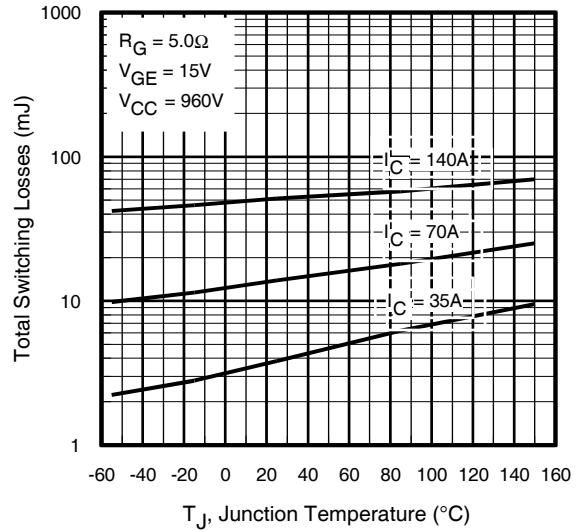

Fig. 10 - Typical Switching Losses vs. Junction Temperature

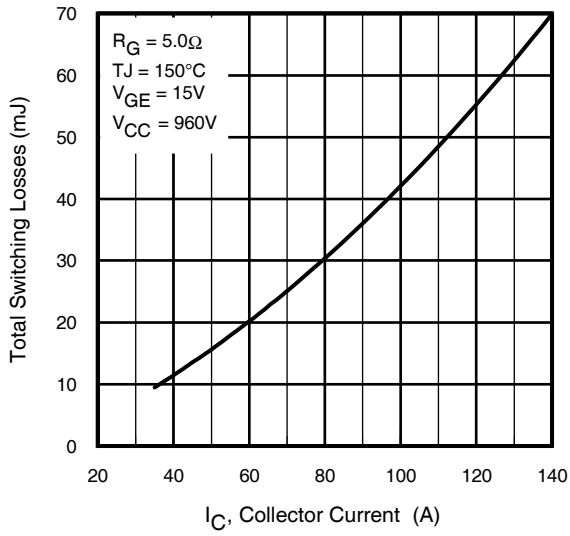

Fig. 11 - Typical Switching Losses vs. Collector-to-Emitter Current

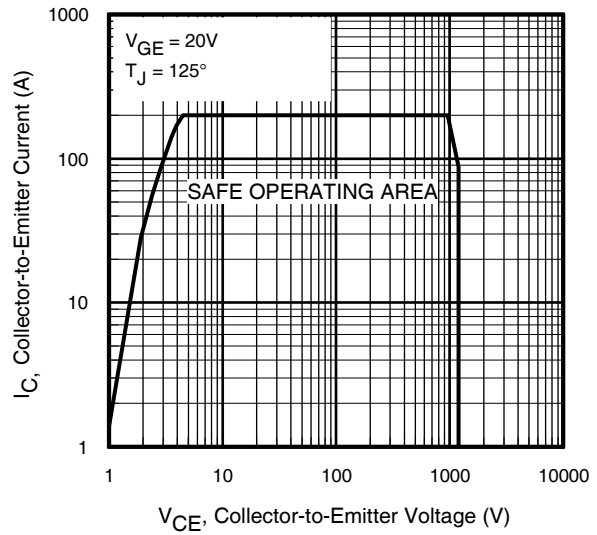
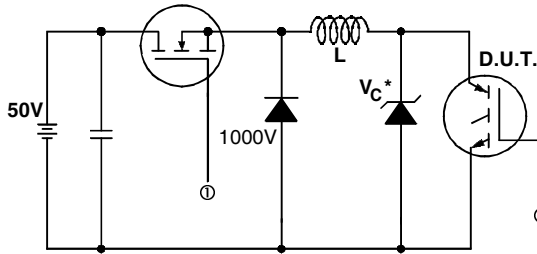

Fig. 12 - Turn-Off SOA



* Driver same type as D.U.T.; $V_c = 80\%$ of $V_{ce(max)}$
 * Note: Due to the 50V power supply, pulse width and inductor will increase to obtain rated I_d .

Fig. 13a - Clamped Inductive Load Test Circuit

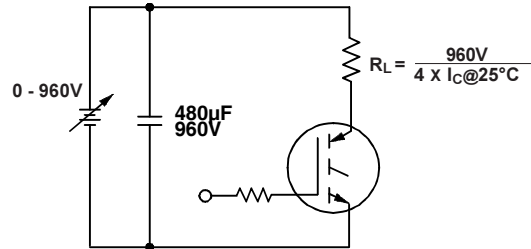

Fig. 13b - Pulsed Collector Current Test Circuit

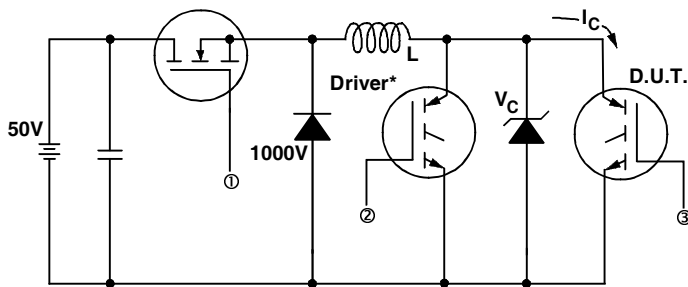

Fig. 14a - Switching Loss Test Circuit

* Driver same type as D.U.T., $V_c = 960V$

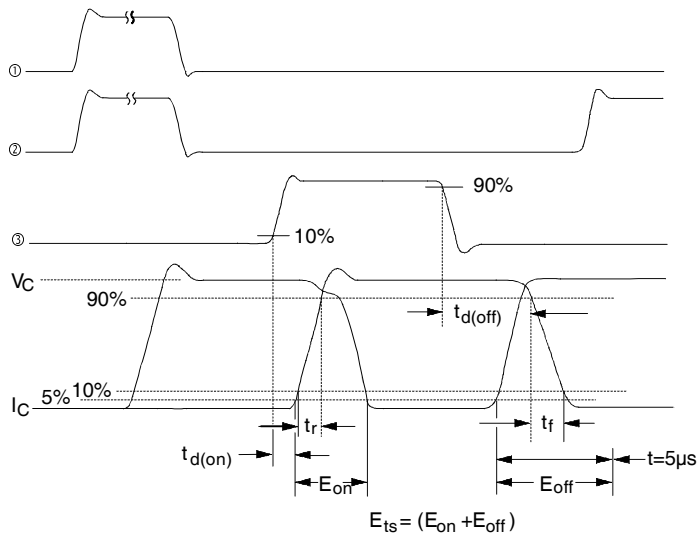
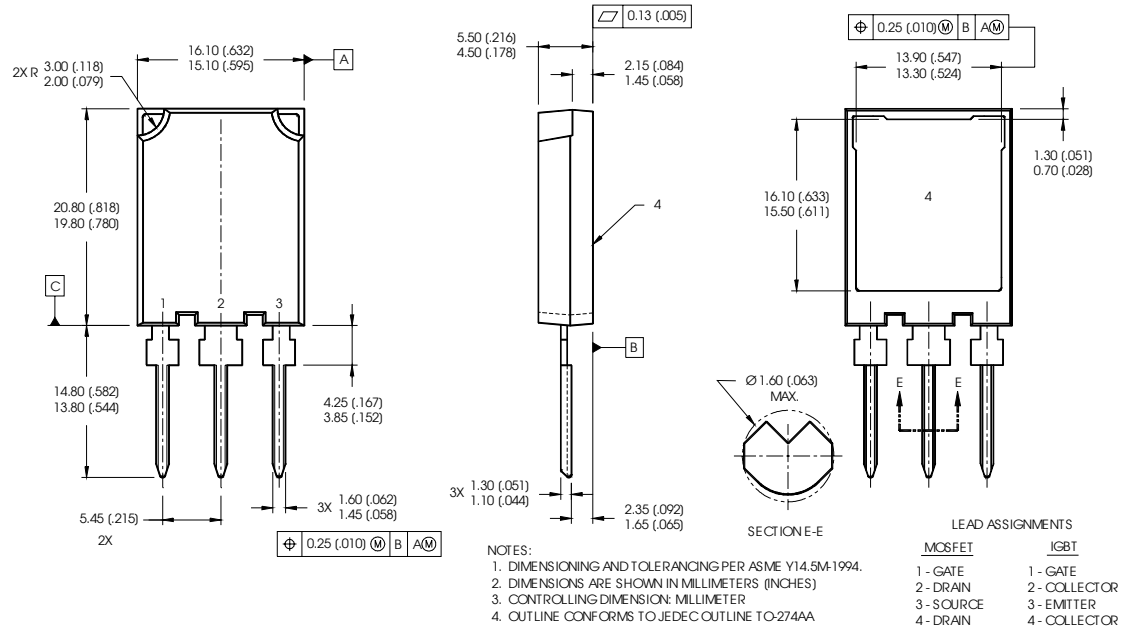

Fig. 14b - Switching Loss Waveforms

IRG4PSH71U

International
IR Rectifier

Super-247™ (TO-274AA) Package Outline



Super-247™ (TO-274AA) Part Marking Information

EXAMPLE: THIS IS AN IRFPS37N50A WITH ASSEMBLY LOT CODE A8B9

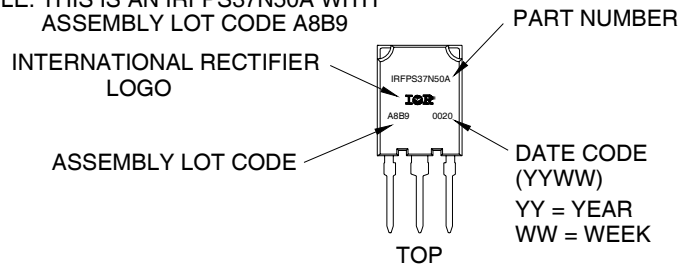

Super TO-247™ package is not recommended for Surface Mount Application.

Data and specifications subject to change without notice.
This product has been designed and qualified for the Consumer market.
Qualification Standards can be found on IR's Web site.

International
IR Rectifier

IR WORLD HEADQUARTERS: 233 Kansas St., El Segundo, California 90245, USA Tel: (310) 252-7105
TAC Fax: (310) 252-7903

Visit us at www.irf.com for sales contact information.5/04

www.irf.com