



®

深圳匡通电子有限公司

SHENZHEN KENTO ELECTRONICCO .,LTD

SPECIFICATION FOR APPROVAL

Product Name: 5050 Warm White SMD Light Emitting Diode**Product No.:** KT-5050-WW**Client's name:** _____**Customer No.:** _____**Release Date:** May 2017

SHENZHEN KENTO ELECTRONICCO .,LTD		
Issue by	Confirm	Examine

Client Approve		
Confirm	Eaxmine	Approve

SHENZHEN KENTO ELECTRONIC CO., LTD.

TEL: 0755-27823321

FAX: 0755-27822276

Part No.:KT-5050-WW

Application:

- Normal lighting
- LED bulbs
- LED back lighting
- LED home lighting
- Other lightings

Product size:

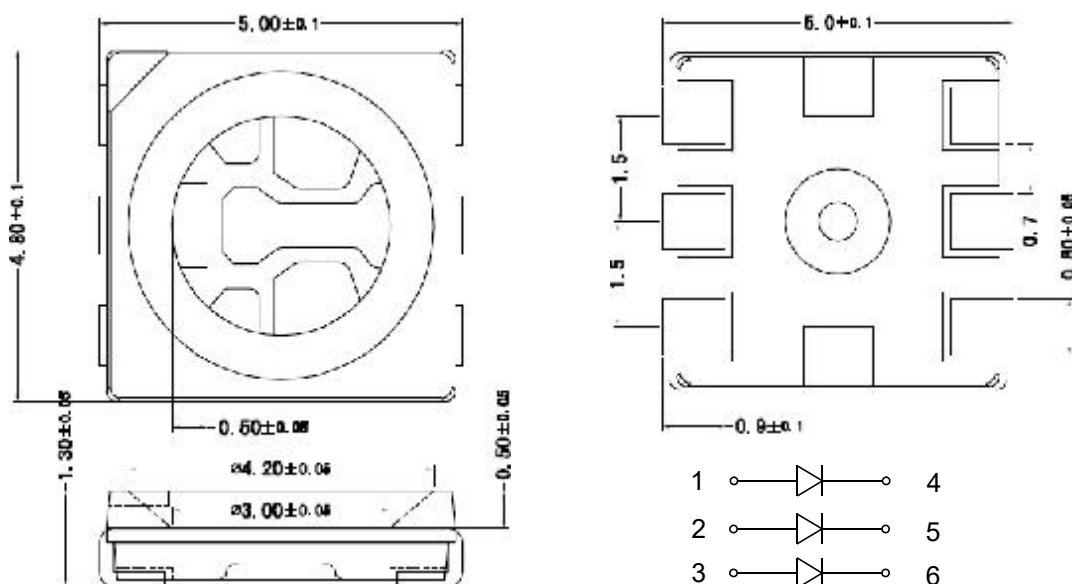

Note:

the incision side is negative pole.

All units are mm, if not specially pointing out tolerance is ± 0.1 mm.



匡通电子

Product Specification for approval

Part No. : KT-5050-WW

Version

A.2

Issue date

2017.05.17

Page

3 / 12

Photoelectric parameters (Ta=25°C):

Item	Symbol	Min.	Typical	Max.	Unit	Test condition
Forward Voltage	VR	3.0	-	3.4	V	IF=60mA
Reverse Current	IR	-	-	1	uA	VR = 7V
Color Temperature	TC	2800	-	3000	K	IF=60mA
Luminous Flux	Φ	16	-	22	lm	IF=60mA
Color Rendering Index	CRI	60	-	-	-	IF=60mA
Half-intensity viewing angle	2θ1/2	-	125	-	Deg	IF=60mA

Maximum absolute rating (Ta=25°C):

Item	Symbol	Maximum Rate	Unit
Power Consumption	PD	200	mW
Forward DC Working Current	IF	60	mA
Peak forward current	IFP	65	mA
Reverse voltage	VR	9	V
Junction Temperature		≤ 125° C	
Pin Temperature		≤ 60° C	



匡通电子

Product Specification for approval

Part No. : KT-5050-WW

Version	A.2	Issue date	2017.05.17	Page	4 / 12
---------	-----	------------	------------	------	--------

Working Temperature	-20° C To +85° C
Storage Temperature	-20° C To +85° C

1/10 duty cycle, 0.1ms pulse width

Remarks:

- 1、 Light intensity tolerance: $\pm 10\%$ 。
- 2、 Forward voltage tolerance: $\pm 0.05V$ 。

Typical Photoelectric Curve:

Relative intensity vs wavelength waveform

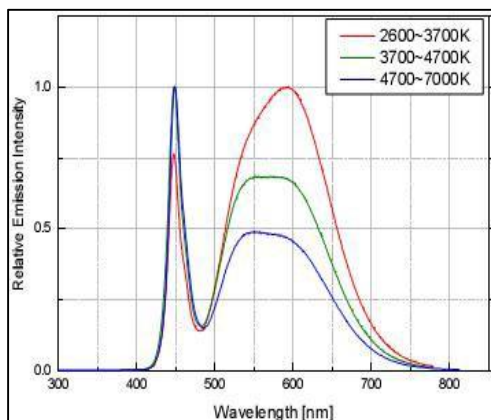

Forward current vs forward voltage
Forward current and voltage

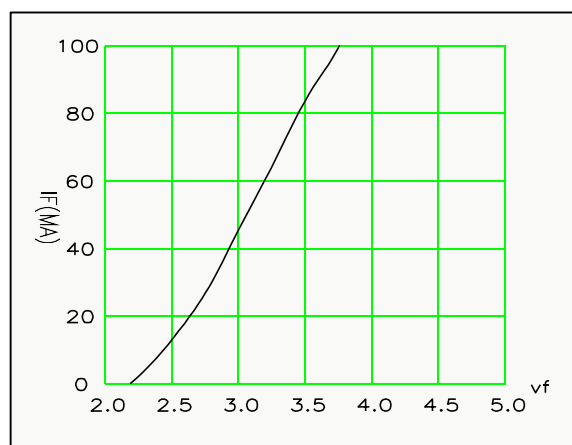

Forward current vs ambient Temperature

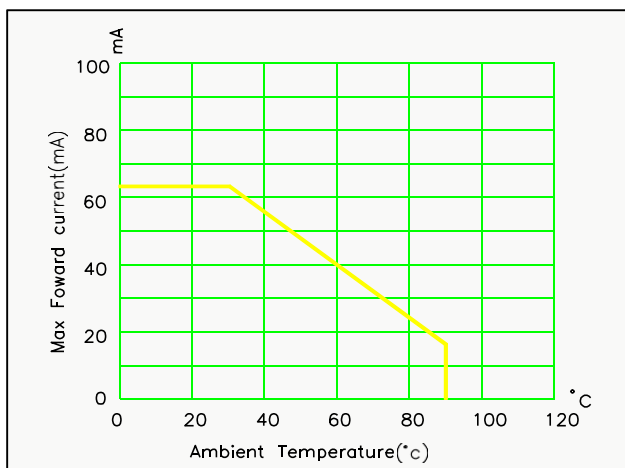

Spatial Distribution

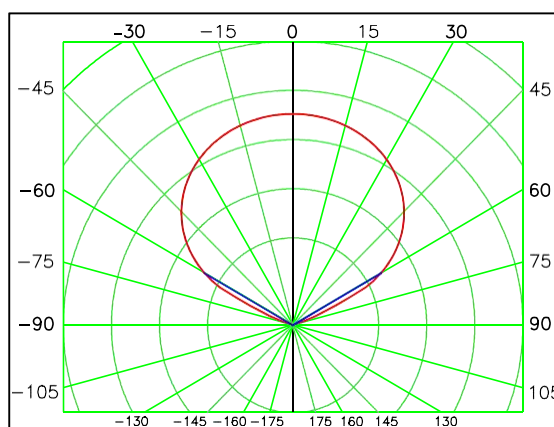



匡通电子

Product Specification for approval

Part No. : KT-5050-WW

Version

A.2

Issue date

2017.05.17

Page

6 / 12

CIE 1931(X,Y) Chromaticity coordinates: warm white 2800-3000K

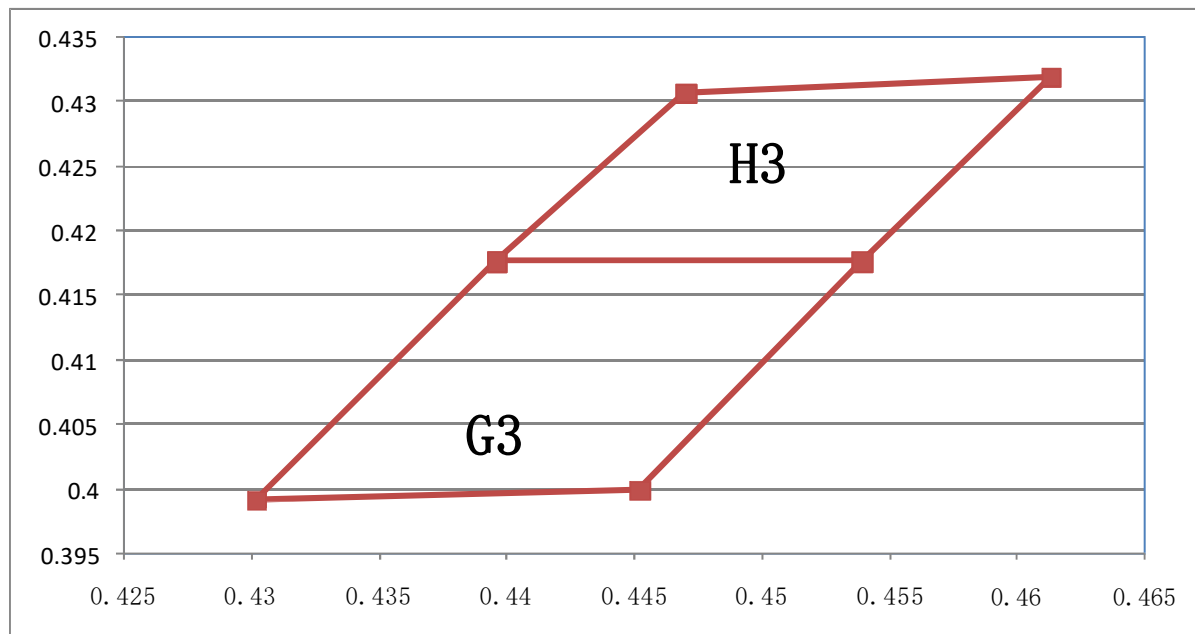

Reliability Test:

No.	Test Item	Test Condition	Sample Sum	Y/N
1	Life test	current: 60mA temp.: 25°C test time: 1000 hrs	50	0/1
2	High temperature high humidity Static test	temp.: =+85 °C Humidity : 85% RH test time: 1000 hrs	50	0/1
3	Thermal Shock	-40°C~+125°C 20min 10s 20min test time: 100 cycles	50	0/1
4	High temperature storage	High temperature: 100°C test time: 1000 hrs	50	0/1
5	Low temperature storage	Low temperature: -40°C test time: 1000 hrs	50	0/1
6	temp. cycles	-40°C ~ +100°C 60min 20min	50	0/1



匡通电子

Product Specification for approval

Part No. : KT-5050-WW

Version	A.2	Issue date	2017.05. 17	Page	7 / 12
---------	-----	------------	-------------	------	--------

		60min test time: 20 cycles		
7	Reflow soldering	260°C (Max.), not more than 10s	50	0/1

Fail standard:

• Iv: decay more than 5%

• Vf: change more than 5%

Solderign

Manual soldering:

- A. Soldering iron watt must under 25W 25W, temp. must keep under 350°C , solder tiem no more than 2s.
- B. Soldering iron must not tough sillicion rubber part.
- C. After soldring work ,must let it cool under 40°C, then could start package.

Reflow soldring:

a. Reflow soldering temp. curve:

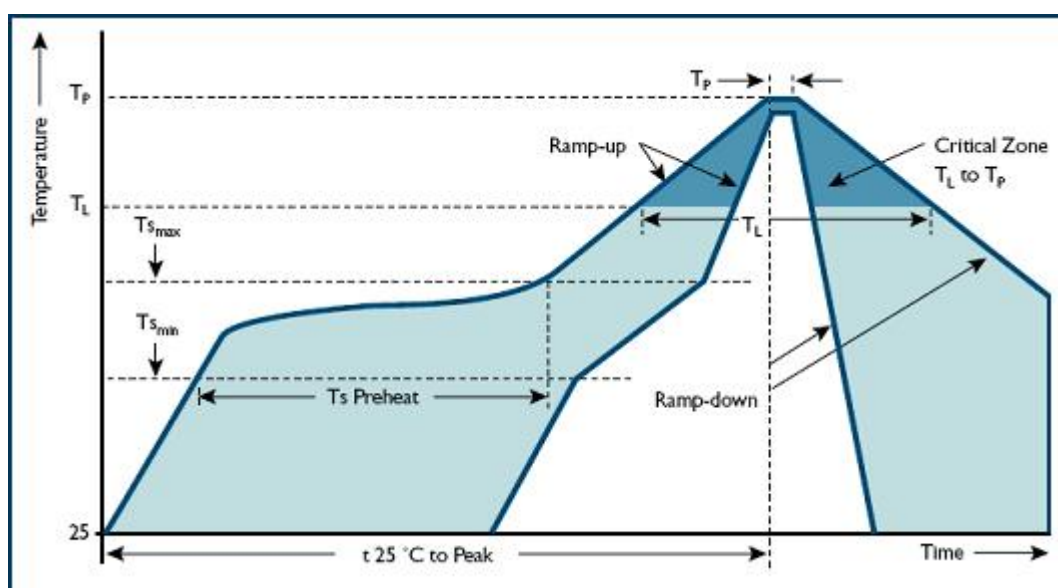

solder : lead includ	solder : no lead
Temp. increase rate= 4°C/s max	Temp. increase rate= 4°C/s max
Preheat temp = 100°C ~150°C	Prehear temp = 150°C ~200°C
Preheat time = 100s max	Preheat time = 100s max.
Temp. decrease rate 6°C/s max	Temp. decrease rate 6°C/s max
Peak temp. = 230°C max	Peak temp = 250°C max
While reach peak temp±5°C time stay should less than 10s	While reach peak temp±5°C time stay should less than 10s
While temp at 183°C ,time stay should less than 80s.	While temp at 217°C ,time stay should less than 80s.

b. after solder finish do not modify the soder ,if have to modify make sure not hurt the pad.

c.、 reflow solder should finish in one time, do not solder many times.



匡通电子

Product Specification for approval

Part No. : KT-5050-WW

Version	A.2	Issue date	2017.05. 17	Page	9 / 12
---------	-----	------------	-------------	------	--------

d.、 afte solder finish do not pack pcb immediately.pack after the pcb hac cooled down

Package

1) 1000pcs/reel&3500pcs/reel。

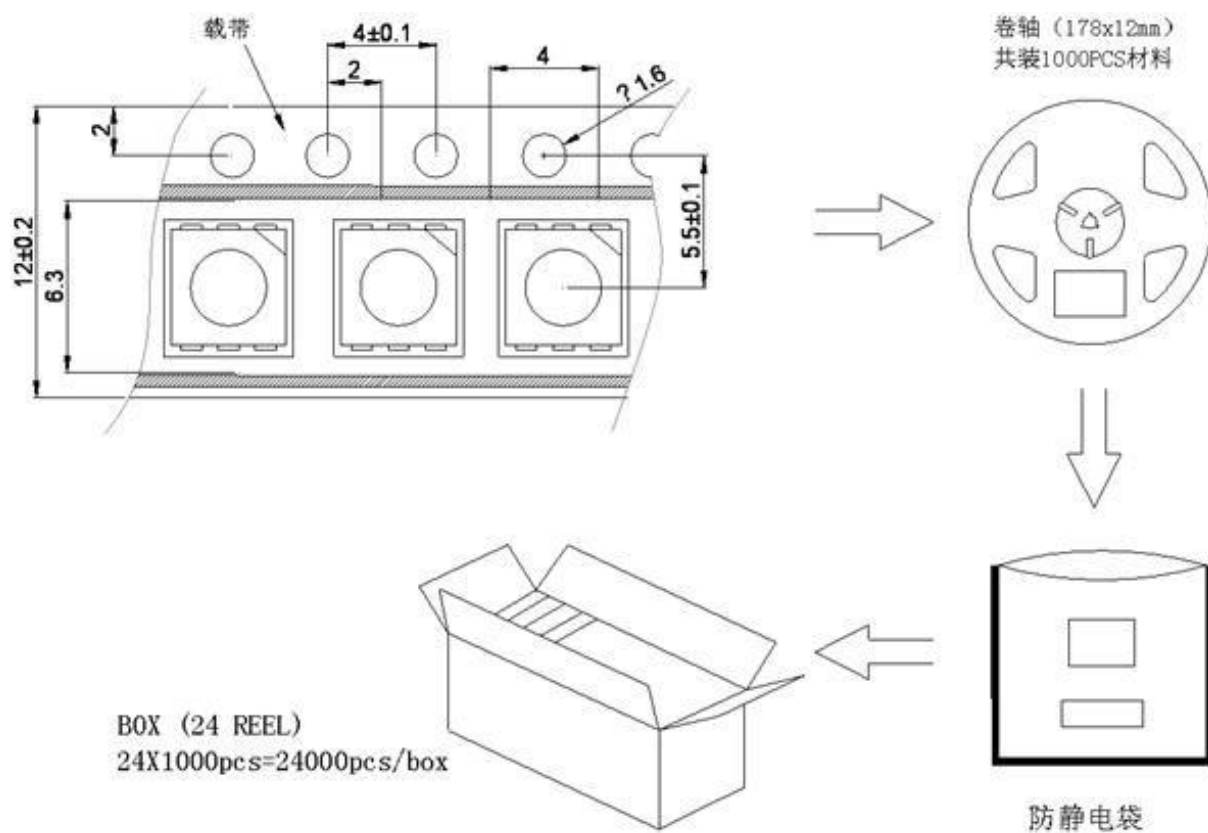



匡通电子

Product Specification for approval

Part No. : KT-5050-WW

Version	A.2	Issue date	2017.05.17	Page	11 / 12
---------	-----	------------	------------	------	---------

ATTENTIONS:

◆ Use:

1. Excessive temperature will affect the brightness and other performance of the LED, so in order to make the LED have better performance, the LED should be

Keep away from heat sources.

2. Tolerance of photoelectric parameters:

Forward Voltage (REF / VF): $\pm 0.1V$

Brightness (CAT/IV): $\pm 15\%$

Wavelength (HUE / WLD): $\pm 1nm$

◆ Storage:

1. If the original packaging is not opened, the recommended storage environment is: temperature $5^{\circ}C \sim 30^{\circ}C$, humidity below 85%RH. When the inventory exceeds two months, dehumidification should be done before use, and the condition is $60^{\circ}C / 8$ hours;

2. After opening the original packaging, the recommended storage environment is:

3. LEDs are humidity-sensitive components. In order to prevent the components from absorbing moisture, it is recommended to store them in an airtight container with desiccant after opening the package, or in a nitrogen moisture-proof cabinet; temperature $5^{\circ}C \sim 30^{\circ}C$, humidity below 60%;

4. After opening the package, the components should be used within 168 hours (7 days); and the welding should be completed as soon as possible after the patch;

5. If the desiccant fails or the components are exposed to the air for more than 168 hours (7 days), dehumidification should be done;

Baking condition: $60^{\circ}C/24$ hours.

◆ ESD electrostatic protection

LEDs (especially blue, emerald green, violet, white, and pink LEDs using InGaN structure wafers) are static-sensitive components, and static electricity or current overload can damage the LED structure. The LED is damaged by static electricity or current overload may cause abnormal performance, such as excessive leakage current, low VF, or failure to light up, etc. So please note the following:



匡通电子

Product Specification for approval

Part No. : KT-5050-WW

Version

A.2

Issue date

2017.05. 17

Page

12 / 12

1. Wear an anti-static wrist strap or anti-static gloves when touching the LED;
2. All machinery and equipment, tools, work tables, material racks, etc., should be properly grounded (within 10Ω of ground impedance);
3. Anti-static bags, anti-static boxes and anti-static turnover boxes should be used for storage or handling of LEDs, and ordinary plastic products are strictly prohibited;
4. It is recommended to use an ion fan to suppress the generation of static
5. The electrostatic field voltage is less than 100V within 1 foot distance from the LED element.
electricity during the operation;