

■Features

- Bi-Color
- Super high brightness of surface mount LED
- Water Clear Flat Mold
- Compact package outline
(LxWxT) of 1.6mm x 1.6mm x 0.65mm
- Compatible to IR reflow soldering.

■Applications

- Backlighting (switches, keys, etc.)
- Marker lights (e.g. steps, exit ways, etc.)
-

■Outline Dimension

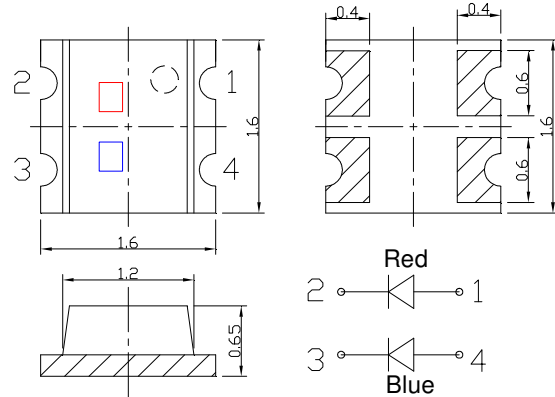

Notes: 1. All dimensions are in millimeters ;
2. Tolerance is ± 0.10 mm unless otherwise noted.

■Absolute Maximum Rating (Ta=25°C)



Item	Symbo	Value		Unit
		Red	Blue	
DC Forward Current	I _F	30	20	mA
Pulse Forward Current*	I _{FP}	100	100	mA
Reverse Voltage	V _R	5	5	V
Power Dissipation	P _D	78	72	mW
Operating Temperature	Topr	-40 ~ +85		°C
Storage Temperature	Tstg	-40~ +85		°C
Lead Soldering Temperature	Tsol	260°C /5sec		-

*Pulse width Max 0.1ms, Duty ratio max 1/10

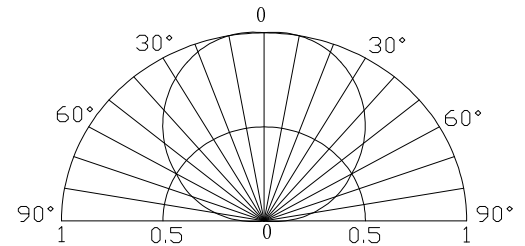
■Directivity



■Electrical -Optical Characteristics (Ta=25°C)

Part Number	Color			V _F (V)			I _R (μA)	I _v (mcd)			λD (nm)			2θ1/2 (deg)
				Min.	Typ.	Max.	Max.	Min.	Typ.	Max.	Min.	Typ.	Max.	Typ.
				I _F =20mA			V _R =5V	I _F =20mA						
OSRB0603C1C	Red	HR		1.8	2.1	2.6	10	-	120	-	620	630	640	120
	Blue	BL		2.9	3.1	3.6	10	-	80	-	460	465	475	120

Note: * V_f tolerance: ±0.05V

* Dominant wavelength tolerance: ±1nm

* Luminous intensity is NIST reading. Luminous intensity tolerance: ±10%

■ Recommended Soldering Temperature – Time Profile (Reflow Soldering)

Surface Mounting Condition

In automatic mounting of the SMD LEDs on printed circuit boards, any bending, expanding and pulling forces or shock against the SMD LEDs should be kept min. to prevent them from electrical failures and mechanical damages of the devices.

Soldering Reflow

- Soldering of the SMD LEDs should conform to the soldering condition in the individual specifications.
- SMD LEDs are designed for Reflow Soldering.
- In the reflow soldering, too high temperature and too large temperature gradient such as rapid heating/cooling may cause electrical & optical failures and damages of the devices.
- We cannot guarantee the LEDs after they have been assembled using the solder dipping method.

1) Lead Solder

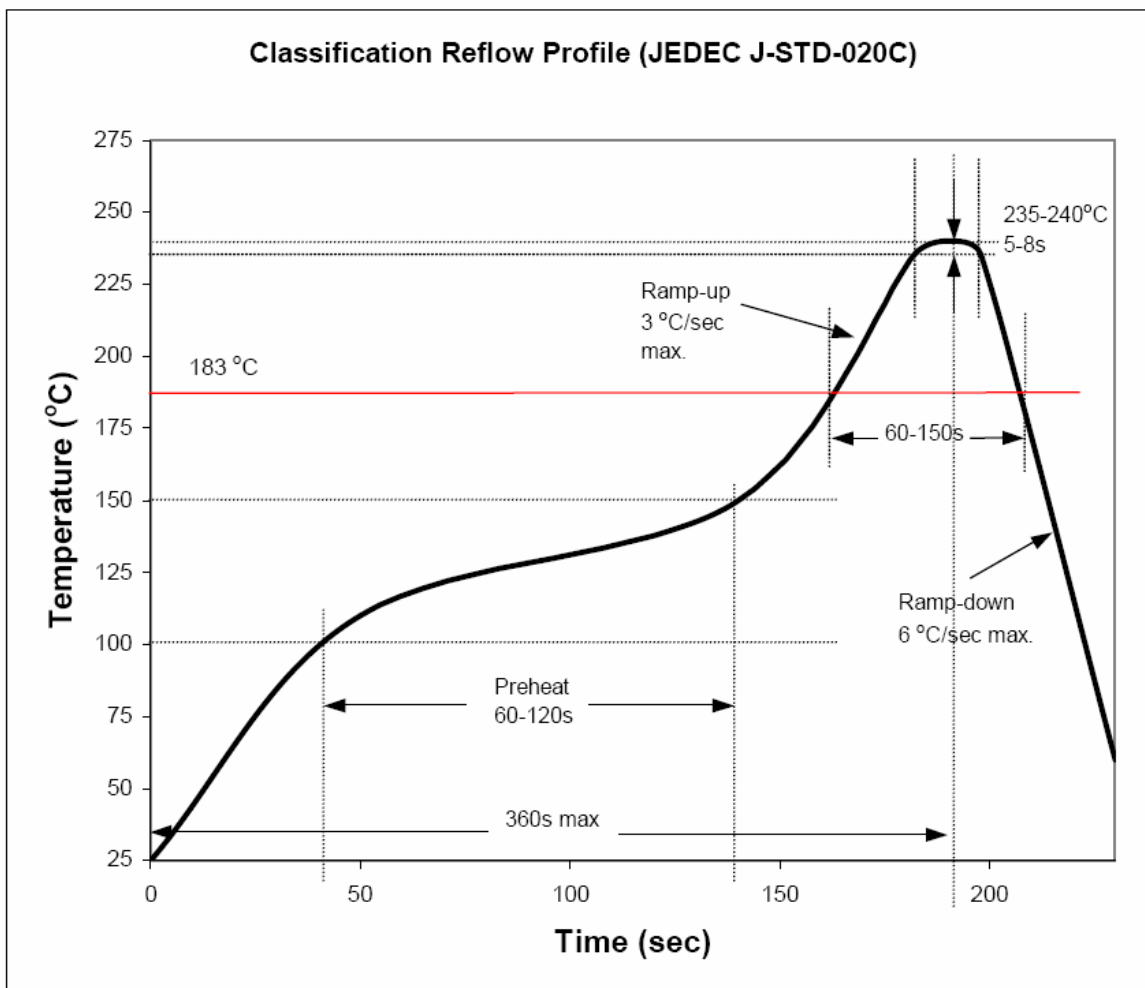

2) Lead-Free Solder

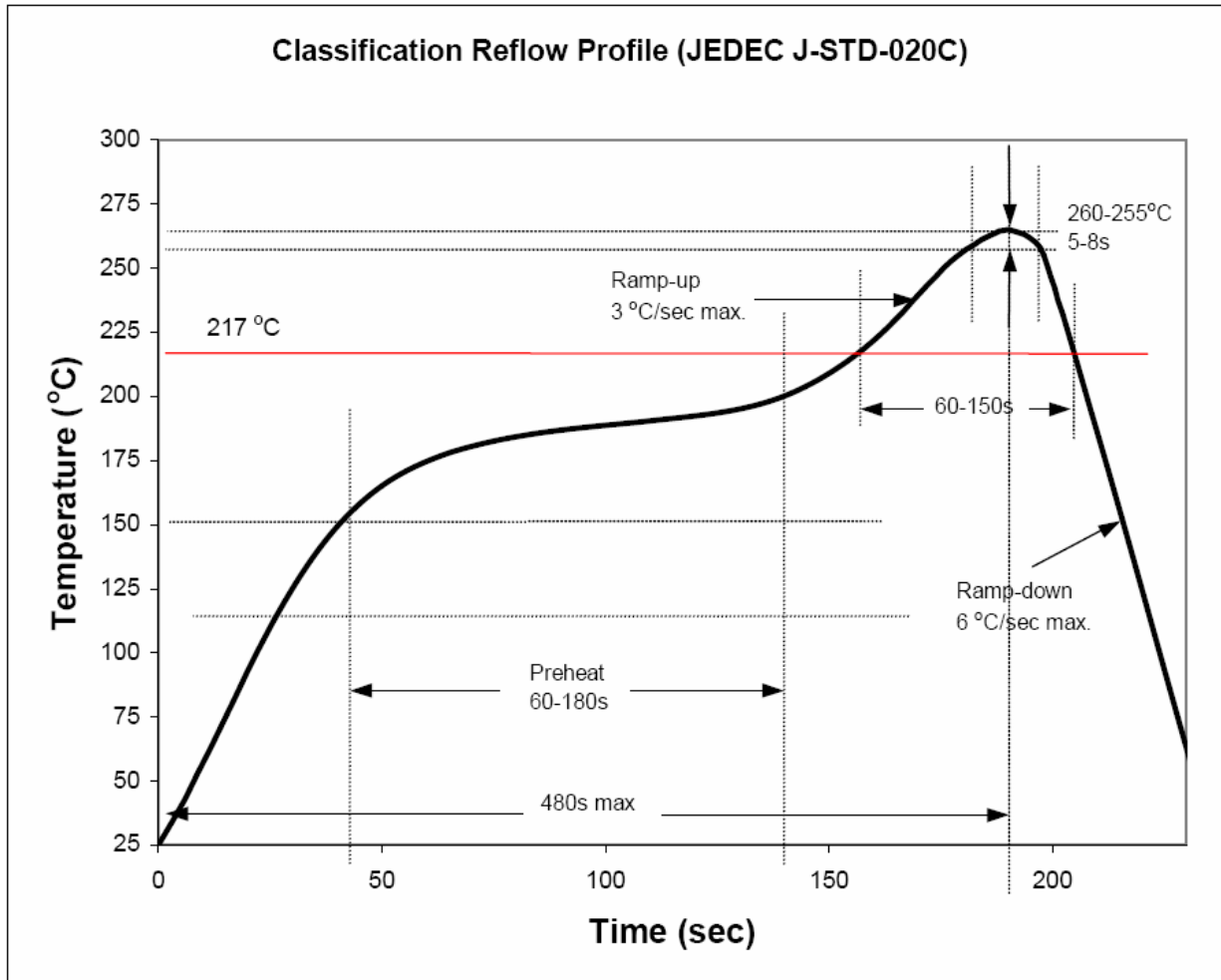

3) Manual Soldering conditions.

- Lead Solder

Max. 300 for Max. 3sec, and only one time. °C

- Lead-free Solder

Max. 350 for Max. 3sec, and only one time. °C

- There is possibility that the brightness of LEDs is decreased, which is influenced by heat or ambient atmosphere during reflow. It is recommended to use the nitrogen reflow method.

- After LEDs have been soldered, repair should not be done. As repair is unavoidable, a double-head soldering iron should be used. It should be confirmed beforehand whether the characteristics of the LEDs will be damaged by repairing or not.

- Reflow soldering should not be done more than two times.

■ **Material**

True green :

	Material
1. Lead-frame. / Soldering Leads	Cu Alloy With Ni, Au Plating.
2. PCB	BT Resin.
3. Encapsulant	Epoxy Resin.
4. Die	InGaN based
5. Zener diode	Si
6. Bonding wire	Au Chip : Ball Bonding / PCB : Ball Bonding

Note: Product is lead-free (Pb free).

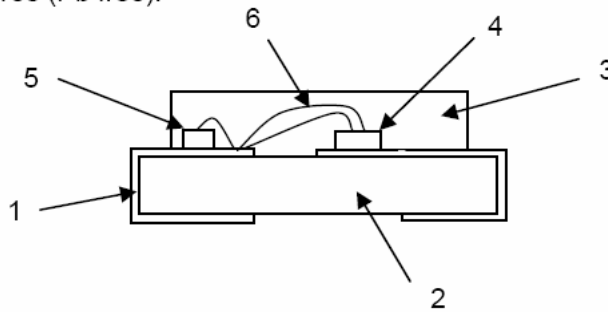

White/ Blue/ Yellow green/ Yellow/ Orange/ Red :

	Material
1. Lead-frame. / Soldering Leads	Cu Alloy With Ni, Au Plating.
2. PCB	BT Resin.
3. Encapsulate	Epoxy Resin.
4. Die	AllnGaP based
5. Bonding wire	Au Chip : Ball Bonding / PCB : Ball Bonding

Note: Product is lead-free (Pb free).

