

POW-HVM4.5K-24V

POW-HVM6.5K-48V

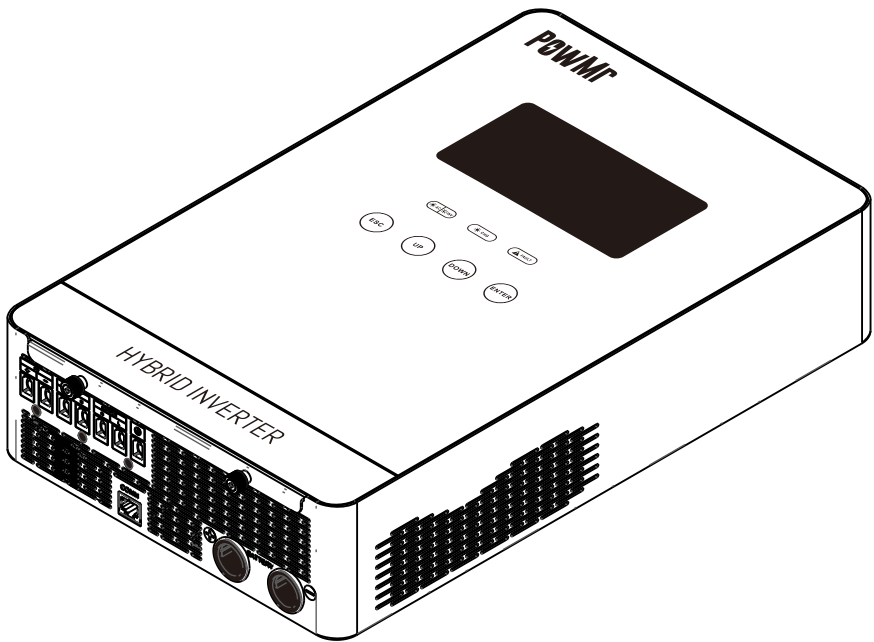

# POWMr

SOLAR INVERTER CHARGER

User Manual

# Table Of Contents

<b>ABOUT THIS MANUAL .....</b>	<b>1</b>
Purpose.....	1
Scope .....	1
<b>SAFETY INSTRUCTIONS.....</b>	<b>1</b>
<b>INTRODUCTION .....</b>	<b>2</b>
Features .....	2
Basic System Architecture .....	2
Product Overview.....	3
<b>INSTALLATION .....</b>	<b>4</b>
Unpacking and Inspection.....	4
Preparation .....	4
Mounting the Unit.....	4
Battery Connection .....	5
AC Input/Output Connection .....	7
PV Connection .....	8
Final Assembly.....	9
<b>OPERATION .....</b>	<b>10</b>
Power ON/OFF .....	10
Operation and Display Panel .....	10
LCD Display Icons .....	11
LCD Setting.....	13
Display Setting .....	20
Operating Mode Description .....	22
Fault Reference Code.....	26
Warning Indicator .....	27
<b>SPECIFICATIONS .....</b>	<b>28</b>
Table 1 Line Mode Specifications .....	28
Table 2 Inverter Mode Specifications .....	29
Table 3 Charge Mode Specifications .....	30
Table 4 General Specifications .....	31
<b>TROUBLE SHOOTING.....</b>	<b>32</b>
<b>Appendix: Approximate Back-up Time Table .....</b>	<b>33</b>

# ABOUT THIS MANUAL

## Purpose

This manual describes the assembly, installation, operation and troubleshooting of this unit. Please read this manual carefully before installations and operations. Keep this manual for future reference.

## Scope

This manual provides safety and installation guidelines as well as information on tools and wiring.

# SAFETY INSTRUCTIONS



**WARNING: This chapter contains important safety and operating instructions. Read and keep this manual for future reference.**

1. Before using the unit, read all instructions and cautionary markings on the unit, the batteries and all appropriate sections of this manual.
2. **CAUTION** --To reduce risk of injury, charge only deep-cycle lead acid type rechargeable batteries. Other types of batteries may burst, causing personal injury and damage.
3. Do not disassemble the unit. Take it to a qualified service center when service or repair is required. Incorrect re-assembly may result in a risk of electric shock or fire.
4. To reduce risk of electric shock, disconnect all wirings before attempting any maintenance or cleaning. Turning off the unit will not reduce this risk.
5. **CAUTION** – Only qualified personnel can install this device with battery.
6. **NEVER** charge a frozen battery.
7. For optimum operation of this inverter/charger, please follow required spec to select appropriate cable size. It's very important to correctly operate this inverter/charger.
8. Be very cautious when working with metal tools on or around batteries. A potential risk exists to drop a tool to spark or short circuit batteries or other electrical parts and could cause an explosion.
9. Please strictly follow installation procedure when you want to disconnect AC or DC terminals. Please refer to INSTALLATION section of this manual for the details.
10. **GROUNDING INSTRUCTIONS** -This inverter/charger should be connected to a permanent grounded wiring system. Be sure to comply with local requirements and regulation to install this inverter.
11. **NEVER** cause AC output and DC input short circuited. Do NOT connect to the mains when DC input short circuits.
12. **Warning!!** Only qualified service persons are able to service this device. If errors still persist after following troubleshooting table, please send this inverter/charger back to local dealer or service center for maintenance.

# INTRODUCTION

This is a multi-function inverter/charger, combining functions of inverter, MPPT solar charger and battery charger to offer uninterruptible power support with portable size. Its comprehensive large LCD display offers user-configurable and easy-accessible touch button operation such as battery charging current, AC/solar charger priority, and acceptable input voltage based on different applications.

## Features

- Pure sine wave solar inverter
- Unique glass top cover design with 6.25inch LCD display and touchable buttons
- Built-in 150A MPPT (Max PV) solar charger
- High PV input range from 120V-450Vdc
- Smart battery charger design for optimized battery performance
- Configurable AC/Battery input priority via LCD setting
- Auto restart while PV is recovering
- Over-load , over temperature and output short circuit protection
- Cold restart function
- Built-in lithium battery automatic activation
- Communication with RS232/RS485
- WiFi monitoring function (optional )
- Anti-dust kit for harsh environment(optional)
- Restore default Settings with one click

## Basic System Architecture

The following illustration shows basic application for this inverter/charger. It also includes following devices to have a complete running system:

- Generator or Utility.
- PV modules (option)

Consult with your system integrator for other possible system architectures depending on your requirements.

This inverter can power all kinds of appliances in home or office environment, including motor-type appliances such as tube light, fan, refrigerator and air conditioner.

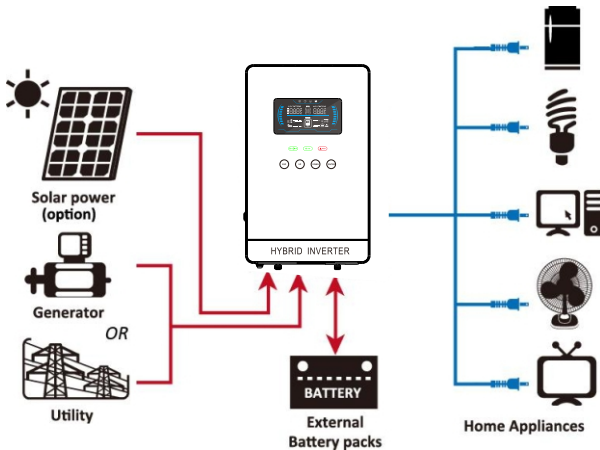
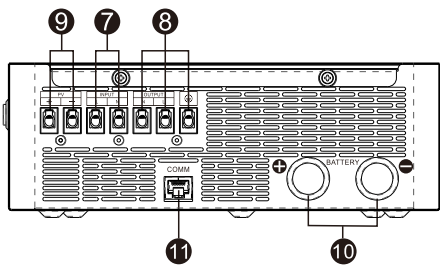
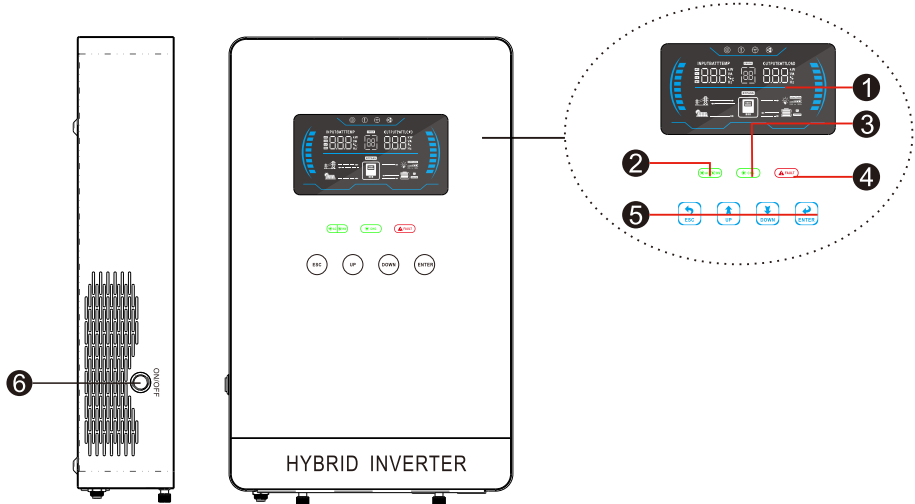

Figure 1 Hybrid Power System



# Product Overview



1. LCD display
2. Status indicator
3. Charging indicator
4. Fault indicator
5. Function touch buttons
6. Power on/off switch
7. AC input
8. AC output
9. PV input
10. Battery input
11. RS485/RS232 communication port

# INSTALLATION

## Unpacking and Inspection

Before installation, please inspect the unit. Be sure that nothing inside the package is damaged. You should have received the following items inside of package:

- The unit x 1
- User manual x 1

## Preparation

Before connecting all wirings, please take off bottom cover by removing two screws as shown below.

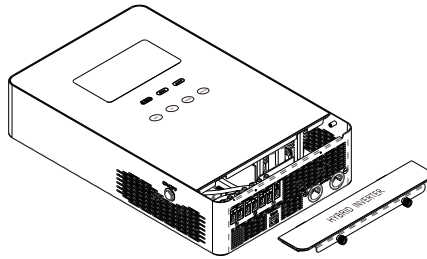

## Mounting the Unit

Consider the following points before selecting where to install:

- Do not mount the inverter on flammable construction materials.
- Mount on a solid surface
- Install this inverter at eye level in order to allow the LCD display to be read at all times.
- The ambient temperature should be between 0°C and 55°C to ensure optimal operation.
- The recommended installation position is to be adhered to the wall vertically.
- Be sure to keep other objects and surfaces as shown in the right diagram to guarantee sufficient heat dissipation and to have enough space for removing wires.

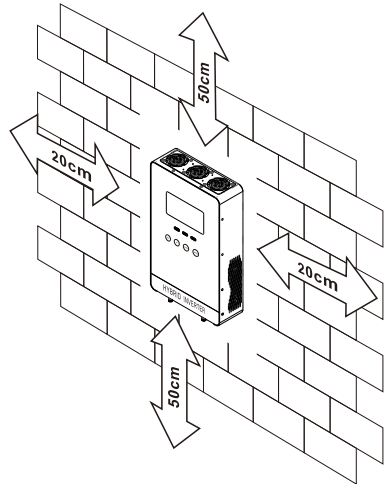

**SUITABLE FOR MOUNTING ON CONCRETE OR OTHER NON-COMBUSTIBLE SURFACE ONLY.**

Install the unit by screwing two screws.

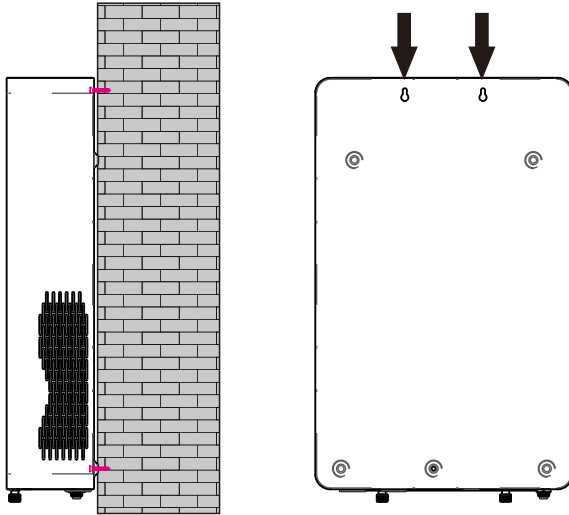

## Battery Connection

**CAUTION:** For safety operation and regulation compliance, it's requested to install a separate DC over-current protector or disconnect device between battery and inverter. It may not be requested to have a disconnect device in some applications, however, it's still requested to have over-current protection installed. Please refer to typical amperage in below table as required fuse or breaker size.

**WARNING!** All wiring must be performed by a qualified personnel.

**WARNING!** It's very important for system safety and efficient operation to use appropriate cable for battery connection. To reduce risk of injury, please use the proper recommended cable and terminal size as below.

**Ring terminal:**

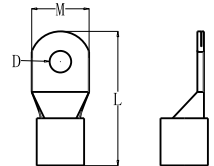

**Recommended battery cable and terminal size:**

Model	Typical Amperage	Battery Capacity	Wire Size	Ring Terminal				Torque Value
				Cable mm <sup>2</sup>	Dimensions			
					D (mm)	L (mm)	M (mm)	
4.5KW 24V	200A	100AH	1*2AWG	35	8	44	18.2	2~ 3 Nm
		200AH	2*4AWG	35	8	44	18.2	
6.5 KW 48V	135A	200AH	1*4AWG	22	8	44	18.2	2~ 3 Nm
			2*8AWG	22	8	44	18.2	

Please follow below steps to implement battery connection:

1. Assemble battery ring terminal based on recommended battery cable and terminal size.
2. Connect all battery packs as units requires.

**NOTE:** Please only use sealed lead acid battery or sealed GEL/AGM lead-acid battery or lithium battery.

3. Insert the ring terminal of battery cable flatly into battery connector of inverter and make sure the bolts are tightened with torque of 2-3 Nm. Make sure polarity at both the battery and the inverter/charge is correctly connected and ring terminals are tightly screwed to the battery terminals.

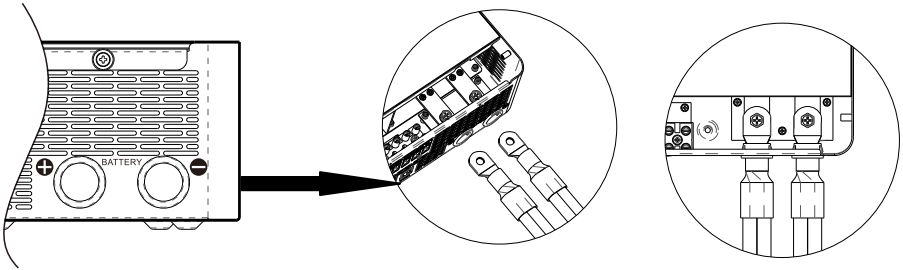

**WARNING: Shock Hazard**

Installation must be performed with care due to high battery voltage in series.



**CAUTION!!** Do not place anything between the flat part of the inverter terminal and the ring terminal. Otherwise, overheating may occur.

**CAUTION!!** Do not apply anti-oxidant substance on the terminals before terminals are connected tightly.

**CAUTION!!** Before making the final DC connection or closing DC breaker/disconnector, be sure positive (+) must be connected to positive (+) and negative (-) must be connected to negative (-).

## AC Input/Output Connection

**CAUTION!!** Before connecting to AC input power source, please install a **separate** AC breaker between inverter and AC input power source. This will ensure the inverter can be securely disconnected during maintenance and fully protected from over current of AC input. The recommended spec of AC breaker is for 32A for 4.5KW , 50A for 6.5KW.

**CAUTION!!** There are two terminal blocks with "INPUT" and "OUTPUT" markings. Please do NOT mis-connect input and output connectors.

**WARNING!** All wiring must be performed by a qualified personnel.

**WARNING!** It's very important for system safety and efficient operation to use appropriate cable for AC input connection. To reduce risk of injury, please use the proper recommended cable size as below.

### Suggested cable requirement for AC wires

Model	Gauge	Torque Value
4.5KW	12 AWG	1.2~ 1.6 Nm
6.5KW	8 AWG	1.4~ 1.6Nm

Please follow below steps to implement AC input/output connection:

1. Before making AC input/output connection, be sure to open DC protector or disconnecter first.
2. Remove insulation sleeve 10mm for six conductors. And shorten phase L and neutral conductor N 3 mm.
3. Insert AC input wires according to polarities indicated on terminal block and tighten the terminal screws.

**L→LINE (brown or white)**

**N→Neutral (blue or black)**

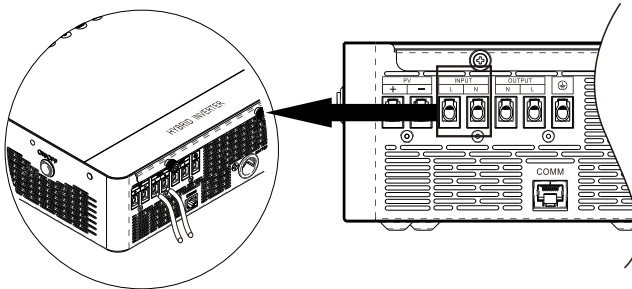

### **WARNING:**

Be sure that AC power source is disconnected before attempting to hardwire it to the unit.

4. Then, insert AC output wires according to polarities indicated on terminal block and tighten terminal screws. Be sure to connect PE protective conductor (⊕) first.

- ⊕ → **Ground (yellow-green)**
- L → **LINE (brown or white)**
- N → **Neutral (blue or black)**

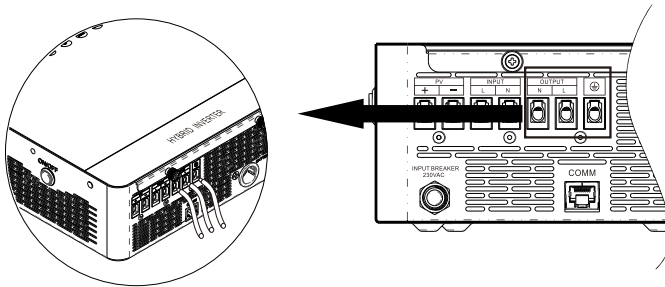

5. Make sure the wires are securely connected.

**CAUTION: Important**

Be sure to connect AC wires with correct polarity. If L and N wires are connected reversely, it may cause utility short-circuited when these inverters are worked in parallel operation.

**CAUTION:** Appliances such as air conditioner are required at least 2~3 minutes to restart because it's required to have enough time to balance refrigerant gas inside of circuits. If a power shortage occurs and recovers in a short time, it will cause damage to your connected appliances. To prevent this kind of damage, please check manufacturer of air conditioner if it's equipped with time-delay function before installation. Otherwise, this inverter/charger will trig overload fault and cut off output to protect your appliance but sometimes it still causes internal damage to the air conditioner.

## PV Connection

**CAUTION:** Before connecting to PV modules, please install **separately** a DC circuit breaker between inverter and PV modules.

**WARNING!** All wiring must be performed by a qualified personnel.

**WARNING!** It's very important for system safety and efficient operation to use appropriate cable for PV module connection. To reduce risk of injury, please use the proper recommended cable size as below.

Model	Wire Size	Cable (mm <sup>2</sup> )	Torque value (max)
4.5KW/6.5KW	1 x 12AWG	4	1.2 Nm

**PV Module Selection:**

When selecting proper PV modules, please be sure to consider below parameters:

1. Open circuit Voltage (Voc) of PV modules not exceeds max. PV array open circuit voltage of inverter.
2. Open circuit Voltage (Voc) of PV modules should be higher than min. PV Array MPPT Voltage range.

<b>INVERTER MODEL</b>	4.5KW	6.5KW
<b>Max. PV Array Open Circuit Voltage</b>	450Vdc	
<b>PV Array MPPT Voltage Range</b>	120Vdc~450Vdc	

Take 250Wp PV module as an example. After considering above two parameters, the recommended module configurations are listed as below table.

Solar Panel Spec. (reference)	SOLAR INPUT		Q'ty of panels	Total input power
	(Min in serial: 6 pcs, max. in serial: 13 pcs)			
- 250Wp	6 pcs in serial		6 pcs	1500W
- Vmp: 30.1Vdc	8 pcs in serial		8 pcs	2000W
- Imp: 8.3A	12 pcs in serial		12 pcs	3000W
- Voc: 37.7Vdc	13 pcs in serial		13 pcs	3250W
- Isc: 8.4A	8 pieces in serial and 2 sets in parallel		16 pcs	4000W
- Cells: 60	10 pieces in serial and 2 sets in parallel		20 pcs	5000W

Please follow below steps to implement PV module connection:

1. Remove insulation sleeve 10 mm for positive and negative conductors.
2. Check correct polarity of connection cable from PV modules and PV input connectors. Then, connect positive pole (+) of connection cable to positive pole (+) of PV input connector. Connect negative pole (-) of connection cable to negative pole (-) of PV input connector.

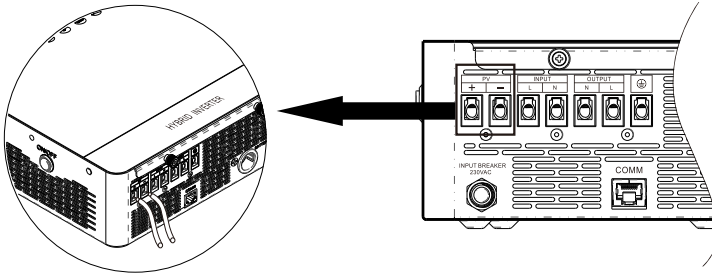
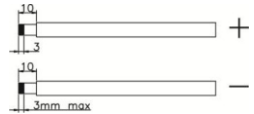

3. Make sure the wires are securely connected.

**Final Assembly**

After connecting all wirings, please put bottom cover back by screwing two screws as shown below.

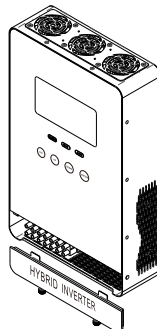

# OPERATION

## Power ON/OFF

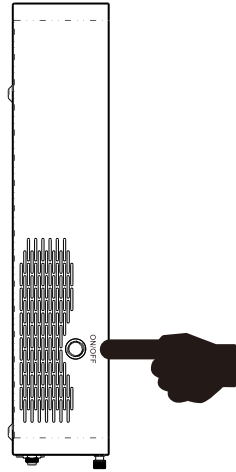

Once the unit has been properly installed and the batteries are connected well, simply press On/Off switch (located on the button of the case) to turn on the unit.

## Operation and Display Panel

The operation and display panel, shown in below chart, is on the front panel of the inverter. It includes three indicators, four function keys and a LCD display, indicating the operating status and input/output power information.

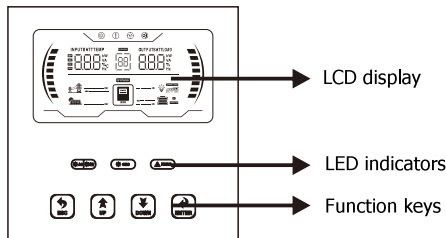

### LED Indicator

LED Indicator		Messages	
☀️ AC ⚡️ INV	Green	Solid On	Output is powered by utility in Line mode.
		Flashing	Output is powered by battery or PV in battery mode.
☀️ CHG	Green	Solid On	Battery is fully charged.
		Flashing	Battery is charging.
⚠️ FAULT	Red	Solid On	Fault occurs in the inverter.
		Flashing	Warning condition occurs in the inverter.

### Function Keys

Function Key	Description
ESC	To exit setting mode
UP	To go to previous selection
DOWN	To go to next selection
ENTER	To confirm the selection in setting mode or enter setting mode



# LCD Display Icons

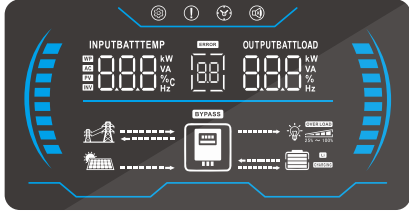

Icon	Function description	
<b>Input Source Information</b>		
	Indicates the AC input.	
	Indicates the PV input	
	Indicate input voltage, input frequency, PV voltage, battery voltage and charger current.	
<b>Configuration Program and Fault Information</b>		
	Indicates the setting programs.	
	Indicates the warning and fault codes.	
	Warning:  flashing with warning code.	
	Fault:  lighting with fault code	
<b>Output Information</b>		
	Indicate output voltage, output frequency, load percent, load in VA, load in Watt and discharging current.	
<b>Battery Information</b>		
	Left side flashing bar and battery icon Indicates battery level by 0-20%, 20-40%,40-60% and 80-100% in battery mode and charging status in line mode.	
In AC mode, it will present battery charging status.		
Status	Battery voltage	LCD Display
Constant Current mode / Constant Voltage mode	<2V/cell	4 bars will flash in turns.
	2 ~ 2.083V/cell	Bottom bar will be on and the other three bars will flash in turns.
	2.083 ~ 2.167V/cell	Bottom two bars will be on and the other two bars will flash in turns.
	> 2.167 V/cell	Bottom three bars will be on and the top bar will flash.
Floating mode. Batteries are fully charged.		4 bars will be on.

In battery mode, it will present battery capacity.

Load Percentage	Battery Voltage	LCD Display
Load >50%	< 1.717V/cell	
	1.717V/cell ~ 1.8V/cell	
	1.8 ~ 1.883V/cell	
	> 1.883 V/cell	
50%> Load > 20%	< 1.817V/cell	
	1.817V/cell ~ 1.9V/cell	
	1.9 ~ 1.983V/cell	
	> 1.983	
Load < 20%	< 1.867V/cell	
	1.867V/cell ~ 1.95V/cell	
	1.95 ~ 2.033V/cell	
	> 2.033	

### Load Information

<b>OVER LOAD</b>	Indicates overload.			
	Right side flashing bar and load icon Indicates the load level by 0-24%,25-50%, 50-75% and 75-100%.			
	0%~25%	25%~50%	50%~75%	75%~100%

### Mode Operation Information

	Indicates unit connects to the mains.
	Indicates unit connects to the PV panel.
<b>BYPASS</b>	Indicates load is supplied by utility power.
	Indicates the utility charger circuit is working.
	Indicates the DC/AC inverter circuit is working.

### Mute Operation

	Indicates unit alarm is disabled.
--	-----------------------------------

# LCD Setting

After pressing and holding ENTER button for 3 seconds, the unit will enter setting mode. Press "UP" or "DOWN" button to select setting programs. And then, press "ENTER" button to confirm the selection or ESC button to exit.

## Setting Programs:





Program	Description	Selectable option	
00	Exit setting mode	Escape 00 <u>ESC</u>	
01	Output source priority: To configure load power source priority	01 <u>SUB</u>	Solar energy provides power to the loads as first priority. If solar energy is not sufficient to power all connected loads, utility energy will supply power to the loads at the same time.
		01 <u>SBU</u>	Solar energy provides power to the loads as first priority. If solar energy is not sufficient to power all connected loads, battery energy will supply power to the loads at the same time. Utility provides power to the loads only when battery voltage drops to either low-level warning voltage or the setting point in program 13.
02	Maximum charging current To configure total charging current for solar and utility chargers. (Max. charging current = utility charging current + solar charging current)	10A 02 <u>10<sup>A</sup></u>	20A 02 <u>20<sup>A</sup></u>
		30A 02 <u>30<sup>A</sup></u>	40A 02 <u>40<sup>A</sup></u>
		50A 02 <u>50<sup>A</sup></u>	60A 02 <u>60<sup>A</sup></u>
		70A 02 <u>70<sup>A</sup></u>	80A 02 <u>80<sup>A</sup></u>
		90A 02 <u>90<sup>A</sup></u>	100A 02 <u>100<sup>A</sup></u>
		110A 02 <u>110<sup>A</sup></u>	150A 02 <u>150<sup>A</sup></u>

03	AC input voltage range	Appliances 03 <u>APL</u>	If selected, acceptable AC input voltage range will be within 90-265VAC.
		UPS (default) 03 <u>UPS</u>	If selected, acceptable AC input voltage range will be within 170-265VAC.
04	Power saving mode enable/disable	Saving mode disable (default) 04 <u>SdS</u>	If disabled, no matter connected load is low or high, the on/off status of inverter output will not be effected.
		Saving mode enable 04 <u>SEn</u>	If enabled, the output of inverter will be off when connected load is pretty low or not detected.
05	Battery type	AGM (default) 05 <u>AGn</u>	Flooded 05 <u>FLd</u>
		Lithium ion battery 05 <u>LIB</u>	After setting to "LIB", the floating charge will be cancelled.
		User-Defined 05 <u>USE</u>	If "User-Defined" is selected, battery charge voltage and low DC cut-off voltage can be set up in program 26, 27 and 29.
06	Auto restart when overload occurs	Restart disable (default) 06 <u>Ltd</u>	Restart enable 06 <u>LtE</u>
07	Auto restart when over temperature occurs	Restart disable 07 <u>ltD</u>	Restart enable (default) 07 <u>ltE</u>
08	Output voltage	220V 08 <u>220</u> <sub>v</sub>	230V (default) 08 <u>230</u> <sub>v</sub>
		240V 08 <u>240</u> <sub>v</sub>	The setting range is 100-240V, non-professionals should not set it by themselves, otherwise it will cause serious consequences
09	Output frequency	50Hz (default) 09 <u>50</u> <sub>Hz</sub>	60Hz 09 <u>60</u> <sub>Hz</sub>

10	On-Grid	On-Grid enable 10 <u>ON</u>	On-Grid disable(default) 10 <u>OFF</u>
		non-professionals should not set it by themselves, otherwise it will cause serious consequences	
11	Maximum utility charging current	150A 11 <u>150A</u>	10A 11 <u>10A</u>
		20A 11 <u>20A</u>	30A 11 <u>30A</u>
		40A 11 <u>40A</u>	50A 11 <u>50A</u>
		60A 11 <u>60A</u>	70A 11 <u>70A</u>
		80A 11 <u>80A</u>	
12	Set the battery charging cut-off current.	2A 12 <u>2A</u>	5A 12 <u>5A</u>
		10A(default) 12 <u>10A</u>	20A 12 <u>20A</u>

13	Setting voltage point back to utility source when selecting "SBU priority"	Available options in 24V models:			
		22.0V 13 <u>22.0</u> <sup>BATT</sup> v	22.5V 13 <u>22.5</u> <sup>BATT</sup> v		
		23.0V 13 <u>23.0</u> <sup>BATT</sup> v	23.5V 13 <u>23.5</u> <sup>BATT</sup> v		
		24.0V 13 <u>24.0</u> <sup>BATT</sup> v	24.5V 13 <u>24.5</u> <sup>BATT</sup> v		
		25.0V 13 <u>25.0</u> <sup>BATT</sup> v	25.5V 13 <u>25.5</u> <sup>BATT</sup> v		
		27.0V (default) 13 <u>27.0</u> <sup>BATT</sup> v			
		Available options in 48V models:			
		44V 13 <u>44</u> <sup>BATT</sup> v	45V 13 <u>45</u> <sup>BATT</sup> v		
		46V (default) 13 <u>46</u> <sup>BATT</sup> v	47V 13 <u>47</u> <sup>BATT</sup> v		
		48V 13 <u>48</u> <sup>BATT</sup> v	49V 13 <u>49</u> <sup>BATT</sup> v		
		50V 13 <u>50</u> <sup>BATT</sup> v	51V 13 <u>51</u> <sup>BATT</sup> v		
		14	Parallel operation (only available for parallel models)	Parallel operation function enable 14 <u>ON</u>	Parallel operation function disable 14 <u>OFF</u>
				Set to phase A of three-phase 15 <u>A</u>	Set to phase B of three-phase 15 <u>b</u>
15	Setting parallel phase sequence (available only for parallel models)	Set to phase C of three-phase 15 <u>C</u>			

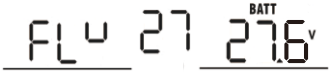
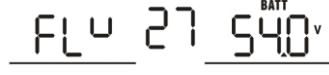
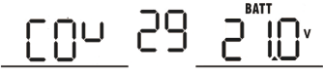
16	Charger source priority: To configure charger source priority	If this inverter/charger is working in Line, Standby or Fault mode, charger source can be programmed as below:	
		Solar first 16 <u>CS0</u>	Solar energy will charge battery as first priority. Utility will charge battery only when solar energy is not available.
		Solar and Utility 16 <u>SNU</u>	Solar energy and utility will charge battery at the same time.
		Only Solar 16 <u>OSO</u>	Solar energy will be the only charger source no matter utility is available or not.
		If this inverter/charger is working in Battery mode or Power saving mode, only solar energy can charge battery. Solar energy will charge battery if it's available and sufficient.	
17	For factory use only		
18	Alarm control	Alarm on (default) 18 <u>6ON</u>	Alarm off 18 <u>6OF</u>
19	Auto return to default display screen	Return to default display screen (default) 19 <u>ESP</u>	If selected, no matter how users switch display screen, it will automatically return to default display screen (Input voltage /output voltage) after no button is pressed for 1 minute.
		Stay at latest screen 19 <u>1EP</u>	If selected, the display screen will stay at latest screen user finally switches.
20	Backlight control	Backlight on (default) 20 <u>LON</u>	Backlight off 20 <u>LOF</u>
22	Beeps while primary source is interrupted	Alarm on 22 <u>AON</u>	Alarm off (default) 22 <u>AOF</u>
25	Record Fault code	Record enable (default) 25 <u>FEN</u>	Record disable 25 <u>FdS</u>

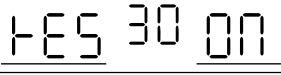
26	Bulk charging voltage (C.V voltage)	24V model default setting: 28.2V 
		48V model default setting: 56.4V 
		If self-defined is selected in program 5, this program can be set up. Setting range is from 24.0V to 29.2V for 24V model and 48.0V to 58.4V for 48V model. Increment of each click is 0.1V.
27	Floating charging voltage	24V model default to 27.0V 
		48V model default setting: 54.0V 
		If self-defined is selected in program 5, this program can be set up. Setting range is from 24.0V to 29.2V for 24V model, 48.0V to 58.4V for 48V model. Increment of each click is 0.1V.
29	Low DC cut-off voltage	24V model default setting: 21.0V 
		48V model default setting: 42.0V 
		If self-defined is selected in program 5, this program can be set up. Setting range is from 20.0V to 24.0V for 24V model, 40.0V to 48.0V for 48V model. Increment of each click is 0.1V. Low DC cut-off voltage will be fixed to setting value no matter what percentage of load is connected.
30	Restore default settings	Restore default settings 
		If this option is selected, the Inverter will restore the default settings



33	Battery equalization	<u>EQ 33</u> <u>ON</u>	<u>EQ 33</u> <u>OFF</u>
		If "Flooded" or "User-Defined" is selected in program 05, this program can be set up.	
34	Battery equalization voltage	1KVA default setting:14.6V <u>EQ</u> <u>34</u> <u>14.6</u> <sup>BATT</sup> V	
		Setting range is from 12.5V to 15 V. Increment of each click is 0.1V.	
		4. 5KW default setting: 29.2V <u>EQ</u> <u>34</u> <u>29.2</u> <sup>BATT</sup> V	
		Setting range is from 25.0V to 29.5V. Increment of each click is 0.1V.	
		6. 5KW default setting:58.4V <u>EQ</u> <u>34</u> <u>58.4</u> <sup>BATT</sup> V	
Setting range is from 50 to 59 V.Increment of each click is 0.1V.			
35	Battery equalized time	60min (default) <u>35</u> <u>60</u>	Setting range is from 5min to 900min. Increment of each click is 5min.
36	Battery equalized timeout	120min (default) <u>36</u> <u>120</u>	Setting range is from 5min to 900 min. Increment of each click is 5 min.
37	Equalization interval	30days (default) <u>37</u> <u>30d</u>	Setting range is from 0 to 90 days. Increment of each click is 1 day
39	Equalization activated immediately	Enable <u>39</u> <u>ON</u>	Disable (default) <u>39</u> <u>OFF</u>
		If equalization function is enabled in program 33, this program can be set up. If "Enable" is selected in this program, it's to activate battery equalization immediately and LCD main page will shows "EQ". If "Disable" is selected, it will cancel equalization function until next activated equalization time arrives based on program 37 setting. At this time, "EQ" will not be shown in LCD main page.	

# Display Setting



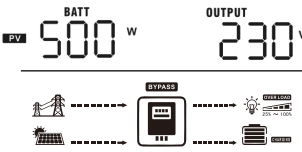
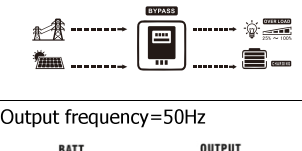
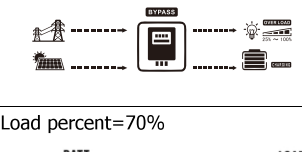
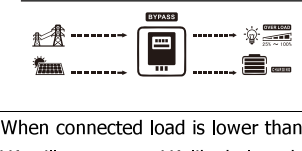
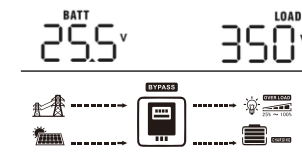
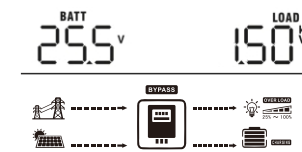

The LCD display information will be switched in turns by pressing “UP” or “DOWN” key. The selectable information is switched as below order: input voltage, input frequency, PV voltage, MPPT charging current, MPPT charging power, battery voltage, output voltage, output frequency, load percentage, load in VA, load in Watt, DC discharging current, main CPU Version.

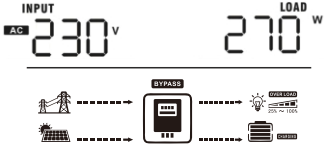
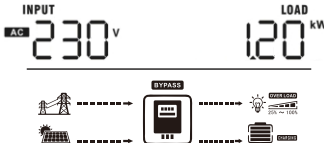
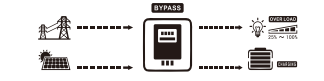







Selectable information	LCD display
Input voltage/Output voltage (Default Display Screen)	<p>Input Voltage=230V, output voltage=230V</p>
Input frequency	<p>Input frequency=50Hz</p>
PV voltage	<p>PV voltage=360V</p>
MPPT Charging current	<p>Current <math>\cong</math> 10A</p> <p>Current &lt; 10A</p>

MPPT Charging power	<p>MPPT charging power=500W</p> 
Battery voltage/ DC discharging current	<p>Battery voltage=25.5V, discharging current=1A</p> 
Output frequency	<p>Output frequency=50Hz</p> 
Load percentage	<p>Load percent=70%</p> 
Load in VA	<p>When connected load is lower than 1kVA, load in VA will present xxxVA like below chart.</p>  <p>When load is larger than 1kVA, load in VA will present x.xkVA like below chart.</p> 

<p>Load in Watt</p>	<p>When load is lower than 1kW, load in W will present xxxW like below chart.</p>  <p>When load is larger than 1kW, load in W will present x.xkW like below chart.</p> 
<p>Main CPU version checking</p>	<p>Main CPU version 00014.04</p> 

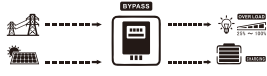
## Operating Mode Description

Operation mode	Description	LCD display
<p>Standby mode / Power saving mode</p> <p><b>Note:</b></p> <p>*Standby mode: The inverter is not turned on yet but at this time, the inverter can charge battery without AC output.</p> <p>*Power saving mode: If enabled, the output of inverter will be off when connected load is pretty low or not detected.</p>	<p>No output is supplied by the unit but it still can charge batteries.</p>	<p>Charging by utility and PV energy.</p>  <p>Charging by utility.</p>  <p>Charging by PV energy.</p>  <p>No charging.</p> 

<p>Fault mode</p> <p>Note:</p> <p>*Fault mode: Errors are caused by inside circuit error or external reasons such as over temperature, output short circuited and so on.</p>	<p>PV energy and utility can charge batteries.</p>	<p>Charging by utility and PV energy.</p>  <p>Charging by utility.</p>  <p>Charging by PV energy.</p>  <p>No charging.</p> 
<p>Line Mode</p>	<p>The unit will provide output power from the mains. It will also charge the battery at line mode.</p> <p>The unit will provide output power from the mains. It will also charge the battery at line mode.</p>	<p>Charging by utility and PV energy.</p>  <p>Charging by utility.</p>  <p>If "SUB" is selected as output source priority and solar energy is not sufficient to provide the load, solar energy and the utility will provide the loads and charge the battery at the same time.</p>  <p>If "SUB" is selected as output source priority and battery is not connected, solar energy and the utility will provide the loads.</p>  <p>Power from utility.</p> 

Battery Mode	The unit will provide output power from battery and PV power.	Power from battery and PV energy.
		PV energy will supply power to the loads and charge battery at the same time.
		Power from battery only.
		Power from PV energy only.

**SBU mode:**

In the "SBU" mode, when the solar energy is not available, the battery will complement the utility to supply the load together. With the change of the battery voltage, the Energy Rubik's Cube will intelligently adjust the discharge current of the battery.

To activate the Energy Rubik's Cube, the first setting has to be "SBU", and then set the battery voltage point back to utility source of 13th setting according to the characteristics of the battery

When the solar energy is not available, AC output source will be intelligently adjusted according to the below chart

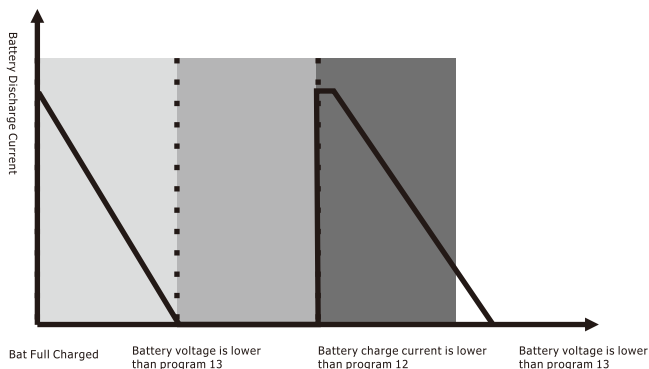

## Battery Equalization Description

Equalization function is added into charge controller. It reverses the buildup of negative chemical effects like stratification, a condition where acid concentration is greater at the bottom of the battery than at the top. Equalization also helps to remove sulfate crystals that might have built up on the plates. If left unchecked, this condition, called sulfation, will reduce the overall capacity of the battery. Therefore, it's recommended to equalize battery periodically.

- **How to Apply Equalization Function**

You must enable battery equalization function in monitoring LCD setting program 33 first. Then, you may apply this function in device by either one of following methods:

1. Setting equalization interval in program 37.
2. Active equalization immediately in program 39.

- **When to Equalize**

In float stage, when the setting equalization interval (battery equalization cycle) is arrived, or equalization is active immediately, the controller will start to enter Equalize stage.

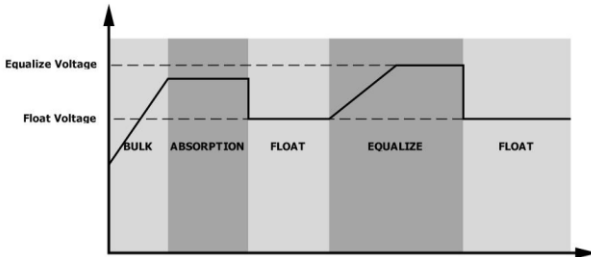

- **Equalize charging time and timeout**

In Equalize stage, the controller will supply power to charge battery as much as possible until battery voltage raises to battery equalization voltage. Then, constant-voltage regulation is applied to maintain battery voltage at the battery equalization voltage. The battery will remain in the Equalize stage until setting battery equalized time is arrived.

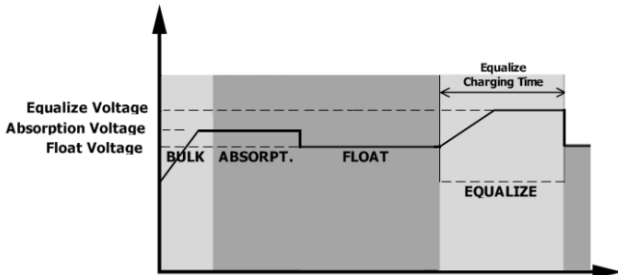

However, in Equalize stage, when battery equalized time is expired and battery voltage doesn't rise to battery equalization voltage point, the charge controller will extend the battery equalized time until battery voltage achieves battery equalization voltage. If battery voltage is still lower than battery equalization voltage when battery equalized timeout setting is over, the charge controller will stop equalization and return to float stage.

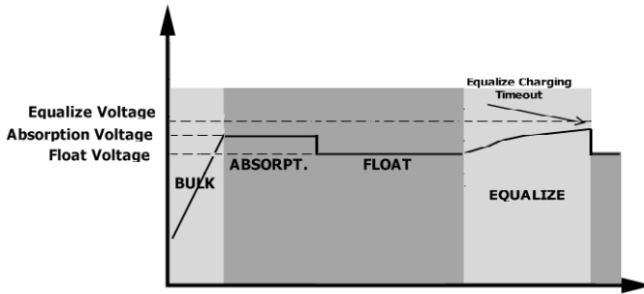









## Fault Reference Code

Fault Code	Fault Event	Icon on
01	Fan is locked when inverter is off.	
02	Over temperature	
03	Battery voltage is too high	
04	Battery voltage is too low	
05	Output short circuited or over temperature is detected by internal converter components.	
06	Output voltage is too high.	
07	Overload time out	
08	Bus voltage is too high	
09	Bus soft start failed	
11	Main relay failed	
51	Over current or surge	
52	Bus voltage is too low	
53	Inverter soft start failed	
55	Over DC voltage in AC output	
56	Battery connection is open	
57	Current sensor failed	
58	Output voltage is too low	



# Warning Indicator

Warning Code	Warning Event	Audible Alarm	Icon flashing
01	Fan is locked when inverter is on.	Beep twice every second	
03	Battery is over-charged	Beep twice every second	
04	Low battery	Beep twice every second	
07	Overload	Beep twice every second	
10	Output power derating	Beep twice every second	
12	Solar charger stops due to low battery.		
13	Solar charger stops due to high PV voltage.		
14	Solar charger stops due to overload.		
15	PV is weak		

# SPECIFICATIONS

Table 1 Line Mode Specifications

INVERTER MODEL	4.5KW 24V	6.5KW 48V
<b>Input Voltage Waveform</b>	Sinusoidal (utility or generator)	
<b>Nominal Input Voltage</b>	230Vac	
<b>Low Loss Voltage</b>	170Vac±7V (UPS) 90Vac±7V (Appliances)	
<b>Low Loss Return Voltage</b>	180Vac±7V (UPS); 100Vac±7V (Appliances)	
<b>High Loss Voltage</b>	265Vac±7V	
<b>High Loss Return Voltage</b>	255Vac±7V	
<b>Max AC Input Voltage</b>	300Vac	
<b>Nominal Input Frequency</b>	50Hz / 60Hz (Auto detection)	
<b>Low Loss Frequency</b>	40±1Hz	
<b>Low Loss Return Frequency</b>	42±1Hz	
<b>High Loss Frequency</b>	65±1Hz	
<b>High Loss Return Frequency</b>	63±1Hz	
<b>Output Short Circuit Protection</b>	Line mode: Circuit Breaker Battery mode: Electronic Circuits	
<b>Efficiency (Line Mode)</b>	>95% ( Rated R load, battery full charged )	
<b>Transfer Time</b>	10ms typical (UPS); 20ms typical (Appliances)	
<p><b>Output power derating:</b> When AC input voltage drops to 95V or 170V depending on models, the output power will be derated.</p>	<p>230Vac model:</p> 	

Table 2 Inverter Mode Specifications

INVERTER MODEL	4.5KW 24V	6.5KW 48V
<b>Rated Output Power</b>	4.5KVA/4.5KW	6.5KVA/ 6.5KW
<b>Output Voltage Waveform</b>	Pure Sine Wave	
<b>Output Voltage Regulation</b>	230Vac±5%	
<b>Output Frequency</b>	60Hz or 50Hz	
<b>Peak Efficiency</b>	94%	
<b>Overload Protection</b>	5s@≥150% load; 10s@110%~150% load	
<b>Surge Capacity</b>	2* rated power for 5 seconds	
<b>Nominal DC Input Voltage</b>	24Vdc	48Vdc
<b>Cold Start Voltage</b>	23.0Vdc	46.0Vdc
<b>Low DC Warning Voltage</b>	22.0Vdc	44.0Vdc
<b>Low DC Warning Return Voltage</b>	23.0Vdc	46.0Vdc
<b>Low DC Cut-off Voltage</b>	21.0Vdc	42.0Vdc
<b>High DC Recovery Voltage</b>	29Vdc	58Vdc
<b>High DC Cut-off Voltage</b>	31Vdc	62Vdc
<b>No Load Power Consumption</b>	<35W	<50W

Table 3 Charge Mode Specifications

Utility Charging Mode		
INVERTER MODEL	4.5KW 24V	6.5KW 48V
<b>Charging Current (UPS)</b> @ Nominal Input Voltage	80A	80A
<b>Bulk Charging Voltage</b>	<b>Flooded Battery</b>	58.4
	<b>AGM / Gel Battery</b>	56.4
<b>Floating Charging Voltage</b>	27Vdc	54Vdc
<b>Charging Algorithm</b>	3-Step	
<b>Charging Curve</b>	<p>The graph plots Battery Voltage (per cell) on the left y-axis and Charging Current (%) on the right y-axis against Time on the x-axis. The voltage curve (black) rises linearly in the Bulk stage, plateaus in the Absorption stage, and then slightly drops in the Maintenance stage. The current curve (red) is constant at 100% in the Bulk stage, then decays exponentially in the Absorption stage, and reaches 0% in the Maintenance stage. Key voltage points are 2.43V/cell (12.30V/48V) and 2.25V/cell. Time intervals T0 and T1 are marked, with T1 = 10 * T0, minimum 10mins, maximum 8hrs.</p>	

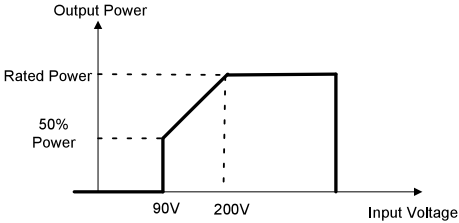
Solar Charging Mode		
INVERTER MODEL	4.5KW 24V	6.5KW 48V
<b>Rated Power</b>	6000W	6500W
<b>PV Charge Current</b>	150A	130A
<b>Efficiency</b>	98.0% max.	
<b>Max. PV Array Open Circuit Voltage</b>	450Vdc	450Vdc
<b>PV Array MPPT Voltage Range</b>	55-450Vdc	55-450Vdc
<b>Standby Power Consumption</b>	2W	
<b>Battery Voltage Accuracy</b>	+/-0.3%	
<b>PV Voltage Accuracy</b>	+/-2V	
<b>Charging Algorithm</b>	3-Step	

Table 4 General Specifications

<b>INVERTER MODEL</b>	<b>4.5KW 24V</b>	<b>6.5KW 48V</b>
<b>Safety Certification</b>	CE	
<b>Operating Temperature Range</b>	0°C to 55°C	
<b>Storage temperature</b>	-15°C~ 60°C	
<b>Dimension (D*W*H), mm</b>	468*318*159mm	
<b>Net Weight, kg</b>	7.5kg	8.5kg

# TROUBLE SHOOTING

Problem	LCD/LED/Buzzer	Explanation / Possible cause	What to do
Unit shuts down automatically during startup process.	LCD/LEDs and buzzer will be active for 3 seconds and then complete off.	The battery voltage is too low (<1.91V/Cell)	1. Re-charge battery. 2. Replace battery.
No response after power on.	No indication.	1. The battery voltage is far too low. (<1.4V/Cell) 2. Battery polarity is connected reversed.	1. Check if batteries and the wiring are connected well. 2. Re-charge battery. 3. Replace battery.
Mains exist but the unit works in battery mode.	Input voltage is displayed as 0 on the LCD and green LED is flashing.	Input protector is tripped	Check if AC breaker is tripped and AC wiring is connected well.
	Green LED is flashing.	Insufficient quality of AC power. (Shore or Generator)	1. Check if AC wires are too thin and/or too long. 2. Check if generator (if applied) is working well or if input voltage range setting is correct. (UPS→Appliance)
	Green LED is flashing.	Set "Solar First" as the priority of output source.	Change output source priority to Utility first.
When the unit is turned on, internal relay is switched on and off repeatedly.	LCD display and LEDs are flashing	Battery is disconnected.	Check if battery wires are connected well.
Buzzer beeps continuously and red LED is on.	Fault code 07	Overload error. The inverter is overload 110% and time is up.	Reduce the connected load by switching off some equipment.
	Fault code 05	Output short circuited.	Check if wiring is connected well and remove abnormal load.
		Temperature of internal converter component is over 120°C.	Check whether the air flow of the unit is blocked or whether the ambient temperature is too high.
	Fault code 02	Internal temperature of inverter component is over 100°C.	
	Fault code 03	Battery is over-charged.	Return to repair center.
		The battery voltage is too high.	Check if spec and quantity of batteries are meet requirements.
	Fault code 01	Fan fault	Replace the fan.
	Fault code 06/58	Output abnormal (Inverter voltage below than 190Vac or is higher than 260Vac)	1. Reduce the connected load. 2. Return to repair center
	Fault code 08/09/53/57	Internal components failed.	Return to repair center.
	Fault code 51	Over current or surge.	Restart the unit, if the error happens again, please return to repair center.
	Fault code 52	Bus voltage is too low.	
	Fault code 55	Output voltage is unbalanced.	
Fault code 56	Battery is not connected well or fuse is burnt.	If the battery is connected well, please return to repair center.	

## Appendix: Approximate Back-up Time Table

Model	Load (W)	Backup Time @ 24Vdc 100Ah (min)	Backup Time @ 24Vdc 200Ah (min)
4.5KW	300	449	1100
	600	222	525
	900	124	303
	1200	95	227
	1500	68	164
	1800	56	126
	2100	48	108
	2400	35	94
	2700	31	74
	3200	28	67

Model	Load (W)	Backup Time @ 48Vdc 100Ah (min)	Backup Time @ 48Vdc 200Ah (min)
6.5KW	500	613	1288
	1000	268	613
	1500	158	402
	2000	111	271
	2500	90	215
	3200	76	182
	3500	65	141
	4000	50	112
	4500	44	100
	5000	40	90

**Note:** Backup time depends on the quality of the battery, age of battery and type of battery.  
 Specifications of batteries may vary depending on different manufacturers.

**\* Product technical specifications are subject to change without notice.**



# POWMr

SHENZHEN HEHEJIN INDUSTRIAL CO.,LTD

Tel/Fax: +86 755-28219903

Email: [Support@powmr.com](mailto:Support@powmr.com)

Web: [www.powmr.com](http://www.powmr.com)

Add: Henggang Street, Longgang District, Shenzhen, Guangdong, China



技术要求:

- 1: 材质:封面: 105克铜板纸 、内页: 80克书写纸, 黑白印刷;
- 2: 装订后成品尺寸:142.5\*210mm(公差+/-2MM);
- 3: 印刷效果:图片、字体、线条需清晰,无重影, 无毛边, 无多余杂点;