

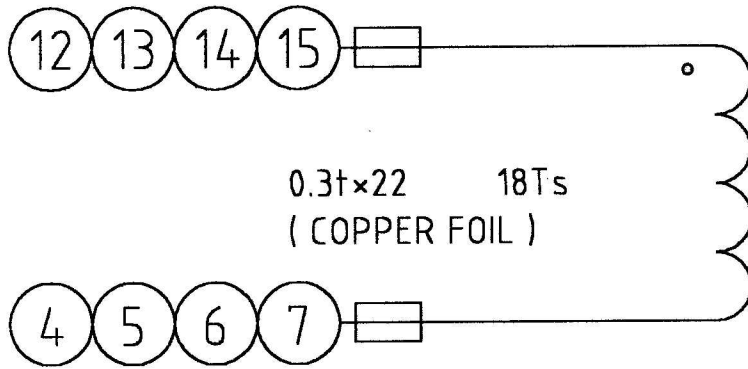

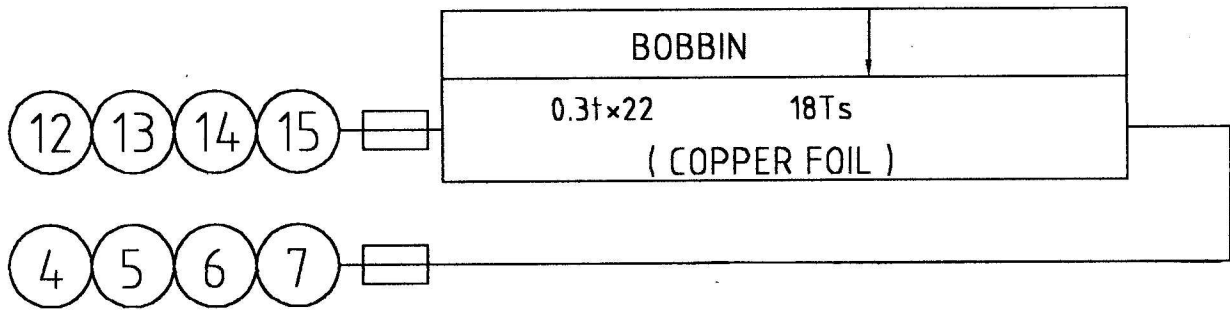



1. SCHEMATICS.



2. WINDING SEQUENCE.



(SLEEVED WITH 0.3t MALAR FILM) #92

CUSTOMER: R.C.S.(烏克蘭)		APPROVED BY: 
PART NO. ETD 39-2	ISSUE: A	CHECKED BY: 
 	DATE: 2004.06.03.	DRAWN BY: 
	力英電子股份有限公司 LI TONE ELECTRONICS CO., LTD. 台北縣三峽鎮介壽路1段311巷29號 NO. 29, LANE 311, JIE SOU RD., SEC 1. SANHSIA TOWN TAIPEI HSIEN, TAIWAN R. O. C.	
		TEL: (02)2673-2512~6 FAX: 886-2-26710294 886-2-26736329





3.MATERIAL LIST.

NO/ITEM	MATERIAL	MAKER
3-1.CORE	ETD-39 FERRITE CORE. PC40.	TDK.
3-2.BOBBIN	ETD-39 H. TYPE W / 16 PINS PHENOLIC / T375J. YW-148.	CHANG CHUN PLASTICS CO.,LTD. UL NO.E59481(S). YIH HWA BOBBIN ENTRPRISES CO.,LTD.
3-3.WIRE	COPPER FOIL (0.35t×22mm)	
3-4.MYLAR FILM	M021/105°C. (0.05 t×26mm)	E.I.DUPONT DE NEMOURS & CO.,INC. UL NO.E93687(R)
3-5.TAPE	POLYESTER TAPE. #92.	MINNESOTA MINING & MFG.CO.(3M). UL NO.E17385.
3-6.TUBING	PTFE / TFL / 150V	GREAT HOLDING IND CO, LTD. UL NO.E156256
3-7.VARNISH	VIKING V1630FS.	UNDERWOOD INDUSTRIES OF NEW YORK INC. UL NO.E60614
3-8.EPOXY	9001A / 9001B.	SHAW HUOW ENTERPRISE CO., LTD. UL NO.E105888.
3-9.CLIP	ETD-39 HIGH CARBON STEEL.	SHEN SHEN INDUSTRIAL CO, LTD.

4.ELECTRICAL SPECIFICATION.

4-1.INDUCTANCE. (P12,13,P14,15-P4,5,6,7) 22uH±10%. @1 KHZ 0.25V HP-4284A

4-2.D.C.RESISTANCE. (P12,13,P14,15-P4,5,6,7) 0.012Ω MAX. GOM-801G

CUSTOMER: R.C.S.(烏克蘭)		APPROVED BY: 
PART NO. ETD39-2	ISSUE: A	CHECKED BY: 
 	DATE: 2004.05.31.	DRAWN BY: 
	力英電子股份有限公司 LI TONE ELECTRONICS CO., LTD. 台北縣三峽鎮介壽路1段311巷29號 NO. 29, LANE 311, JIE SOU RD., SEC 1. SANHSIA TOWN TAIPEI HSIEN, TAIWAN R. O. C.	

5.CONFIGURATION & DIMENSION.(UNIT:mm)

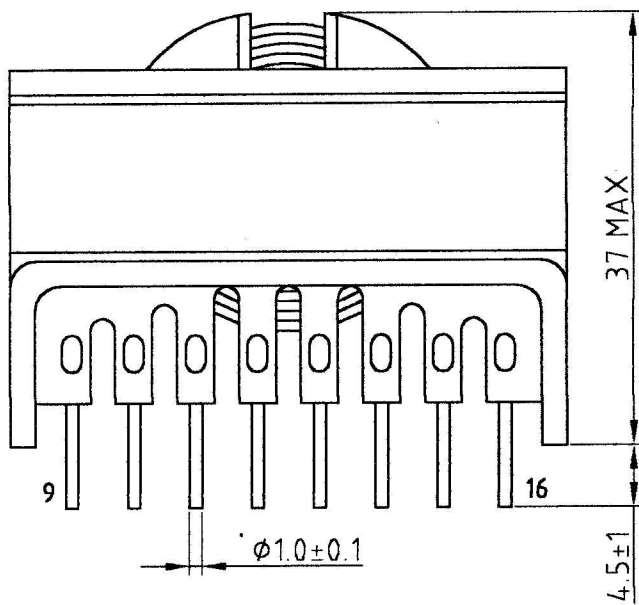

(FRONT VIEW)

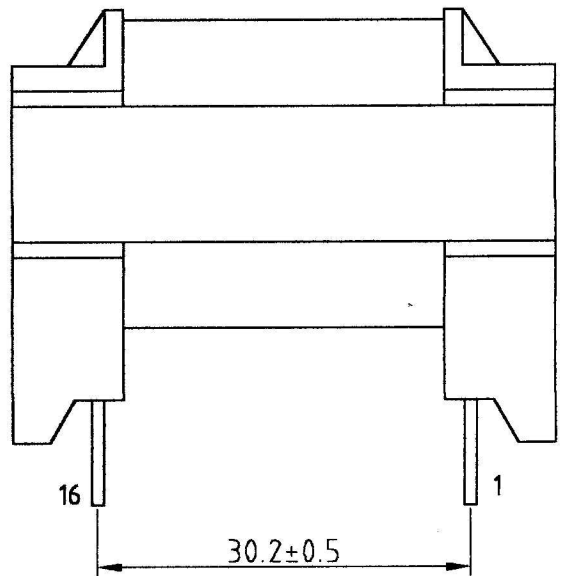



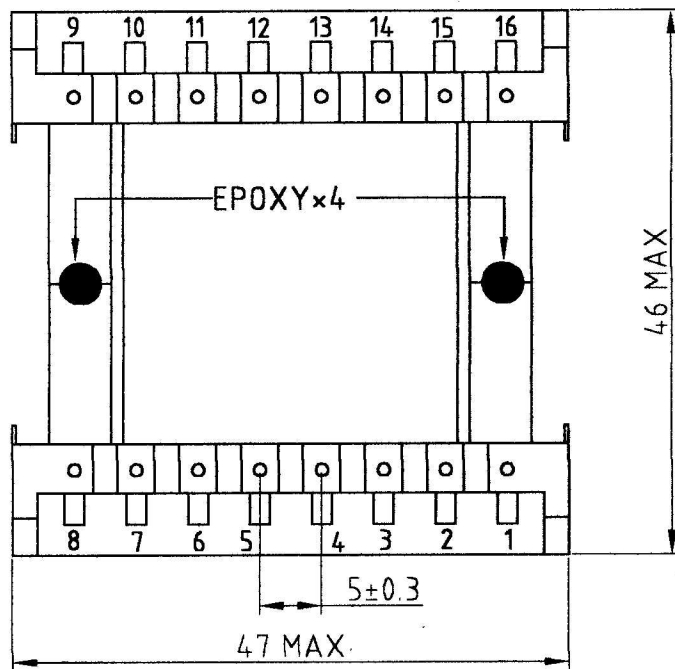

(SIDE VIEW)

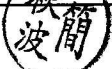

(BOTTOM VIEW)

MAKE PIN 1 WITH WHITE DOT.
*PIN 1, 8 CUT OFF.

*MARKING (P1-P8):
ETD39-2
LTE YYWW

CUSTOMER: R.C.S.(烏克蘭)		APPROVED BY: 
PART NO. ETD 39-2	ISSUE: A	CHECKED BY: 
DATE: 2004.05.31.		DRAWN BY: 
 		TEL: (02)2673-2512~6
力英電子股份有限公司 LI TONE ELECTRONICS CO., LTD. 台北縣三峽鎮介壽路1段311巷29號 NO. 29, LANE 311, JIE SOU RD., SEC 1. SANHSIA TOWN TAIPEI HSIEN, TAIWAN R. O. C.		FAX: 886-2-26710294 886-2-26736329