

Epoxy-coated Solid Electrolytic Tantalum Capacitors (LEAD FREE)

TCR Series (LEAD FREE)

HITANO

1. Scope

This specification applies to Epoxy-coated Solid Electrolytic Tantalum Capacitors (LEAD FREE).

2. Product identification

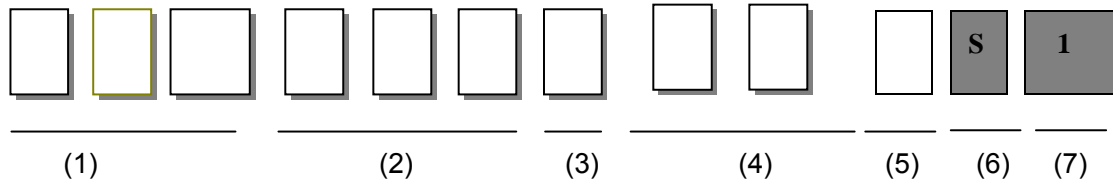

Part no. Designation:

- (1)series: TCR represent series number of epoxy-coated solid electrolytic tantalum capacitors
- (2)capacitance code: Capacitance expressed in micro farad ,1st two digits represent significant figures and 3rd digit represents multiplier(number of zeros to follow). Dot will be marked as 'R'
- (3)capacitance tolerance: Capacitance tolerance code is listed as follows:

Allowable Tolerance Code of the Capacitance

Allowable Tolerance%	Tolerance Code
±5	J
±10	K
±20	M

- (4)Rated DC voltage: Rated DC voltage Code is expressed in two digits. Example as under:
4V = 0G, 6.3V = 0J, 10 = 10V, 16 = 16V, 20 = 20V, 25 = 25V, 35 = 35V, 50 = 50V
- (5)Packing style: Packaging Code : B: Bulk. R: Tape and Reel. A: Ammo Pack
- (6)Lead length Code : S = short lead cut to 5mm length. L = Long straight
- (7)Lead Space: 1 = 2.5mm, 2=5.0mm (Standard pitch follow the size table except Taped type)

3. The range of the specification

table I

Nominal cap. Range	0.047~330μF								
capacitance tolerance	±20% or ±10%								
Rated voltage(VR)	4V	6.3V	10V	16V	20V	25V	35V	50V	
Surge voltage(VS)	5.2V	8V	13V	20V	26V	33V	46V	65V	
Temperature range	-55°C ~ +125°C								
The life test	1000Hr								

Epoxy-coated Solid Electrolytic Tantalum Capacitors (LEAD FREE)

TCR Series (LEAD FREE)

HITANO

4. Temperature characteristic

1	leakage current	0.01CV or 0.5 μ A (whichever is greater)	Series protective resistor:1000 Ω Measuring voltage: rated voltage Measuring time:1minutes
2	Capacitance Tolerance	$\pm 20\%$, $\pm 10\%$	Measurement circuit: Equivalent series circuit
3	Tangent of loss angle (tan δ)	$\leq 1.0\mu\text{F}:\leq 0.04$ $1.5\sim 6.8\mu\text{F}:\leq 0.06$ $10\sim 68\mu\text{F}:\leq 0.08$ $100\sim 330\mu\text{F}:\leq 0.1$	Measuring frequency:120Hz $\pm 10\%$ Measuring voltage max.:0.5Vrms,+1.5Vdc.

Table II

Cap. (μF)	Change in cap. (%)			DF max. (%)				DCL max. (μA)		
	-55 $^{\circ}\text{C}$	+85 $^{\circ}\text{C}$	+125 $^{\circ}\text{C}$	-55 $^{\circ}\text{C}$	+20 $^{\circ}\text{C}$	+85 $^{\circ}\text{C}$	+125 $^{\circ}\text{C}$	+20 $^{\circ}\text{C}$	+85 $^{\circ}\text{C}$	+125 $^{\circ}\text{C}$
≤ 1.0	± 10	± 15	± 25	6	4	6	6	I _o =0.01CV or 0.5 μA (whichever is greater)	10 I _o	12.5 I _o
1.5~6.8				8	6	8	8			
10~68				10	8	10	10			
100~330				12	10	12	12			

5. Appearance & Dimensions

5.1 Appearance & Dimensions

(Fig. 5.1)

Table III (unit: mm)

case size	D($\pm 0.5\text{mm}$)	H($\pm 0.5\text{mm}$)	F($\pm 0.5\text{mm}$)	d
A	4.5	7.0	2.5	0.5
B	5.0	8.0	2.5	0.5
C	5.5	9.5	2.5	0.5
D	6.5	11.0	2.5	0.5
E	8.5	13.0	5.0	0.5
F	9.5	16.5	5.0	0.5

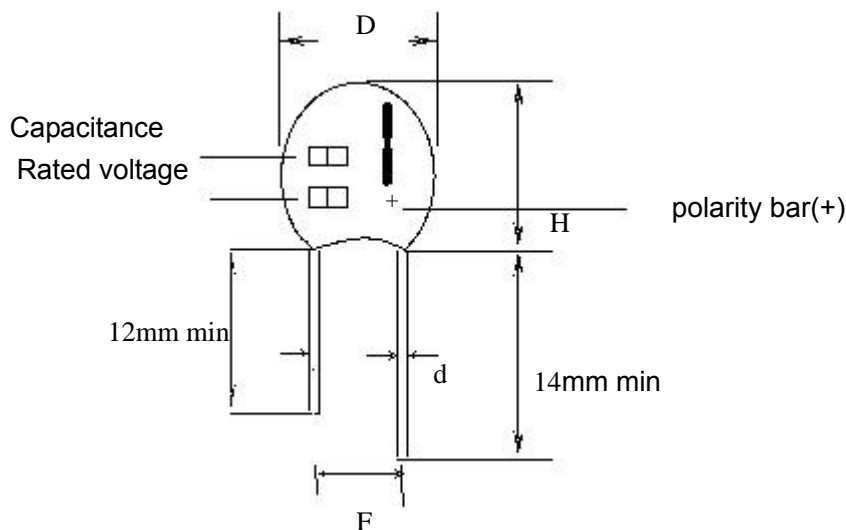

Fig. 5.1

(other lead styles are available upon request)

Epoxy-coated Solid Electrolytic Tantalum Capacitors (LEAD FREE)

TCR Series (LEAD FREE)

HITANO

6. Marking

Fig. 5.1, capacitance, DC voltage and polarity(+) are laser marked on the capacitor body

7. The range of the capacitance and case

(letter expresses case)

table IV

Capacitance (μF)	4V	6.3 V	10 V	16V	20V	25V	35V	50V
0.047							A	A
0.068							A	A
0.1							A	A
0.15							A	A
0.22							A	A
0.33							A	A
0.47							A	A
0.68							A	A
1.0				A	A	A	A	B
1.5				A	A	A	A	C
2.2			A	A	A	A	B	C
3.3		A	A	A	B	B	B	D
4.7	A	A	A	B	B	B	C	D
6.8	A	A	B	B	C	C	D	E
10	A	B	B	B	C	C	D	E
15	A	B	C	C	D	D	E	F
22	B	C	C	C	D	D	E	F
33	B	C	D	D	E	E	F	
47	C	D	D	D	E	E	F	
68	D	D	D	E	F	F		
100	D	E	E	E	F	F		
150	E	E	E	F				
220	E	E	F					
330	F	F						

Epoxy-coated Solid Electrolytic Tantalum Capacitors (LEAD FREE)

TCR Series (LEAD FREE)

HITANO

8. Reliable performance

Items	Performance characteristics			Conditions of test				
(1) Characteristics at high and low temperature	Step	Performance characteristics		Step	Temperature	Duration		
	1	Change in cap.	See table II	1:	+20°C±2	-	30min	30min
		Tangent of loss angle (tanδ)						
	2	Change in cap.						
		Tangent of loss angle (tanδ)						
		Leakage current						
	3	Change in cap.						
		Tangent of loss angle (tanδ)	S.V.	4.6	7.25	11.5	18.4	
		Leakage current	R.V.	20	25	35	50	
			S.V.	23	28.2	40.2	57.5	
(2) Surge test	Change in cap.	Relative to the Value before test ±10%	Temperature: 85±2°C protective series resistor: 1000Ω 1000cycles. charge time :30±5s discharge time: 5min 30s [Measuring voltage(R.V): surge voltage(S.V)]					
	Tangent of loss angle (tanδ)	See table II DF max						
	Leakage current	See table II DCL max						
	Appearance	There shall be no such mechanical damage						
(3) Resistance to soldering heat	Appearance	No visible damage The marking shall be legible.	Test method Solder temperature: 260±5°C Dip duration: 5±0.5s					
(4) Solderability	A new uniform coating of solder shall cover the surface being immersed		Test method Solder temperature: 235±5°C Dip duration: 2±0.5s					
(5) Vibration	Appearance	No visible damage	The entire frequency range: 10 to 55Hz Amplitude: 0.35mm Duration: 3×0.5h					
(6) Damp heat	Change in cap.	Relative to value before test ±12%	Test temp: 40±2°C Humidity: 90-95%R.H Test time: 10 days No voltage applied Recovery: 1-2hours					
	Tangent of loss angle(δ)	See table II DF max						
	Leakage current	See table II DCL max						
	Appearance	No visible damage The marking shall be legible						

Epoxy-coated Solid Electrolytic Tantalum Capacitors (LEAD FREE)

TCR Series (LEAD FREE)

HITANO

(7)Electrical endurance	Change in cap.	Relative to value before test $\pm 10\%$	1.Test temp: $85^{\circ}\text{C}\pm 2^{\circ}\text{C}$ Test time:1000 hours Voltage: Rated voltage 2.Test temp: $125^{\circ}\text{C}\pm 2^{\circ}\text{C}$ Test time:1000 hours Voltage: Derated voltage Recovery:16 hours [(R.V)Measuring voltage: (D.V)Derated voltage]				
	Tangent of loss angle(δ)	See table II DF max					
	Leakage current	See table II DCL max $\times 1.25$					
	Appearance	No visible damage The marking shall be legible					
			R.V.	4	6.3	10	16
			S.V.	2.5	4.7	6.3	10
			R.V.	20	25	35	50
			S.V.	13	16	20	32

9. The Lead-free product identifying label

For identify lead-free product, our company will attach the lead-free label “



”on the packaging.

10. Typical Characteristic curve

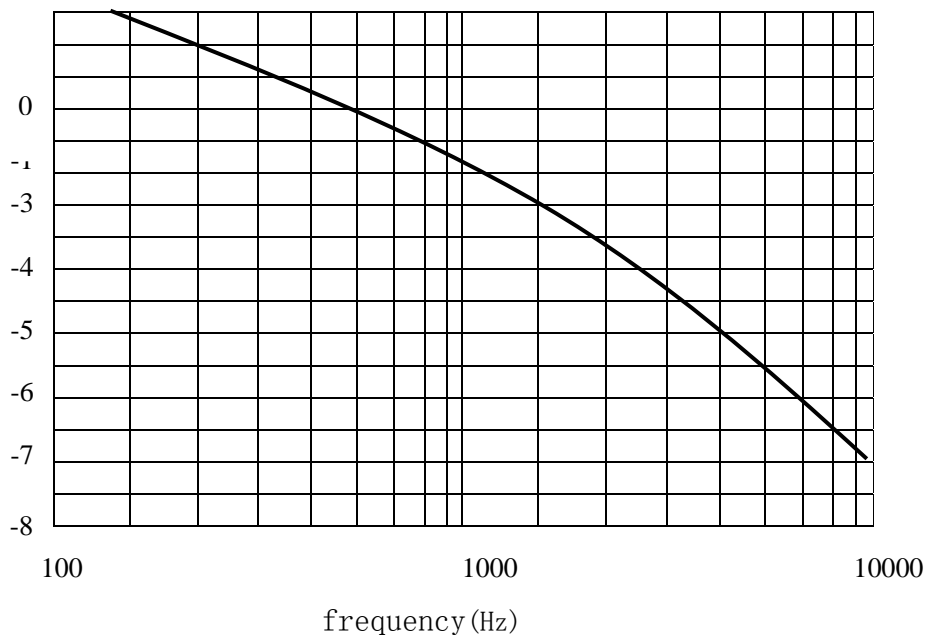

9.1 Capacitance change vs frequency

Epoxy-coated Solid Electrolytic Tantalum Capacitors (LEAD FREE)

TCR Series (LEAD FREE)

HITANO

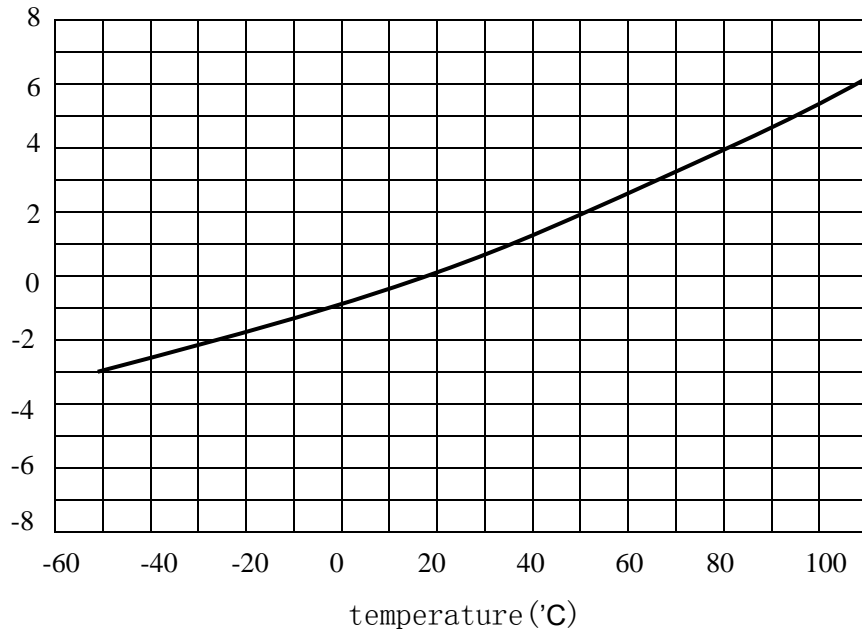

9.2 capacitance change vs temperature

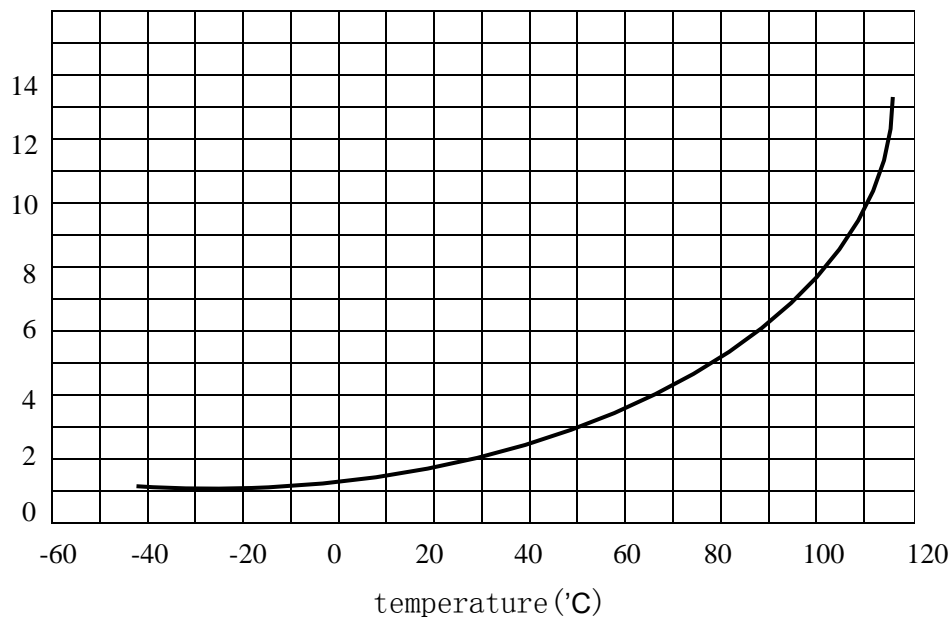

9.3 Leakage current vs temperature

Epoxy-coated Solid Electrolytic Tantalum Capacitors (LEAD FREE)

TCR Series (LEAD FREE)

HITANO

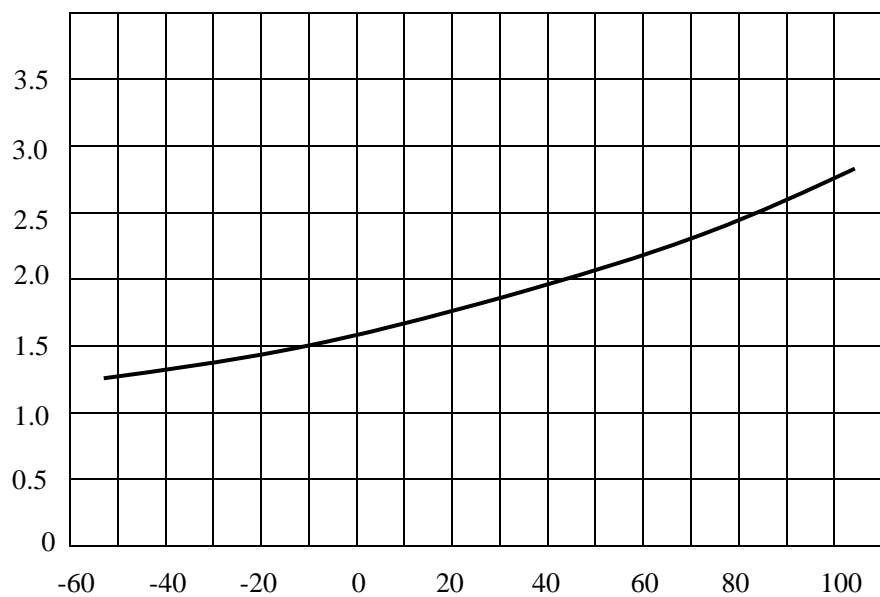

temperature(°C)

9.4 Tangent of loss angle vs temperature

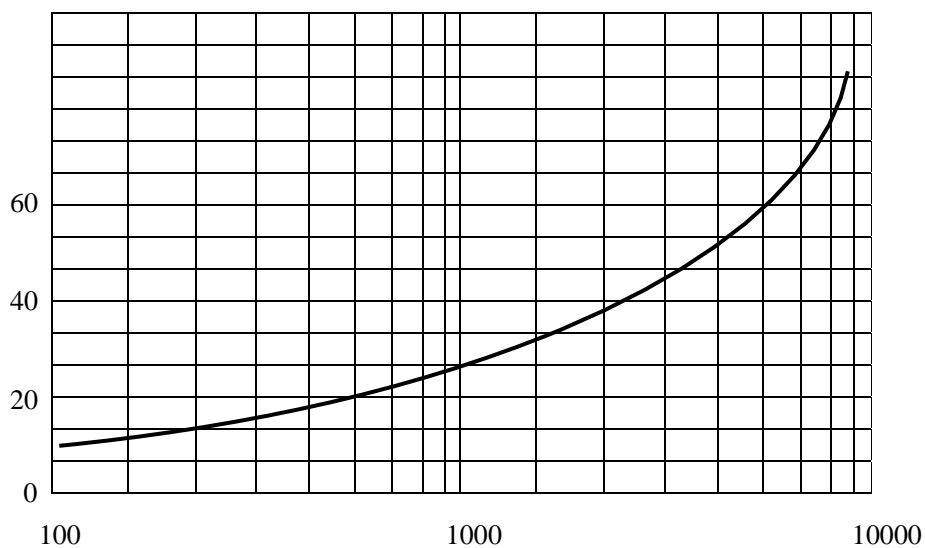

frequency (Hz)

9.5 Tangent of loss angle vs frequency

Epoxy-coated Solid Electrolytic Tantalum Capacitors (LEAD FREE)

TCR Series (LEAD FREE)

HITANO

11. Packing

11.1 Taping

11.1.1 Taping dimension

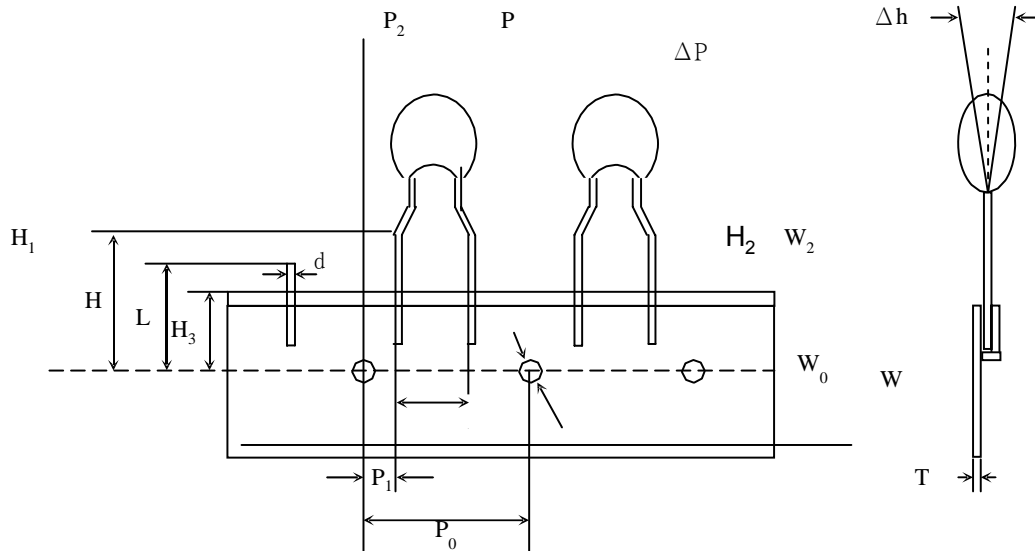

Symbol	Dimension (mm)	
P	12.7±1.0	
P ₀	12.7±0.3	
W	18 ⁺¹ _{10.5}	
W ₀	12±0.5	
H ₃	9 ^{+0.75} _{10.5}	
W ₂	3max.	
H ₁	32.5max	
ΔP	±1.3max	
D	4.0±0.3	
T	0.5±0.2	
Δh	±2max	
L	11max	
H	16±0.5	
S	2.5±0.5	5±0.5
P ₁	5.10±0.5	3.85±0.7
P ₂	6.35±0.4	
H ₂	18-22	
d	0.5±0.05	

Epoxy-coated Solid Electrolytic Tantalum Capacitors (LEAD FREE)

TCR Series (LEAD FREE)

HITANO

11.1.2 TAPPING PACKAGING

1) SCOPE

This specification covers the requirements for TCR series type resin-coated tantalum capacitor(lead free).

2) PACKING MATERIAL

ITEM	SUBSTANCE
CARTON BOX	CORRUGATED PAPER
PACKING CTN	CORRUGATED PAPER
PASTEBOARD	THICK CRAFT PAPER
PLASTIC BAG	COMMON WHITE PLASTIC BAG
HOT MELTING TAPE	CREPE PAPER AND RUBBER ADHESIVE

3) PACKING UNIT

a) The capacity of packing ctn.

Every carton contains 10 packing box.

b) Every packing box contain quantity as follow:

CASE	QUANTITY(PCS)
A	2500
B/ C	2000
D /E /F	1000

4) THE SHAPE AND DIMENSION OF PACKING BOX

Unit : mm

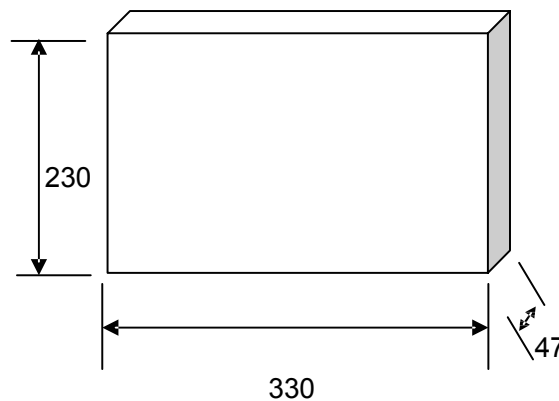

5) THE PACKING METHOD

a) At the beginning and the end of TAPPING there is 3 more pitches of vacuum goods.

b) When the TAPPING packs, every 25pcs has a fold line, besides the fold line there is half of pitch of vacuum goods.

6) STORAGE

Have the products keeping in constant temperature and constant humidity. Storage time is two years after manufacturing.

7) LABEL OF PACKING CTN

Every packing ctn has a piece of label.

Epoxy-coated Solid Electrolytic Tantalum Capacitors (LEAD FREE)

TCR Series (LEAD FREE)

HITANO

11.2 Bulk

Packing product in plastic bag

A/B/C case: 1000pcs per bag

D/E case: 500pcs per bag

F case: 250pcs per bag

12. The method of mounting

Recommend the method of mounting: the capacitor directly insets PCB when it is used. The body and the lead are steadied in the application of the vibration and shock tests, the distance between the body and the mounting point shall be $6\pm 1\text{mm}$.

Recommended Soldering condition: The TCR lead-free product generally uses wave soldering.

Pre-heating: $150^{\circ}\text{C}\pm 15^{\circ}\text{C}$ /60-90s

Max. peak gradient: $2.5^{\circ}\text{C} /\text{s}$

The peak temperature is 250°C - 260°C for 3-5s

Time at $>230^{\circ}\text{C}$:40s Max.

13. Note in use

13.1 For circuits with low resistance circuit, make the use voltage be 1/3 or under of the rated voltage; in general circuit, make the use voltage be 1/2 or under of the rated voltage.

13.2 In case of circuits with large instantaneous rush current or rapid charging/discharging circuits, connect the protection resistor of $3\Omega/v$ or more in series to the capacitor to limit the current to 300mA or less. when the protection resistor can not be inserted, lower the use voltage to 1/3 or under of the rated voltage .

13.3 Use the capacitors within the permissible ripple voltage specified independently. Use in the range that the sum of the DC voltage value and the peak value of ripple voltage does not exceed the rated voltage. Design not to apply over voltage made by fluctuation of superimposed DC voltage or reverse voltage to the capacitors.

13.4 Use the capacitors within the specified use temperature range. In case use temperature exceeds $+85^{\circ}\text{C}$, apply the reduced voltage shown in the below figure as the rated voltage.

13.5 environmental conditions

do not use the equipment fit with the capacitor in the below environment.

- Environment where capacitors are directly splashed with water, salt water and oil.
- Environment where capacitors are directly exposed to sunlight.
- Environment in high temperature and humidity causing dewing on capacitor surface.
- Environment where capacitors touch various active gases.
- Acid and alkaline atmosphere.
- Environment with high frequency induction.
- Environment with excessive vibration and shock..

Epoxy-coated Solid Electrolytic Tantalum Capacitors (LEAD FREE)

TCR Series (LEAD FREE)

HITANO

14. Storage

14.1 storage condition

environmental temperature: -10°C - $+40^{\circ}\text{C}$

relative humidity: no more than 70%

14.2 storing period

No more than one and half year since date of stocking.