

# MICRO INVERTER



## WVC-1200(Life) USER MANUAL

..... Green Energy  
..... Smart Inverter **Expert** .....

### IoT Monitoring Platform Smart mobile "core" life

- CO-2 induced environmental analysis
- Daily and total energy generation in kWh
- Actual DC input voltage, current and power
- Actual AC output voltage, current and power
- Inverter temperature
- Historical (daily, weekly, monthly) power curve
- Power losses due to weather induced effects
- Optional limitation of power output
- Online switch for the inverter start stop

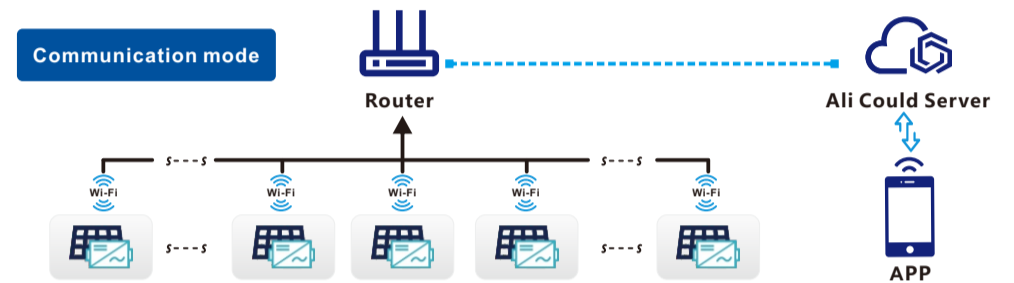

- ☑ CO-2 induced environmental analysis
- ☑ Daily and total energy generation in kWh
- ☑ Actual DC input voltage, current and power
- ☑ Actual AC output voltage, current and power
- ☑ Inverter temperature
- ☑ Optional limitation of power output
- ☑ Online switch for the inverter start stop
- ☑ Historical (daily, weekly, monthly) power curve

<b>model</b>	<b>WVC-1200</b>	
Recommend use panels	4*375Watt	
Output voltage mode	120/230V	
PV Open circuit voltage	33-60VDC	
Operating voltage range	22-60V	
Starting voltage range	22-60V	
short-circuit current	4*14A	
Maximum working current	4*12A	
<b>Output parameters</b>	<b>@120V</b>	<b>@230V</b>
Output peak power	1200Watt	1200Watt
Rated output power	1150Watt	1150Watt
Output current	10A	5.22A
AC voltage range	85-160VAC	180-265VAC
AC frequency range	48-51Hz/58-61Hz	48-51Hz/58-61Hz
Power factor	>95%	>95%
Number of branch connections.	3PCS ( Single )	6PCS ( Single )
<b>Output efficiency</b>	<b>@120V</b>	<b>@230V</b>
Static MPPT efficiency	99.5%	99.5%
Max output efficiency	95%	95%
Loss of power at night	<0.5W	<0.5W
Total current harmonics	<5%	<5%
<b>Appearance and technical features</b>		
Temperature range	-20°C to +50°C	
Size ( L×W×H )	370mm×300mm×41.6mm	
Net amount	3.0kg	
Waterproof grade	Ip65 NEMA3R	
Heat dissipation mode	Self-cooling	
Communication mode	Wi-Fi	
Power transmission mode	Reverse transmission, Load priority	
monitoring system	APP	
Electromagnetic Detection	EN61000-6-1:2007 EN6100-6-3:2007+A1:2011+AC:2012	
Power Grid standard	EN50549-1、EN 50549-2、NBR 16149:2013、UL1741	
Power grid detection	IEC/EN 62109-1、IEC/EN 62109-2、IEC 62116、IEEE 1547	
Certificate	CE , CEC , ETL	
<b>Packing weight</b>		
Specifications	Each ( Packing )	Box ( 4PCS )
weight	4.0KG	15.5KG
Size	430×375×140mm	430×405×380mm

### Detailed



Exterior

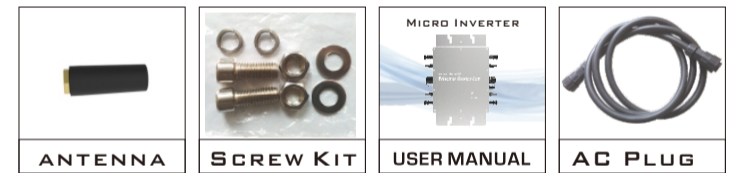

Accessories

### System diagram

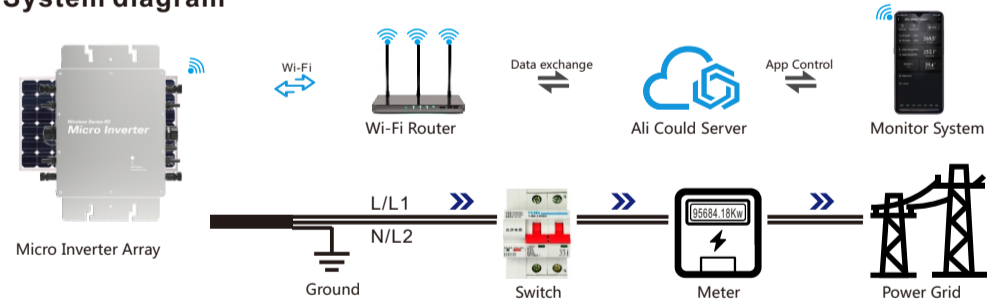

#### With N wire connection (Single phase 120/230V)

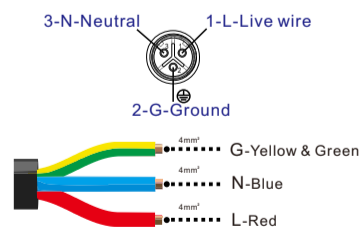

#### No N wire connection (Single phase 120V)

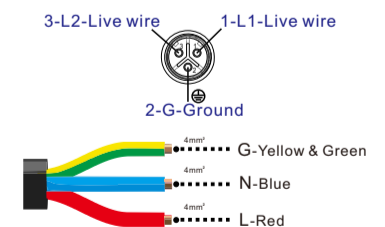

**Note:** You can purchase a professionally customized AC bus with a T-type connector. Use this AC bus as the AC bus for each branch. Connect it hand in hand to form a modular micro-inverter branch wiring system.



**When the inverter is not started/shutdown and has been connected to the grid, the status of the LED indicators is as follows**

- 1) When the inverter is not working ----- Red light is always on
- 2) When the inverter is in working state ----- Blue light flashes (MPPT is locked to a long light state)



**When the inverter is not started/shutdown and is not connected to the grid, the LED indicator status is as follows**

- 1) When the inverter is not working ----- Red light flashes
- 2) When the inverter is in working state ----- Blue light flashes (MPPT is locked in a long light state), and the red light flashes once every three seconds

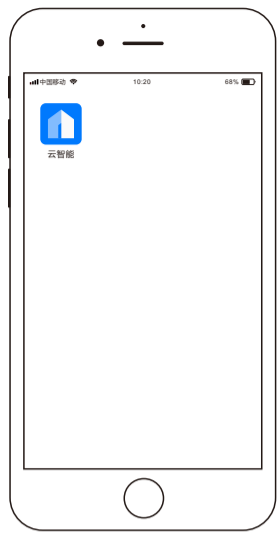

# DOWNLOAD Cloud Intelligence APP

Please use the QR code to scan and install the "Cloud Intelligence" client application, System version: Android 5.0, IOS 9 and above



## Note

Please strictly observe the following installation conditions

- Connect the communication antenna on the inverter;
- Install the inverter in a place where the Wifi signal is well covered;
- The connected Wi-Fi network needs to be in 2.4G communication mode;
- If the WiFi signal cannot effectively cover the inverter, an additional WiFi signal booster can be installed;
- Turn on the Bluetooth of the mobile phone;

## Features

Smart APP can realize real-time data transmission with the cooperation of Alibaba Cloud IoT. Through graphs and graphic displays in time, users can understand the operation of the power station. The user can monitor the operation and adjust the output power function of the system.

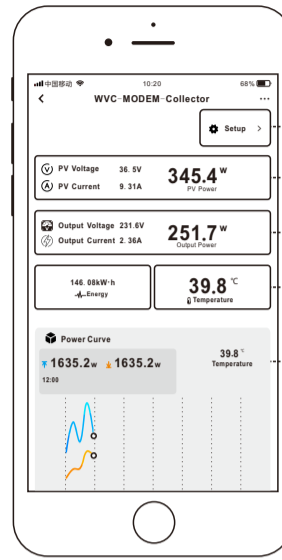

- Setup
- PV Input
- AC Output
- Temperature
- Data query

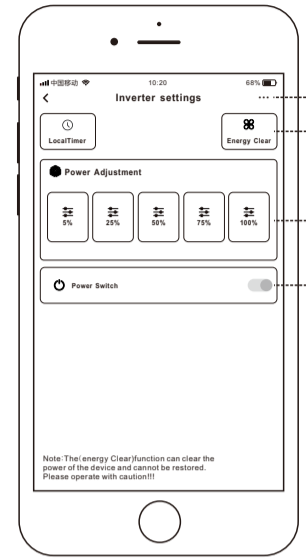

- Attributes
- Energy Clear
- Power Output
- Remote switch

## Cloud Intelligence APP



**INTELLIGENT IoT MONITORING MODEM**  
 Number of data collectors per Modem  
 Built-in WiFi IoT data terminal  
 Can be used on any smart device (Android/iOS)

- CO-2 induced environmental analysis
- Daily and total energy generation in kWh
- Actual DC input voltage, current and power
- Actual AC output voltage, current and power
- Inverter temperature
- Historical (daily, weekly, monthly) power curve
- Power losses due to weather induced effects
- Optional limitation of power output
- Online switch for the inverter start stop

## Bluetooth Mode

### Setp 1

Turn on the Bluetooth of the mobile phone, click the "+" icon to add the device;

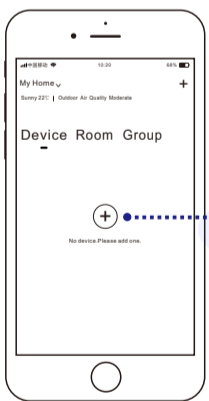

Click to add

### Setp 2

When the inverter appears on the automatic discovery page, click the "+" sign

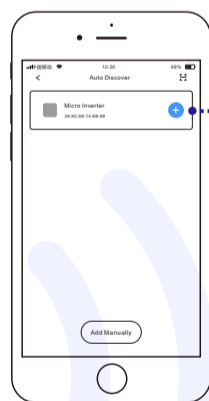

Click to add

### Setp 3

Select WiFi signal, enter the Wi-Fi password; click Next

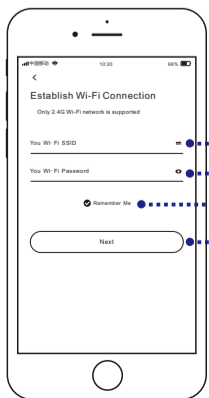

- Enter Wifi Password
- Save Password
- Next Step

### Setp 4

The system will enter the network configuration state

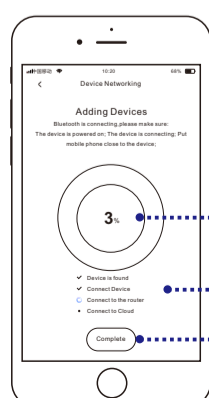

- Network progress
- Progress project
- Network completed

## Wi-Fi Mode

### Setp 1

Bluetooth distribution network fails, you can click to scan the QR code to operate

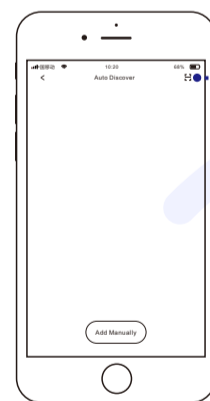

Click to add

### Setp 2

Scan the QR code on the inverter to activate network operation

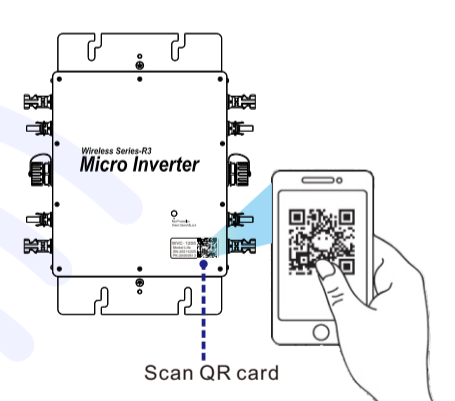

Scan QR card

### Setp 3

Select WiFi signal, enter the Wi-Fi password; click Next

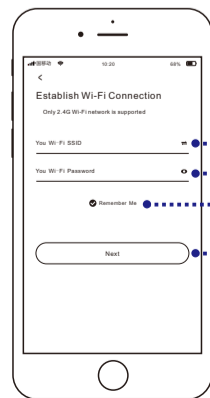

- Enter Wifi Password
- Save Password
- Next Step

### Setp 4

The system will enter the network configuration state

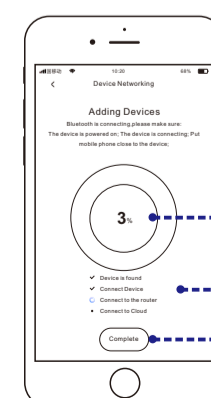

- Network progress
- Progress project
- Network completed