

|   |             |                            |
|---|-------------|----------------------------|
| Model produktu  | <b>Z-84</b> |                            |
| Format:   | <b>A4</b>   | Materiał: Polystyrene (PS) |
| Skala:  | <b>1:1</b>  | Tolerancja: +/- 0.1        |
|  <b>KRADEX</b><br>ul. Naddnieprzańska 32<br>04-205 Warszawa<br>Tel: +48 022 613-08-88, Fax: 812-10-68<br>www.kradex.com.pl |             |                            |

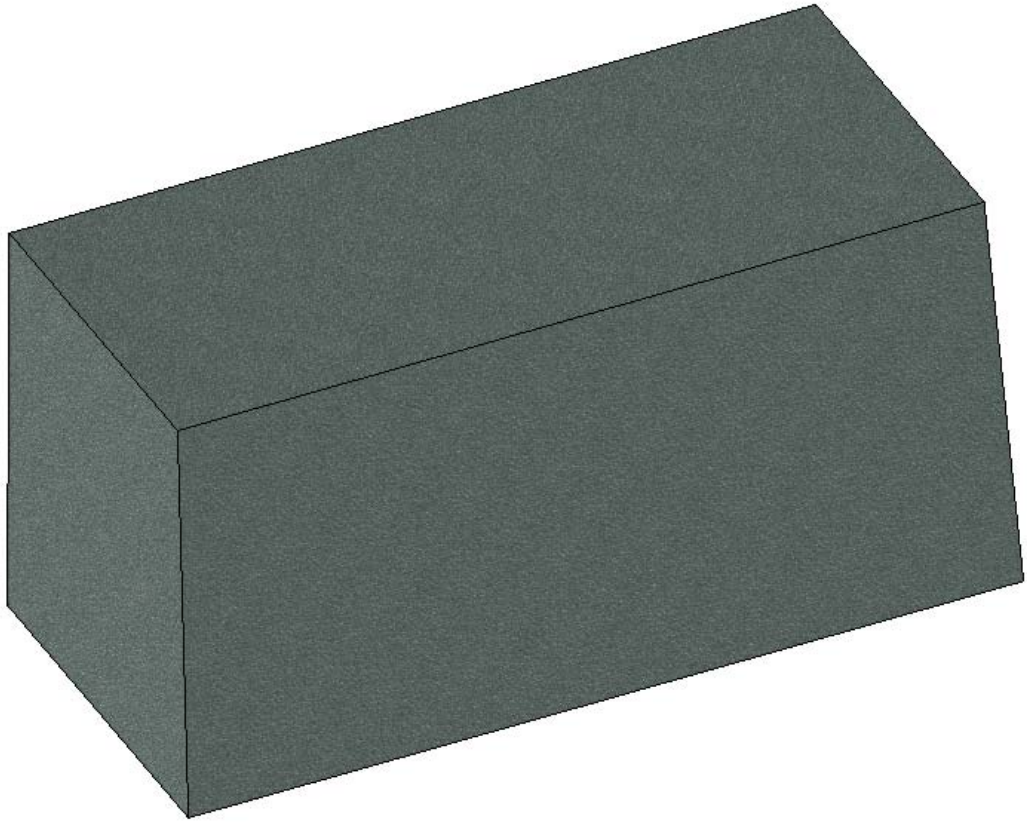

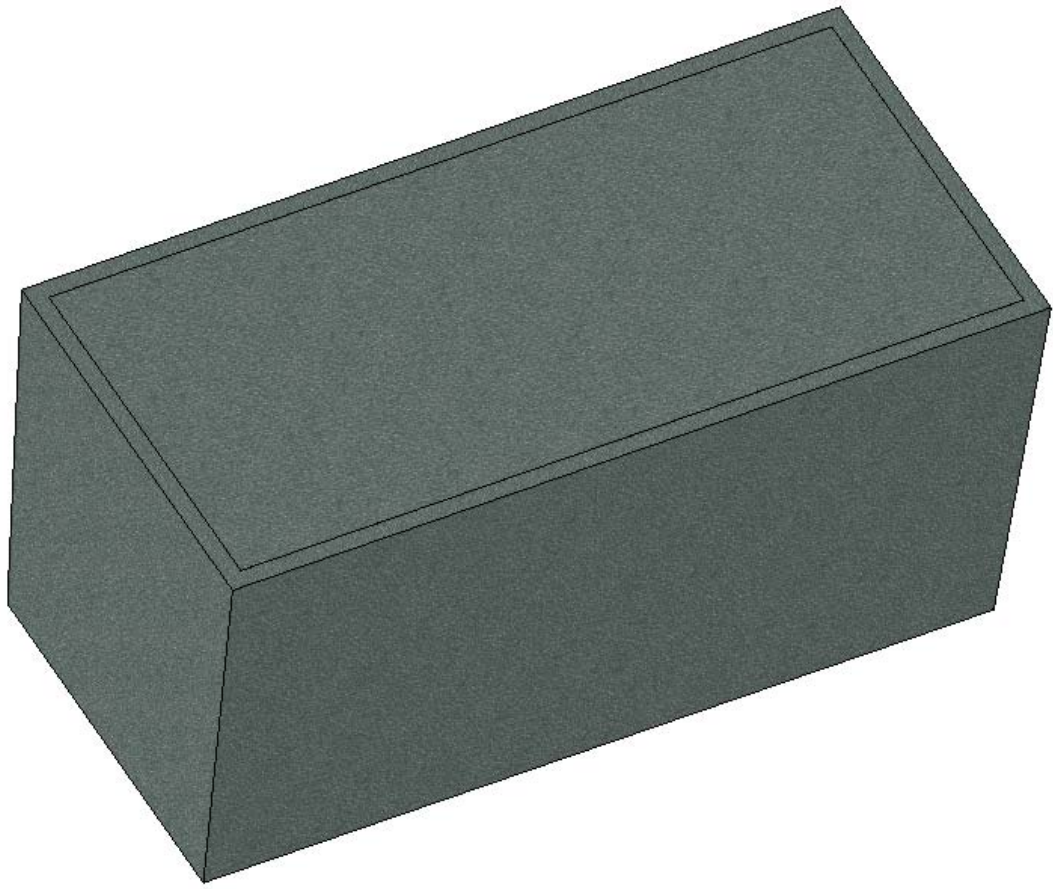

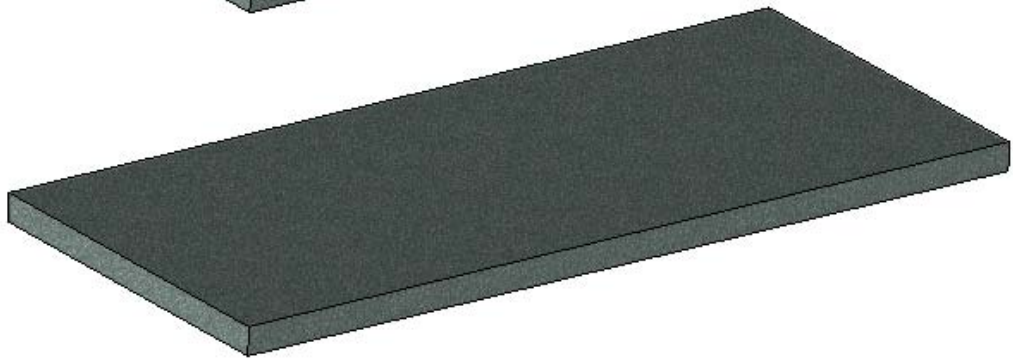

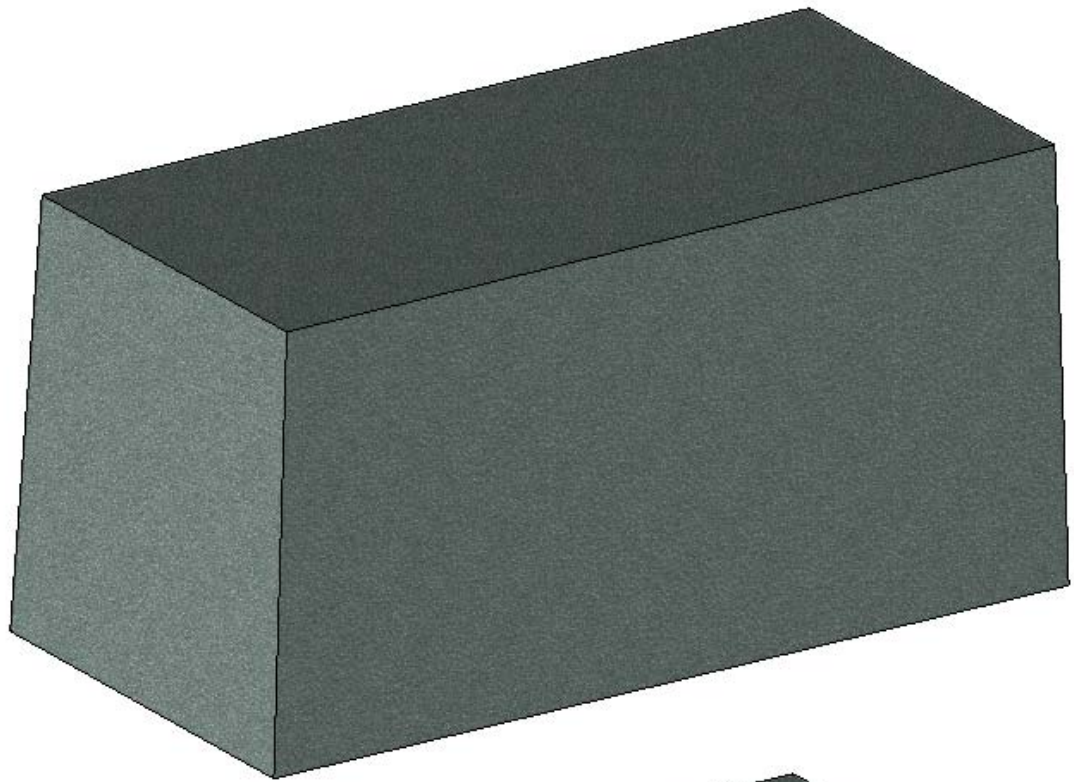

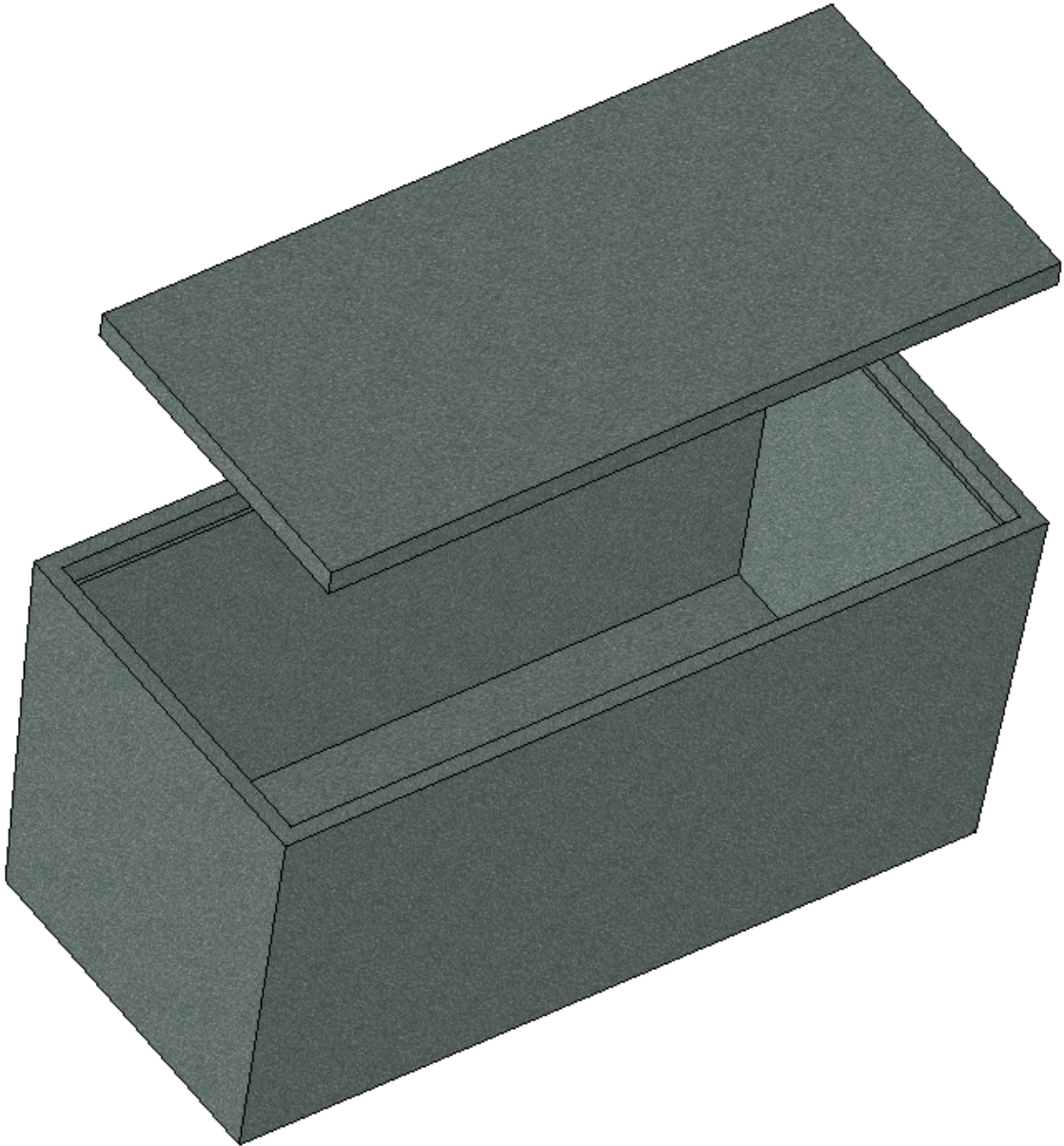

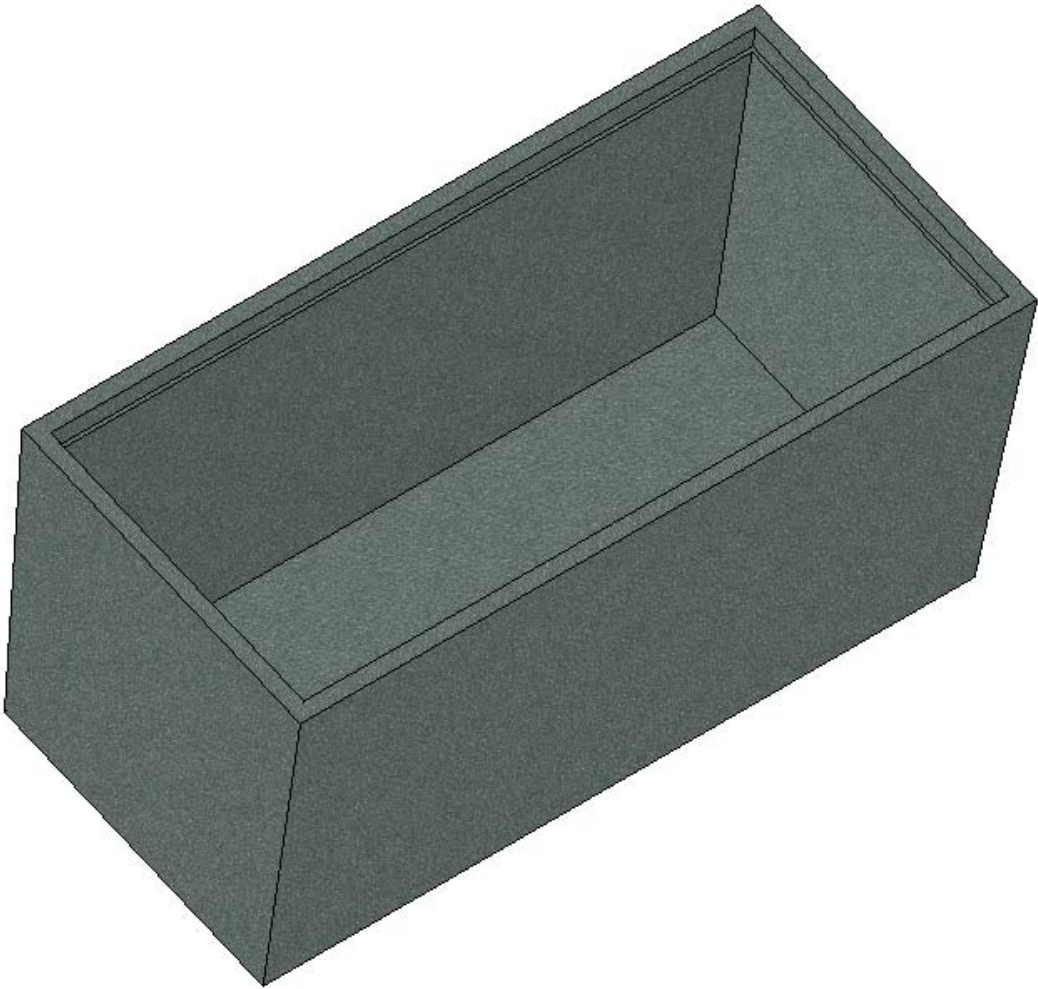

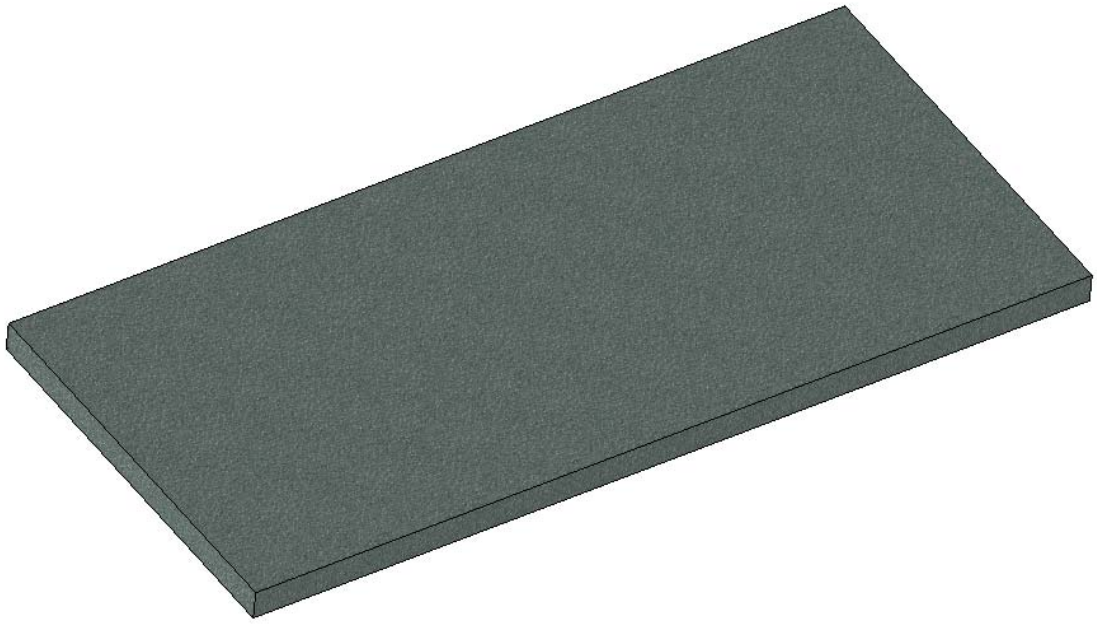

A - A

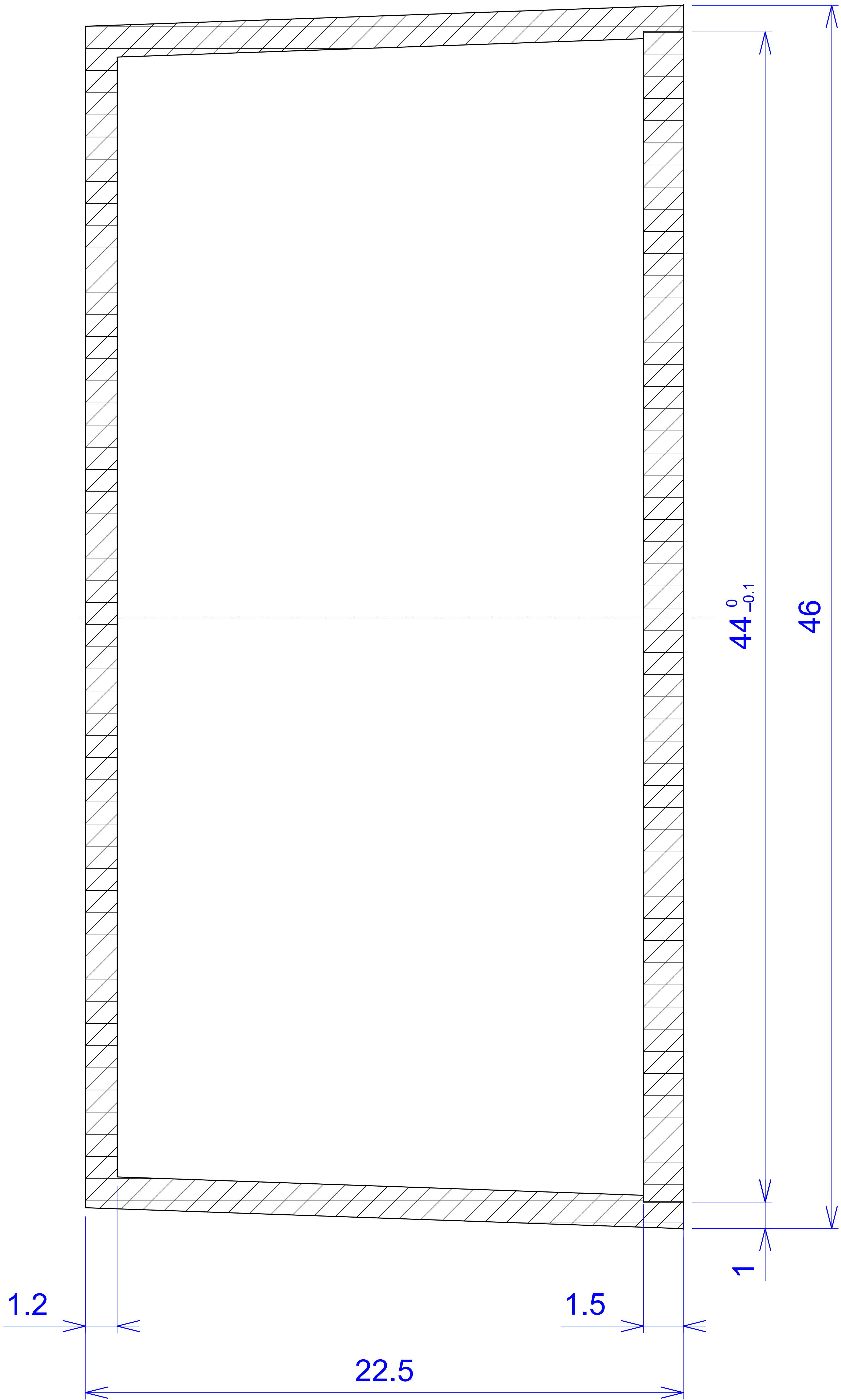



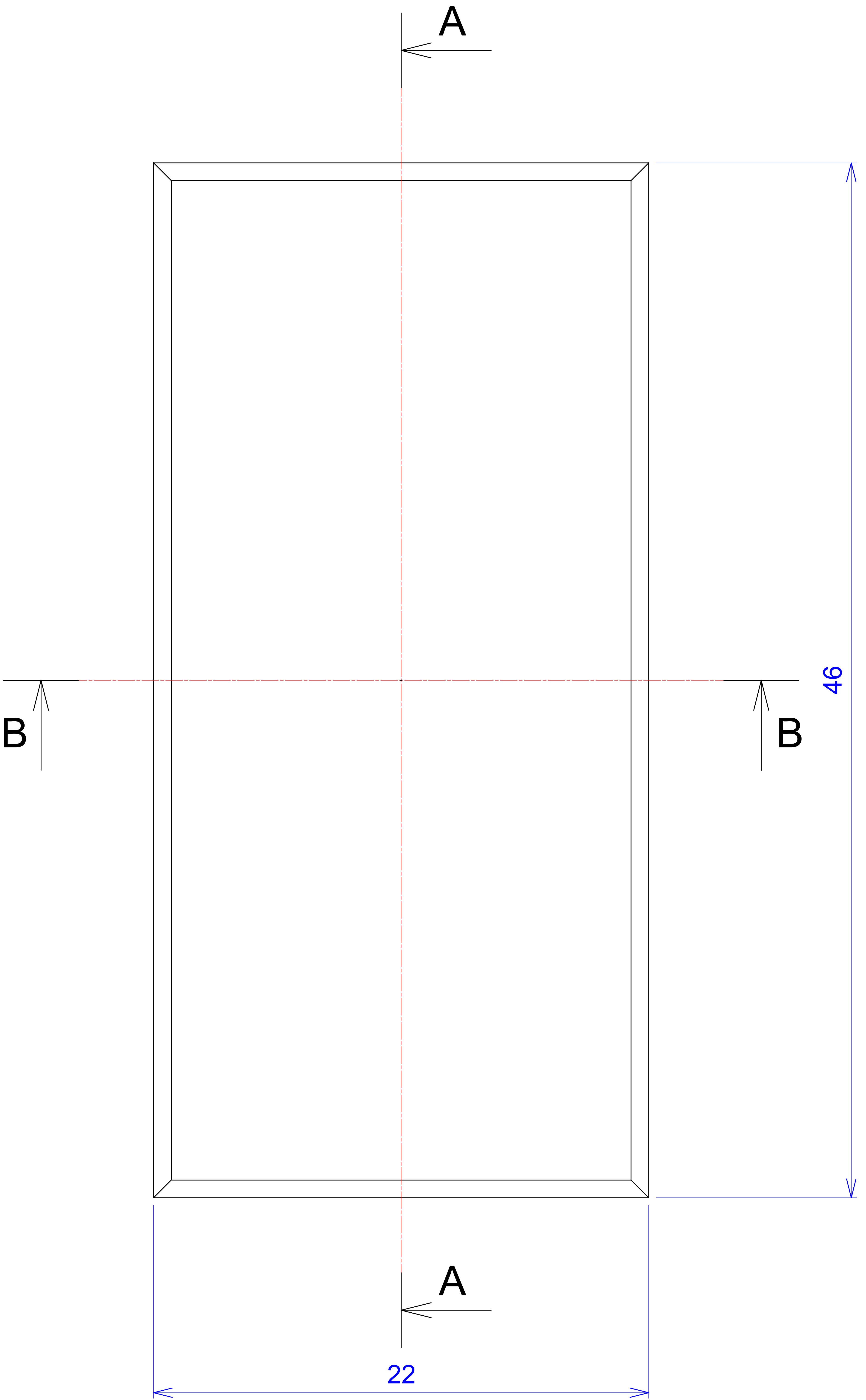

# B - B

