

Feature

- 6.3mm standard pin
- Low forward voltage drop
- Isolation voltage 2000V ~
- UL registered E304417

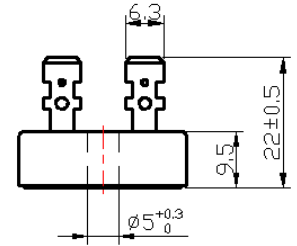
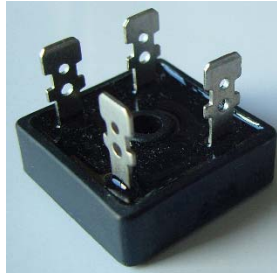

Application

- Power supply for DC power device
- Input rectifier for PWM convertor
- Power supply for DC device

Advantage

- Easy mounting
- Small size, light weight
- Low thermal resistance, high heat-conduction rate, low temperature rise

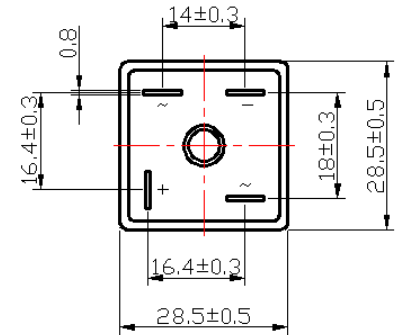
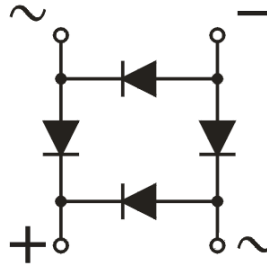

■ Maximum value

Symbol	Parameter	Rating	Unit
		BR3510	
V_{RRM}	Peak reverse repetitive voltage	1000	V
V_{RSM}	Peak reverse non-repetitive voltage	1100	V

Symbol	Parameter	Test condition	Rating	Unit
$I_{F(AV)}$	Forward average current	180° sine half-wave 50HZ single-sided heat dissipation $T_c=80^\circ\text{C}$	35	A
I_{FSM}	Forward surge current	$t=10\text{ms}, 50\text{HZ}, \text{sin}, T_{jm}$	400	A
I^2t	I^2t value		660	A^2S
V_{ISO}	Isolation voltage	AC one minute	2000	V
T_j	Operating junction temperature		-40 to +150	$^\circ\text{C}$
T_{jm}	Rated junction temperature		150	$^\circ\text{C}$
T_{stg}	Storage temperature		-40 to +125	$^\circ\text{C}$
M_d	Mounting torque M5		2	N·m
W_t	Weight		18	g

■ Electrical characteristics

Symbol	Parameter	Test condition	Rating	Unit
I_{RRM}	Peak reverse repetitive current	$V_R=V_{RRM}$, sine half-wave, $T_j=25^\circ\text{C}$	5	μA
		$V_R=V_{RRM}$, sine half-wave, $T_j=150^\circ\text{C}$	3	mA
V_{FM}	Peak forward voltage	$I_{FM}=52.5\text{A}$, $T_j=25^\circ\text{C}$	1.3	V
$R_{th(j-c)}$	Thermal impedance (junction-case)	Single-sided heat dissipation, sine half-wave	1.4	$^\circ\text{C/W}$