

## BC817-16-G/25-G/40-G (NPN) RoHS Device

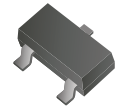

### Features

- For general AF applications.
- High collector current.
- High current gain.
- Low collector-emitter saturation voltage.

### Marking:

BC817-16-G: 6A  
BC817-25-G: 6B  
BC817-40-G: 6C

### Diagram:

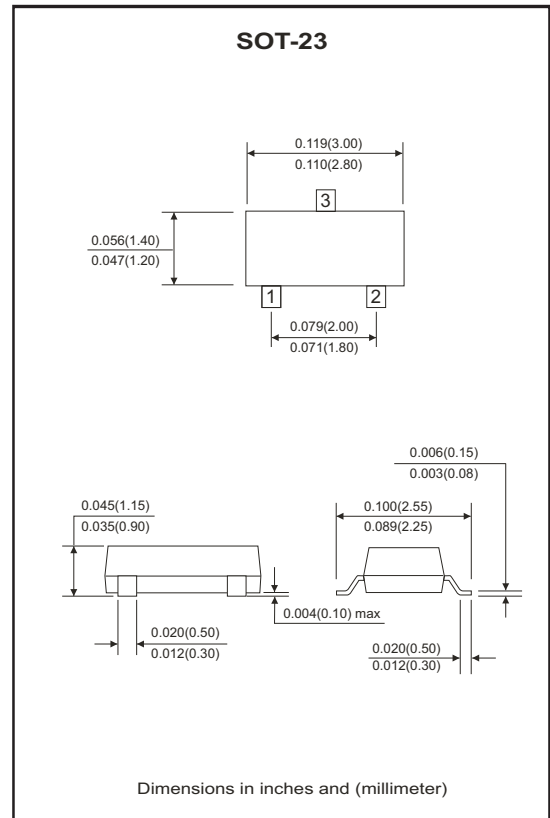
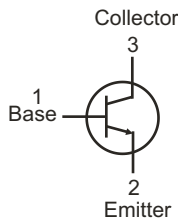

### Maximum Ratings (at TA=25°C unless otherwise noted)

| Parameter                              | Symbol         | Value       | Unit |
|--|----------------|-------------|------|
| Collector-Base voltage                 | $V_{CBO}$      | 50          | V    |
| Collector-Emitter voltage              | $V_{CEO}$      | 45          | V    |
| Emitter-Base voltage                   | $V_{EBO}$      | 5           | V    |
| Collector current-continuous           | $I_C$          | 500         | mA   |
| Collector power dissipation            | $P_C$          | 300         | mW   |
| Junction and storage temperature range | $T_J, T_{STG}$ | -55 to +150 | °C   |

## Electrical Characteristics (at $T_A=25^\circ\text{C}$ unless otherwise noted)

| Parameter                            | Symbol        | Conditions   | Min | Typ | Max | Unit          |
|--------------------------------------|---------------|--|-----|-----|-----|---------------|
| Collector-Base breakdown voltage     | $V_{(BR)CBO}$ | $I_C = 10\mu\text{A}, I_E = 0$                             | 50  |     |     | V             |
| Collector-Emitter breakdown voltage  | $V_{(BR)CEO}$ | $I_C = 10\text{mA}, I_B = 0$                               | 45  |     |     | V             |
| Emitter-Base breakdown voltage       | $V_{(BR)EBO}$ | $I_E = 1\mu\text{A}, I_C = 0$                              | 5   |     |     | V             |
| Collector cut-off current            | $I_{CBO}$     | $V_{CB} = 45\text{V}, I_E = 0$                             |     |     | 0.1 | $\mu\text{A}$ |
| Emitter cut-off current              | $I_{EBO}$     | $V_{EB} = 4\text{V}, I_C = 0$                              |     |     | 0.1 | $\mu\text{A}$ |
| DC current gain                      | $h_{FE(1)}$   | $V_{CE} = 1\text{V}, I_C = 100\text{mA}$                   | 100 |     | 600 |               |
|                                      | $h_{FE(2)}$   | $V_{CE} = 1\text{V}, I_C = 500\text{mA}$                   | 40  |     |     |               |
| Collector-Emitter saturation voltage | $V_{CE(SAT)}$ | $I_C = 500\text{mA}, I_B = 50\text{mA}$                    |     |     | 0.7 | V             |
| Base-Emitter saturation voltage      | $V_{BE(SAT)}$ | $I_C = 500\text{mA}, I_B = 50\text{mA}$                    |     |     | 1.2 | V             |
| Base-Emitter voltage                 | $V_{BE(ON)}$  | $V_{CE} = 1\text{V}, I_C = 500\text{mA}$                   |     |     | 1.2 | V             |
| Collector capacitance                | $C_{ob}$      | $V_{CB} = 10\text{V}, f = 100\text{MHz}$                   |     | 10  |     | pF            |
| Transition frequency                 | $f_T$         | $V_{CE} = 5\text{V}, I_C = 10\text{mA}, f = 100\text{MHz}$ | 100 |     |     | MHz           |

## Classification of $h_{FE(1)}$

| Rank  | BC817-16-G | BC817-25-G | BC817-40-G |
|-------|------------|------------|------------|
| Range | 100-250    | 160-400    | 250-600    |

## RATING AND CHARACTERISTIC CURVES (BC817-16-G/25-G/40-G)

Fig.1 - Static Characteristic

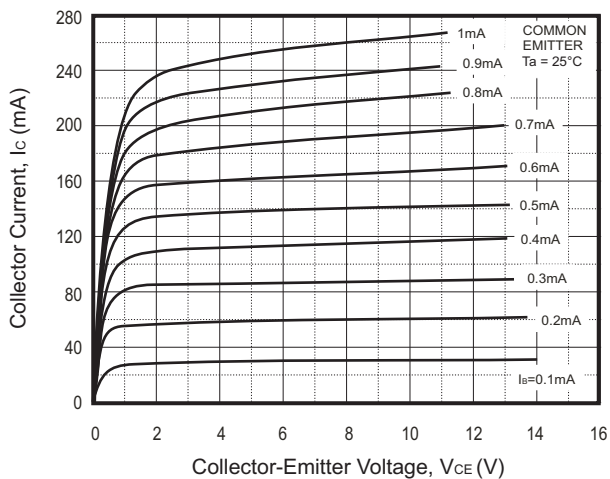
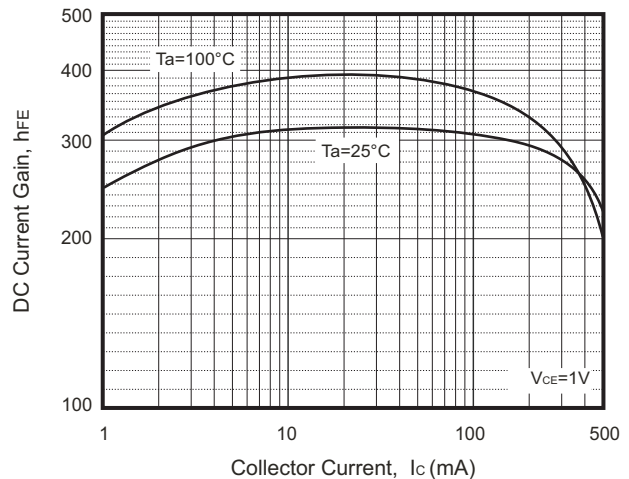

Fig.2 -  $h_{FE} - I_C$



## RATING AND CHARACTERISTIC CURVES (BC817-16-G/25-G/40-G)

Fig.3 -  $V_{BEsat} - I_C$

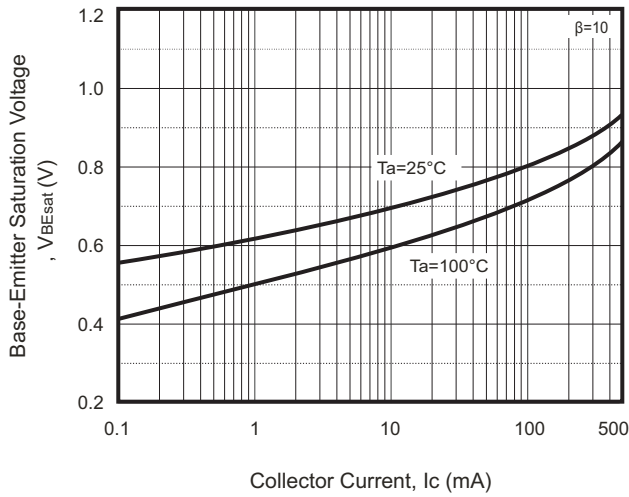

Fig.4 -  $V_{CEsat} - I_C$

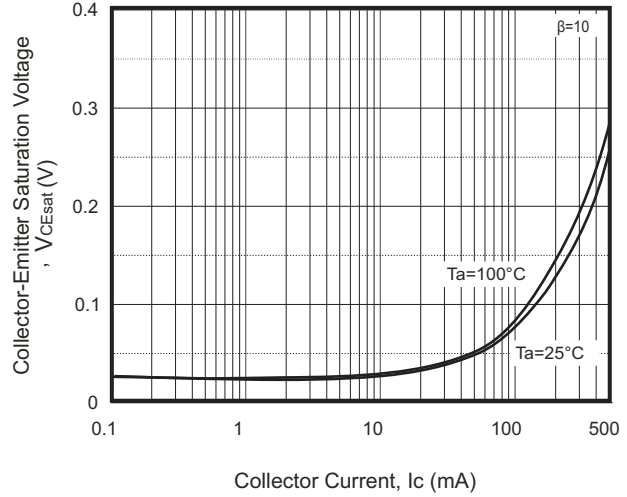

Fig.5 -  $I_C - V_{BE}$

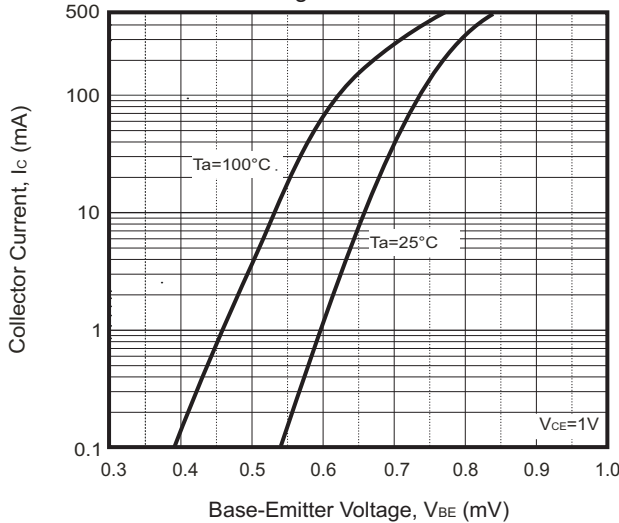

Fig.6 -  $C_{ob}/C_{ib} - V_{CB}/V_{EB}$

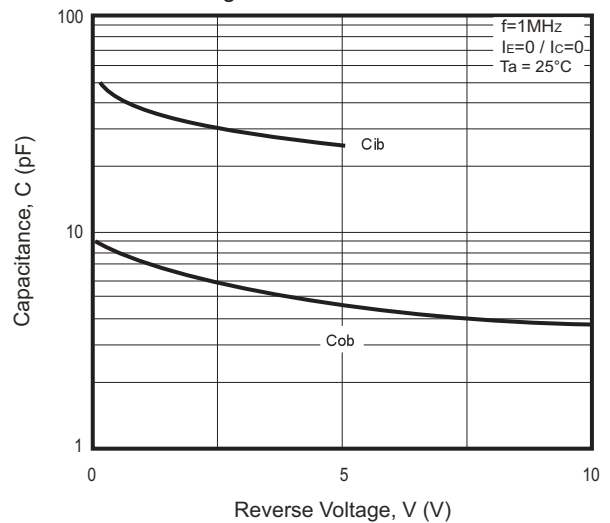

Fig.7 -  $f_T - I_C$

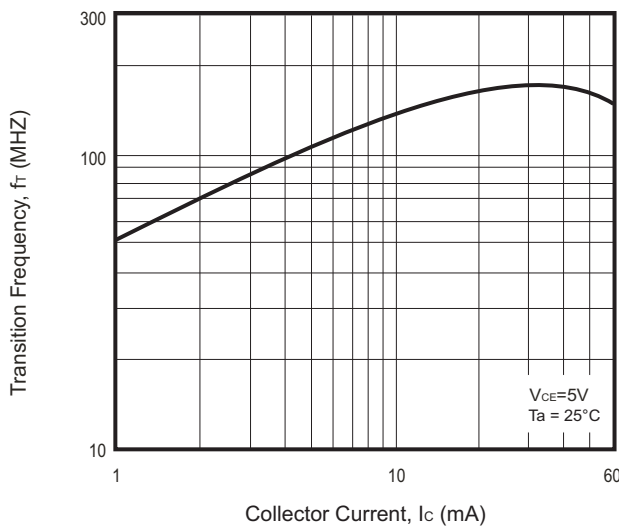
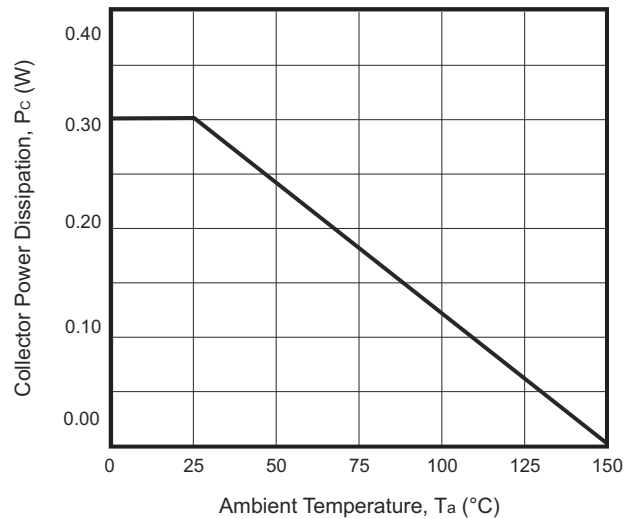
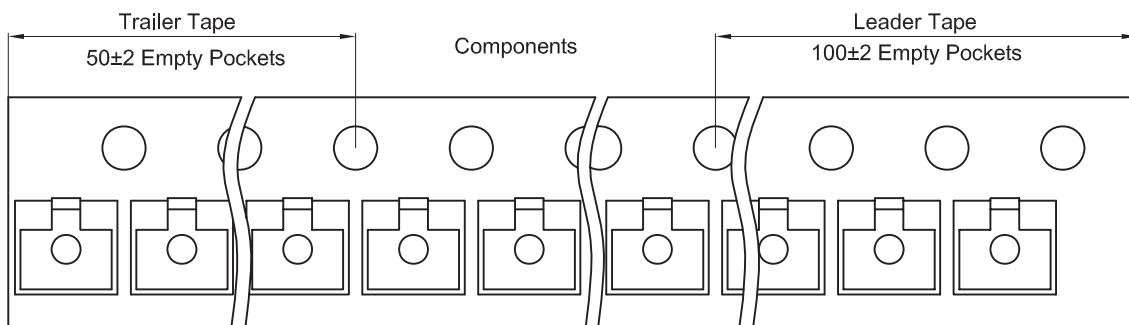
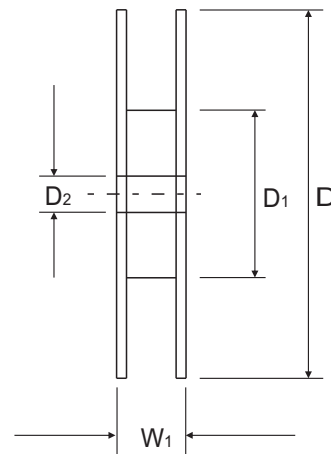
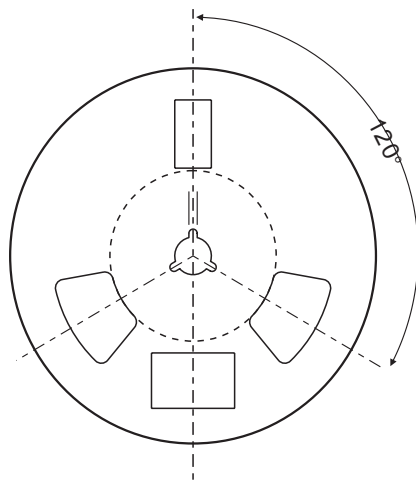
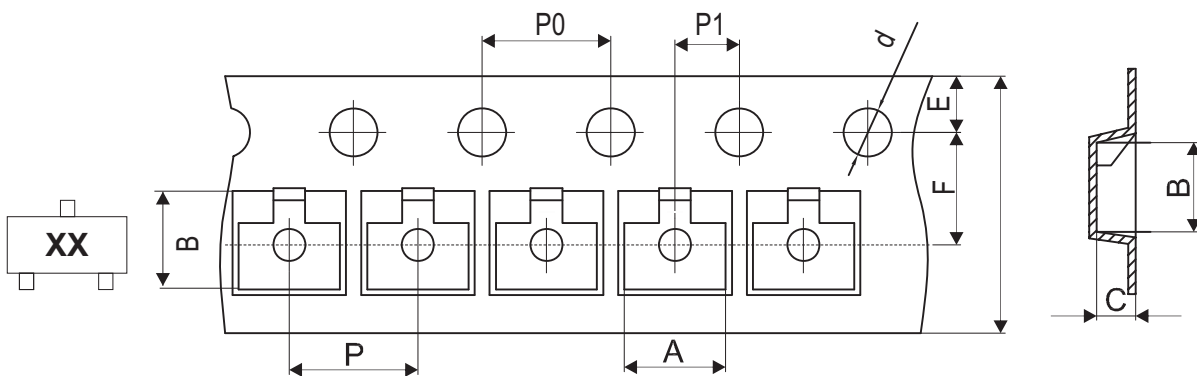

Fig.8 -  $P_c - T_a$



## Reel Taping Specification



| SOT-23 | SYMBOL | A             | B             | C             | d             | D             | D1            | D2            |
|--------|--------|---------------|---------------|---------------|---------------|---------------|---------------|---------------|
|        | (mm)   | 3.15 ± 0.10   | 2.77 ± 0.10   | 1.22 ± 0.10   | 1.50 ± 0.10   | 178.00 ± 2.00 | 54.40 ± 1.00  | 13.00 ± 1.00  |
|        | (inch) | 0.124 ± 0.004 | 0.109 ± 0.004 | 0.048 ± 0.004 | 0.059 ± 0.004 | 7.008 ± 0.079 | 2.142 ± 0.039 | 0.512 ± 0.039 |

| SOT-23 | SYMBOL | E             | F             | P             | P0            | P1            | W                       | W1            |
|--------|--------|---------------|---------------|---------------|---------------|---------------|-------------------------|---------------|
|        | (mm)   | 1.75 ± 0.10   | 3.50 ± 0.10   | 4.00 ± 0.10   | 4.00 ± 0.10   | 2.00 ± 0.10   | 8.00 + 0.30 / - 0.10    | 12.30 ± 1.00  |
|        | (inch) | 0.069 ± 0.004 | 0.138 ± 0.004 | 0.157 ± 0.004 | 0.157 ± 0.004 | 0.079 ± 0.004 | 0.315 + 0.012 / - 0.004 | 0.484 ± 0.039 |

Company reserves the right to improve product design , functions and reliability without notice.

## Marking Code

| Part Number | Marking Code |
|-------------|--------------|
| BC817-16-G  | 6A           |
| BC817-25-G  | 6B           |
| BC817-40-G  | 6C           |

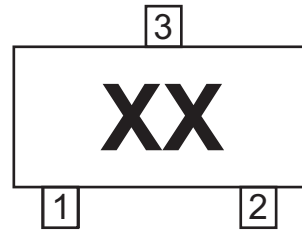

xx = Product type marking code

## Suggested PAD Layout

| SIZE | SOT-23 |        |
|------|--------|--------|
|      | (mm)   | (inch) |
| A    | 0.80   | 0.031  |
| B    | 0.60   | 0.024  |
| C    | 1.90   | 0.075  |
| D    | 2.02   | 0.080  |
| E    | 2.82   | 0.111  |

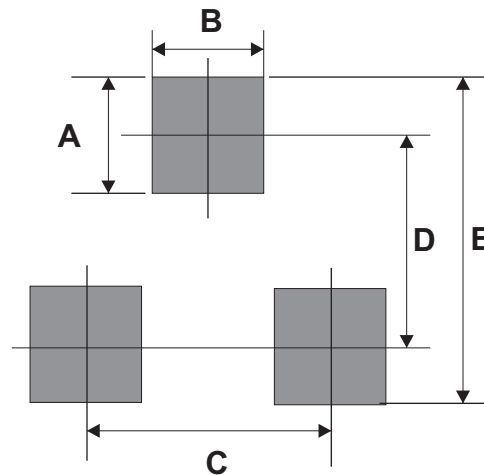

## Standard Packaging

| Case Type | Qty Per Reel | Reel Size |
|-----------|--------------|-----------|
|           | (Pcs)        | (inch)    |
| SOT-23    | 3,000        | 7         |

# Mouser Electronics

Authorized Distributor

Click to View Pricing, Inventory, Delivery & Lifecycle Information:

[Comchip Technology:](#)

[BC817-25-G](#)