

## Female Header Series

KLS1-208C Female Header 1.27mm(0.050 ")

### Electrical Characteristics:

- Current Rating: 1 AMP
- Insulator Resistance: 5000MΩmin. at DC 500V
- Contact Resistance: 20mΩmax. at DC 100mA
- Operating Temperature: -45°C~+105°C

### Material:

- Housing: 30% Glass filled PBT UL94V-0
- Contacts: Brass
- Plating: Gold plated: 0.8u" over 50u" nickel

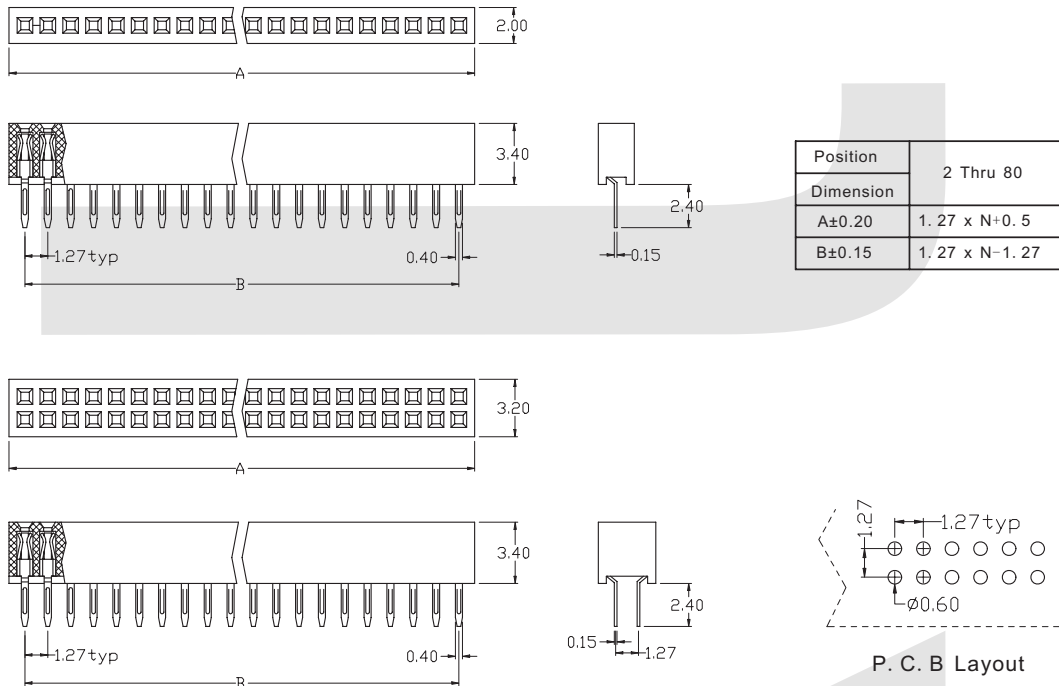
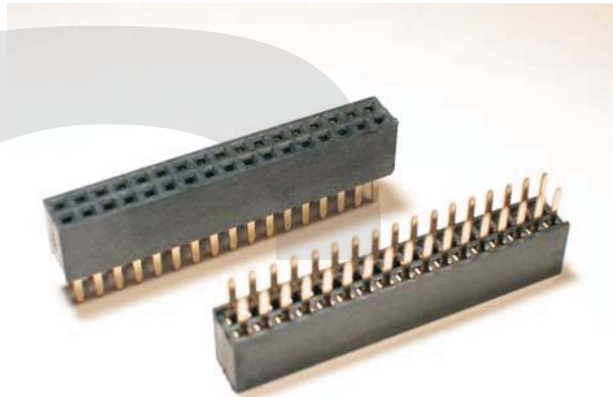

## ORDER INFORMATION

Product No.: KLS1-208C-3.4-1-XX-S

Pos. No. \_\_\_\_\_  
Female Header 1.27mm Series  
Height: 4.4mm, 3.4mm

Tail Style: S=Straight Pin R=Right Pin T=SMT Pin  
Total pin number: XX=06-64Pin  
1=Single layer 2=Double layer



**Female Header Series**

KLS1-208C Female Header 1.27mm(0.050 ")

**Electrical Characteristics:**

- Current Rating: 1 AMP
- Insulator Resistance: 5000MΩmin. at DC 500V
- Contact Resistance: 20mΩmax. at DC 100mA
- Operating Temperature: -45°C~+105°C

**Material:**

- Housing: 30% Glass filled PBT UL94V-0
- Contacts: Brass
- Plating: Gold plated: 0.8u" over 50u" nickel

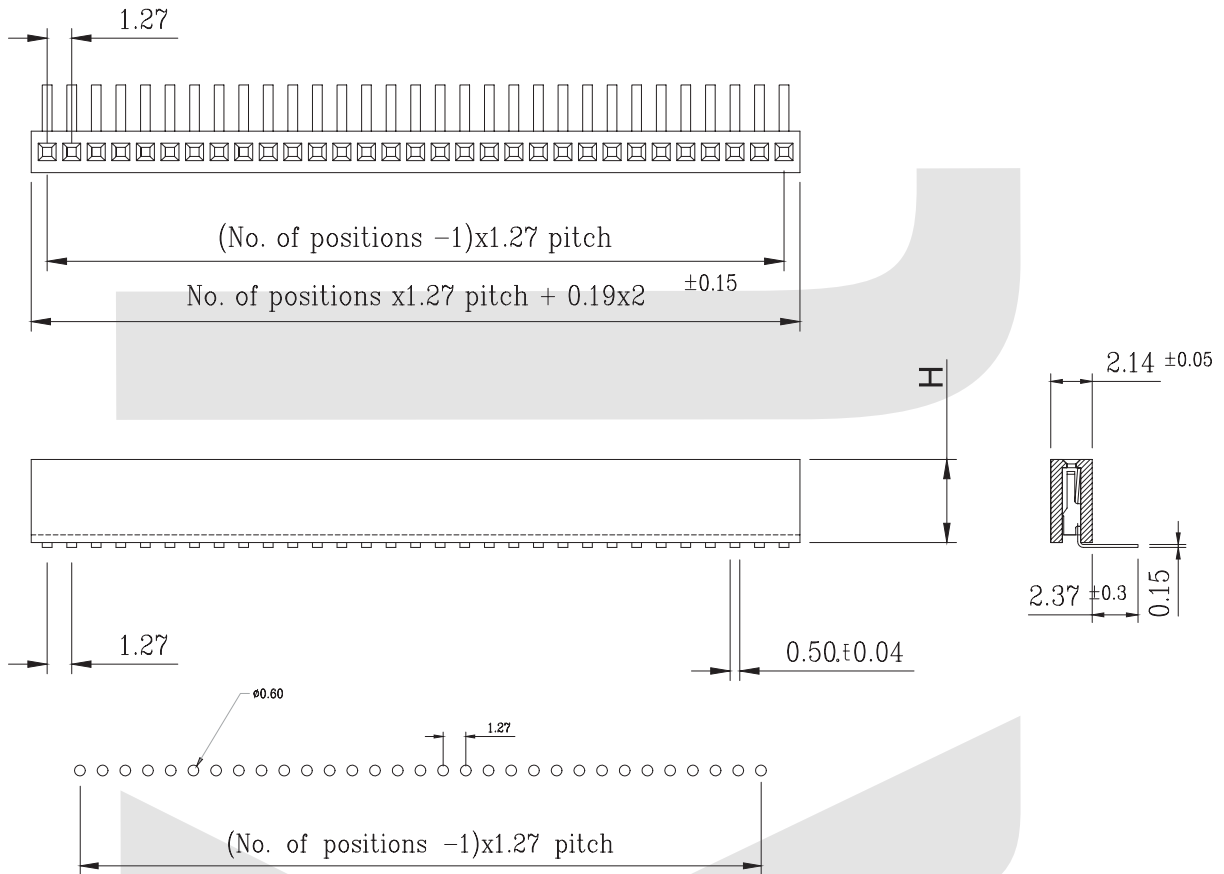
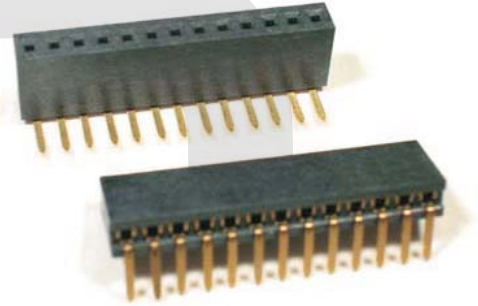

**ORDER INFORMATION**

Product No.: KLS1-208C-3.4-1-XX-R

Pos. No. \_\_\_\_\_  
Female Header 1.27mm Series  
Height: 4.4mm, 3.4mm

Tail Style: S=Straight Pin R=Right Pin T=SMT Pin  
Total pin number: XX=06-64Pin  
1=Single layer 2=Double layer



**Female Header Series**

KLS1-208C Female Header 1.27mm(0.050 ")

**Electrical Characteristics:**

- Current Rating: 1 AMP
- Insulator Resistance: 5000MΩmin. at DC 500V
- Contact Resistance: 20mΩmax. at DC 100mA
- Operating Temperature: -45°C~+105°C

**Material:**

- Housing: 30% Glass filled PBT UL94V-0
- Contacts: Brass
- Plating: Gold plated: 0.8u" over 50u" nickel

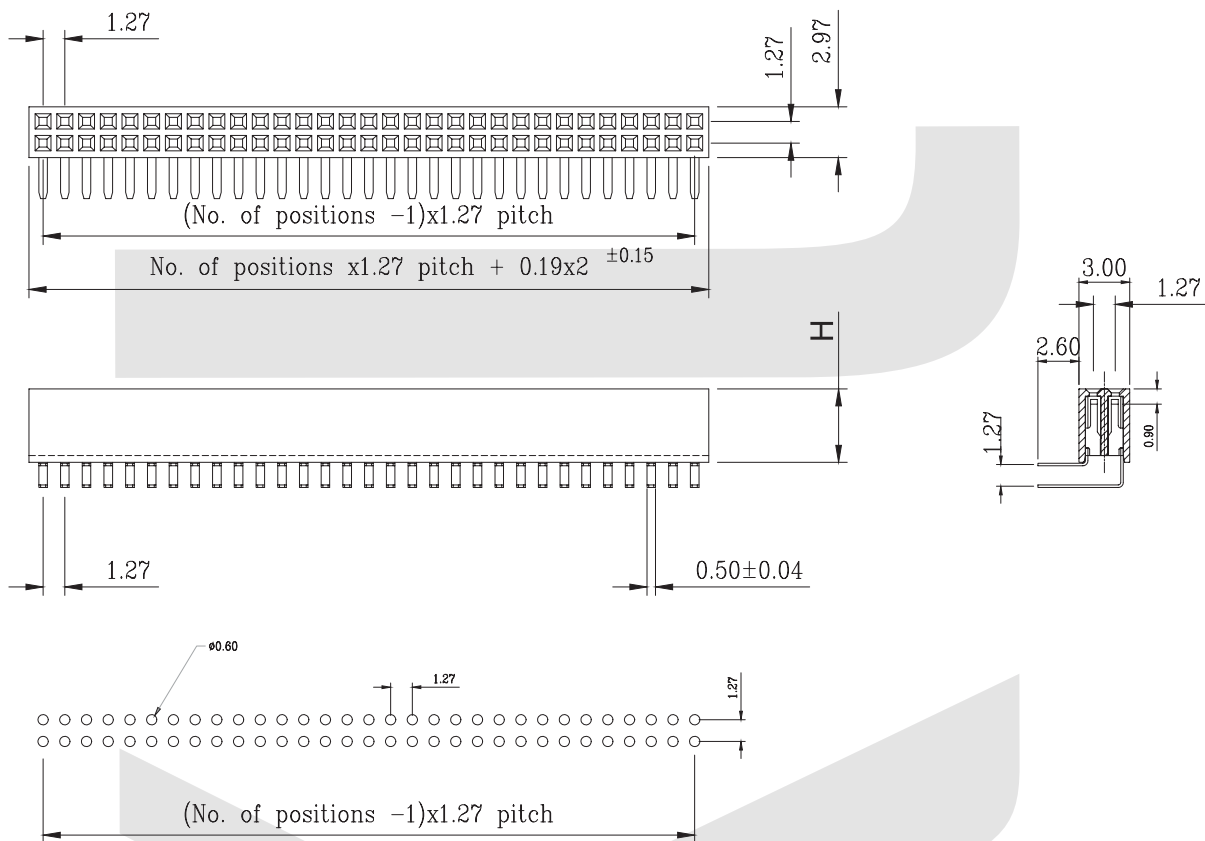
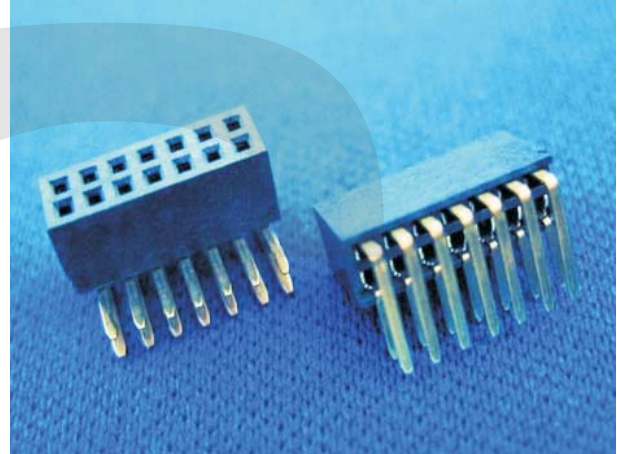

**ORDER INFORMATION**

Product No.: KLS1-208C-3.4-1-XX-R

Pos. No. \_\_\_\_\_  
Female Header 1.27mm Series  
Height: 4.4mm, 3.4mm

Tail Style: S=Straight Pin R=Right Pin T=SMT Pin  
Total pin number: XX=06-64Pin  
1=Single layer 2=Double layer



**Female Header Series**

KLS1-208C Female Header 1.27mm(0.050 ")

**Electrical Characteristics:**

- Current Rating: 1 AMP
- Insulator Resistance: 5000MΩmin. at DC 500V
- Contact Resistance: 20mΩmax. at DC 100mA
- Operating Temperature: -45°C~+105°C

**Material:**

- Housing: 30% Glass filled PBT UL94V-0
- Contacts: Brass
- Plating: Gold plated: 0.8u" over 50u" nickel

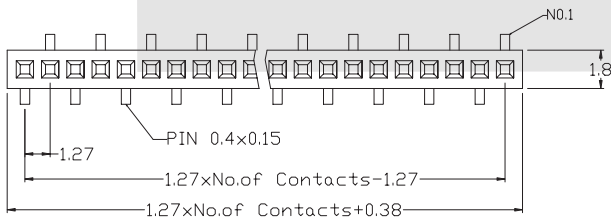
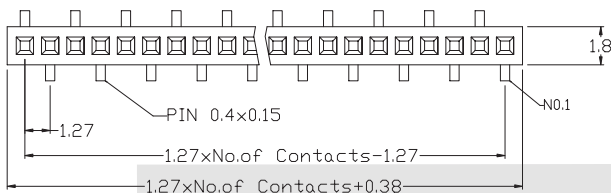
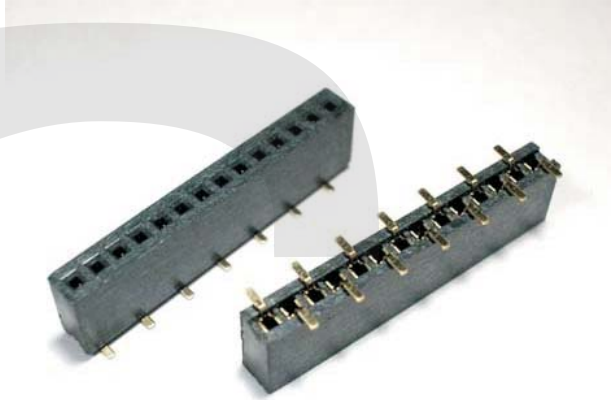

T1 Type

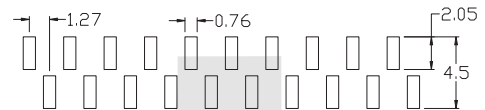

T2 Type



PCB Layout

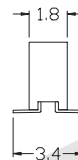

**ORDER INFORMATION**

Product No.: KLS1-208C-3.4-1-XX-T4

Pos. No. \_\_\_\_\_  
 Female Header 1.27mm Series  
 Height: 4.4mm, 3.4mm, 2.1mm

Tail Style: S=Straight Pin R=Right Pin T=SMT Pin  
 Total pin number: XX=06-64Pin  
 1=Single layer

## Female Header Series

KLS1-208C Female Header 1.27mm(0.050 ")

### Electrical Characteristics:

- Current Rating: 1 AMP
- Insulator Resistance: 5000MΩmin. at DC 500V
- Contact Resistance: 20mΩmax. at DC 100mA
- Operating Temperature: -45°C~+105°C

### Material:

- Housing: 30% Glass filled PBT UL94V-0
- Contacts: Brass
- Plating: Gold plated: 0.8u" over 50u" nickel

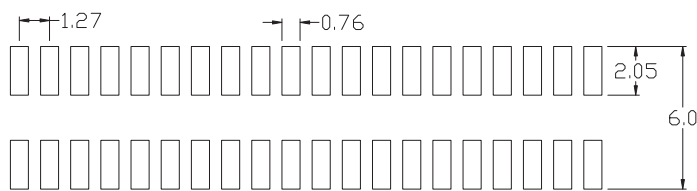
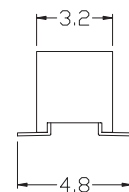
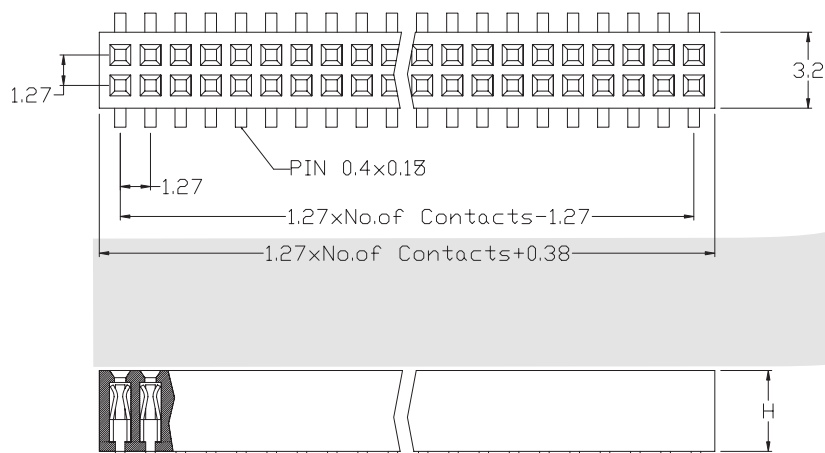
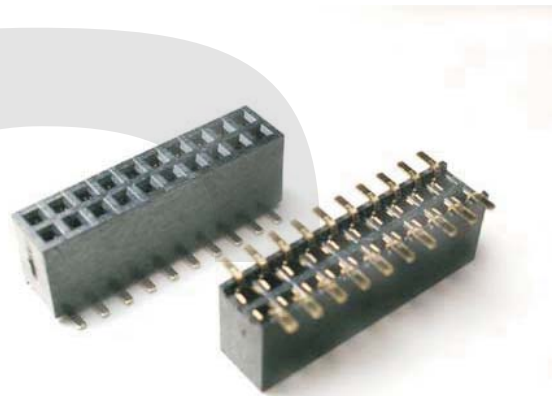

PCB Layout

## ORDER INFORMATION

Product No.: KLS1-208C-3.4-2-XX-T

Pos. No. \_\_\_\_\_  
Female Header 1.27mm Series  
Height: 4.4mm, 3.4mm

Tail Style: S=Straight Pin R=Right Pin T=SMT Pin  
Total pin number: XX=06-64Pin  
2=Double layer

## Female Header Series

KLS1-208C Female Header 1.27mm(0.050 ")With positioning

### Electrical Characteristics:

- Current Rating: 1 AMP
- Insulator Resistance: 5000MΩmin. at DC 500V
- Contact Resistance: 20mΩmax. at DC 100mA
- Operating Temperature: -45°C~+105°C

### Material:

- Housing: 30% Glass filled PBT UL94V-0
- Contacts: Brass
- Plating: Gold plated: 0.8u" over 50u" nickel

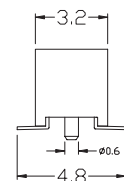
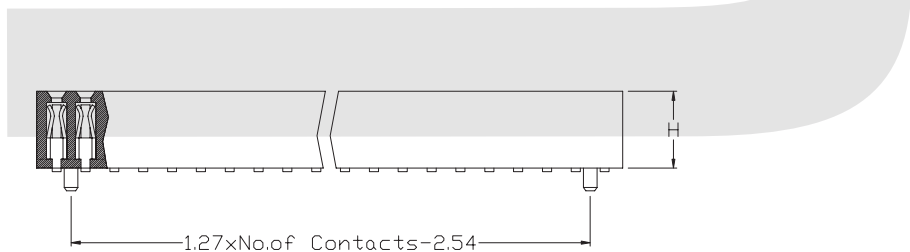
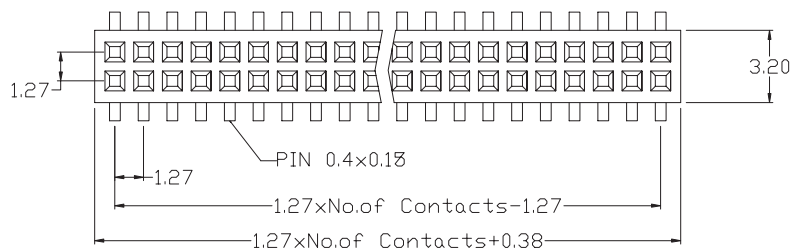
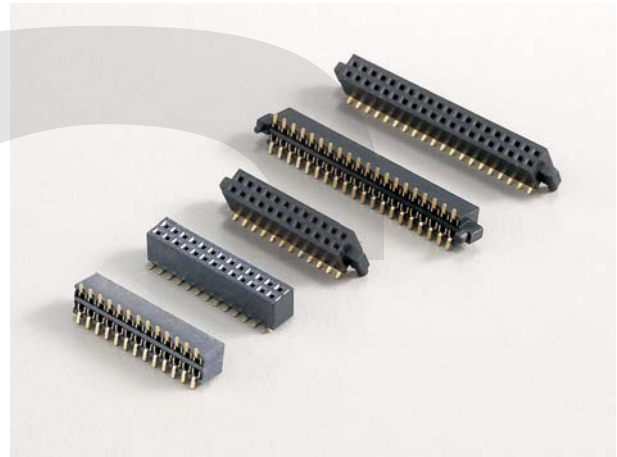

T3 Type

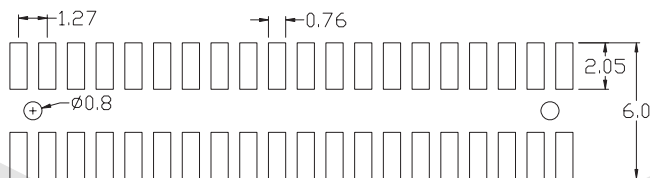

PCB Layout

## ORDER INFORMATION

Product No.: **KLS1-208C-4.3-1-XX-T3**

Pos. No. \_\_\_\_\_  
Female Header 1.27mm Series  
Height: 3.4mm, 4.3mm

Tail Style: S=Straight Pin R=Right Pin T=SMT Pin  
Total pin number: XX=06-64Pin  
1=Single layer 2=Double layer

## Female Header Series

KLS1-208C Female Header 1.27mm(0.050 ")With positioning

### Electrical Characteristics:

- Current Rating: 1 AMP
- Insulator Resistance: 5000MΩmin. at DC 500V
- Contact Resistance: 20mΩmax. at DC 100mA
- Operating Temperature: -45°C~+105°C

### Material:

- Housing: 30% Glass filled PBT UL94V-0
- Contacts: Brass
- Plating: Gold plated: 0.8u" over 50u" nickel

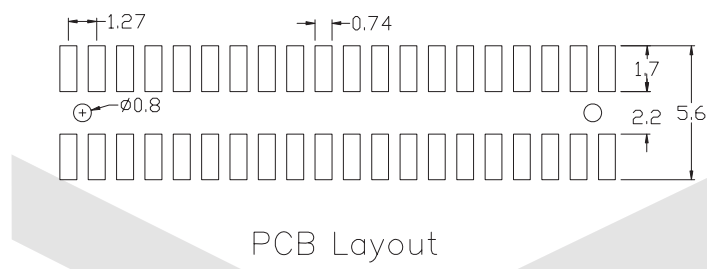
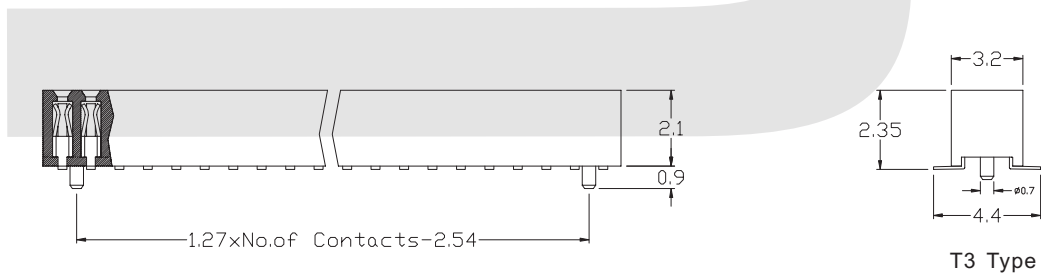
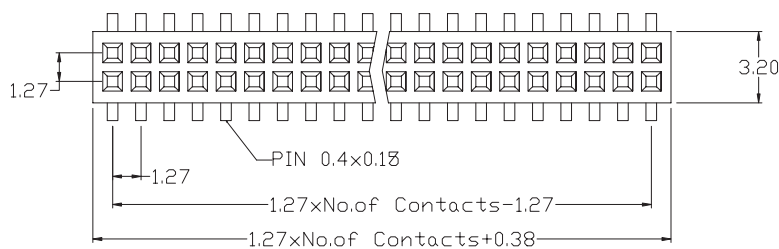
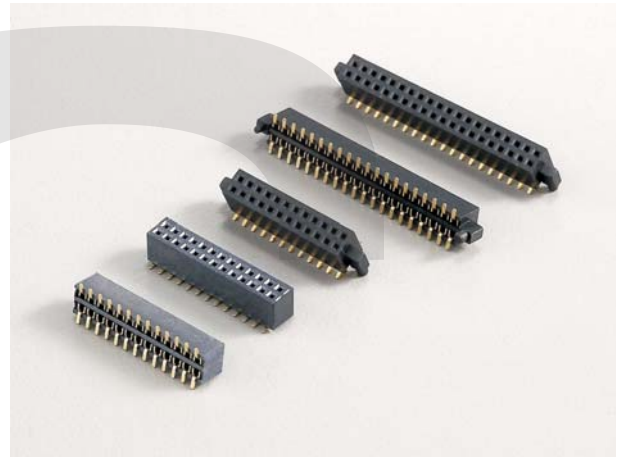

## ORDER INFORMATION

Product No.: KLS1-208C-2.1-1-XX-T3

Pos. No. \_\_\_\_\_  
Female Header 1.27mm Series  
Height: 2.1mm

Tail Style: S=Straight Pin R=Right Pin T=SMT Pin  
Total pin number: XX=06-64Pin  
1=Single layer 2=Double layer



## Female Header Series

KLS1-208C Female Header 1.27mm(0.050 ")With positioning

### Electrical Characteristics:

- Current Rating: 1 AMP
- Insulator Resistance: 5000MΩmin. at DC 500V
- Contact Resistance: 20mΩmax. at DC 100mA
- Operating Temperature: -45°C~+105°C

### Material:

- Housing: 30% Glass filled PBT UL94V-0
- Contacts: Brass
- Plating: Gold plated: 0.8u" over 50u" nickel

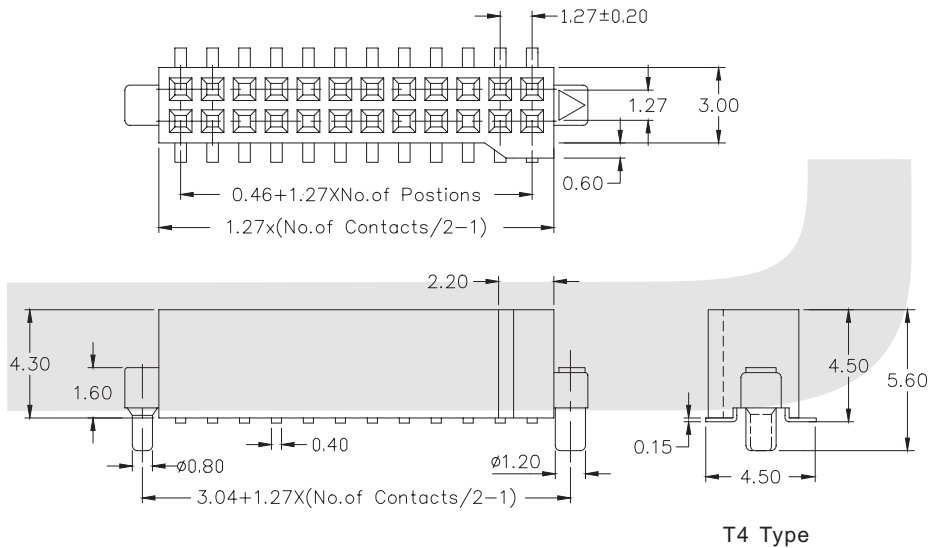
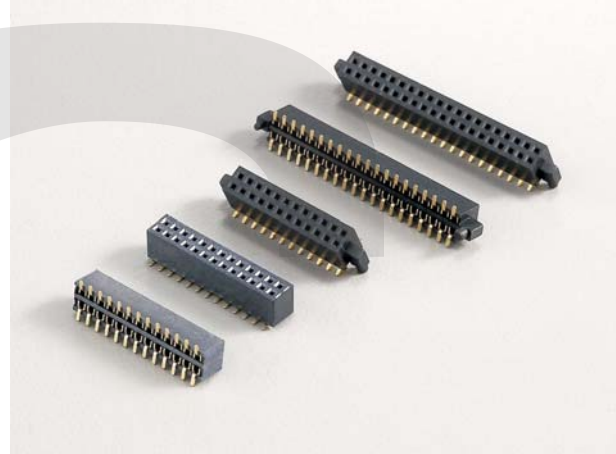

T4 Type

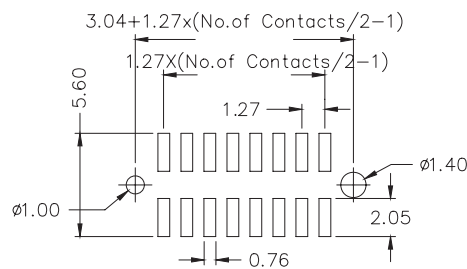

Recommended P.C. Board Layout

## ORDER INFORMATION

Product No.: KLS1-208C-4.3-1-XX-T4

Pos. No. \_\_\_\_\_  
Female Header 1.27mm Series  
Height: 4.3mm

Tail Style: S=Straight Pin R=Right Pin T=SMT Pin  
Total pin number: XX=06-64Pin  
1=Single layer 2=Double layer