

■ Features :

- DC/DC buck-boost converter
- Constant current output: 300mA to 600mA
- Wide input voltage: 9 ~ 36VDC
- Wide output LED string voltage: 2 ~ 40VDC
- High efficiency up to 91%
- Built-in EMI filter, comply with EN55015 and FCC part15 without additional input filter and capacitors
- Built-in PWM and remote ON/OFF control
- Protections: Short circuit / Over temperature
- Cooling by free air convection
- Fully encapsulated with IP67 level
- Compact size
- Low cost, high reliability
- Suitable for driving illumination LED
- 3 years warranty



LDB-350L Blank : pin style
 W : wire style

SPECIFICATION

ORDER NO.		LDB-300L <input type="checkbox"/>	LDB-350L <input type="checkbox"/>	LDB-500L <input type="checkbox"/>	LDB-600L <input type="checkbox"/>	
OUTPUT	CURRENT RANGE	300mA	350mA	500mA	600mA	
	VOLTAGE RANGE	2 ~ 40VDC		2 ~ 32VDC	2 ~ 30VDC	
	CURRENT ACCURACY (Typ.)	±5%				
	RIPPLE & NOISE(max.) Note.2	150mVp-p	150mVp-p	150mVp-p	200mVp-p	
	SWITCHING FREQUENCY	350KHz				
	EXTERNAL CAPACITANCE LOAD (max.)	10uF				
INPUT	VOLTAGE RANGE	9 ~ 36VDC	9 ~ 36VDC	9 ~ 30VDC	9 ~ 28VDC	
	EFFICIENCY (max.)	12VDC	89%	89%	87%	
		24VDC	90%	90%	91%	
	DC CURRENT	Full load	12VDC	1070mA	1120mA	1610mA
			24VDC	530mA	610mA	910mA
No load	5mA					
FILTER	Capacitor					
PWM DIMMING & ON/OFF CONTROL	REMOTE ON/OFF	Leave open if not use Power ON with dimming: DIM ~ -Vin >2 ~ 10VDC or open circuit Power OFF : DIM ~ -Vin < 0.5VDC or short				
	PWM FREQUENCY	100 ~ 1KHz				
	QUIESCENT INPUT CURRENT IN SHUTDOWN MODE(max.)	1mA at PWM dimming OFF and 24VDC input				
PROTECTION	SHORT CIRCUIT	Regulated at rated output current Protection type: Can be continued, recovers automatically after fault condition is removed				
	OVER TEMPERATURE	Tj 145°C typically(IC1) detect on main control IC Protection type : Shut down, recovers automatically after temperature goes down				
ENVIRONMENT	WORKING TEMP.	-40 ~ + 71°C (Refer to derating curve)				
	WORKING HUMIDITY	20% ~ 90% RH non-condensing				
	STORAGE TEMP., HUMIDITY	-55 ~ +125°C, 10 ~ 95% RH				
	TEMP. COEFFICIENT	±0.03% / °C				
	VIBRATION	10 ~ 500Hz, 2G 10min./1 cycle, period for 60min. each along X, Y, Z axes				
OPERATING CASE TEMP. (max.)	110°C					
EMC	EMC EMISSION	Compliance to EN55015, FCC part 15 class B				
	EMC IMMUNITY	Compliance to EN61000-4-2,3,4,6,8, light industry level, criteria A				
OTHERS	MTBF	2000Khrs min. MIL-HDBK-217F (25°C)				
	DIMENSION	31.8*20.3*12.2mm or 1.25**0.8**0.48" inch (L*W*H)				
	WEIGHT	LDB-L:15.6g ; LDB-LW:18g				
	POTTING MATERIAL	Epoxy(UL94-V0)				
NOTE	<p>1.All parameters are specified at normal input(24VDC), rated load, 25°C 70% RH ambient.</p> <p>2.Ripple & noise are measured at 20MHz by using a 12" twisted pair terminated with a 0.1uf capacitor.</p> <p>3.The output of LDB-L should not be connected to the input of the same unit or output from other sources.</p>					

Mechanical Specification

Blank type(LDB – _L):

Unit: mm (inch)

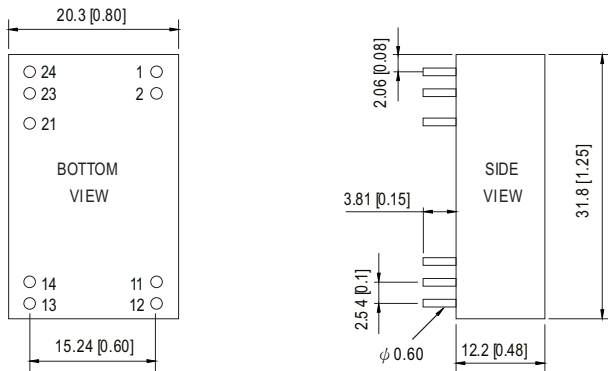

NOTE: Pin tolerance \pm 0.05mm

W type(LDB – _LW):

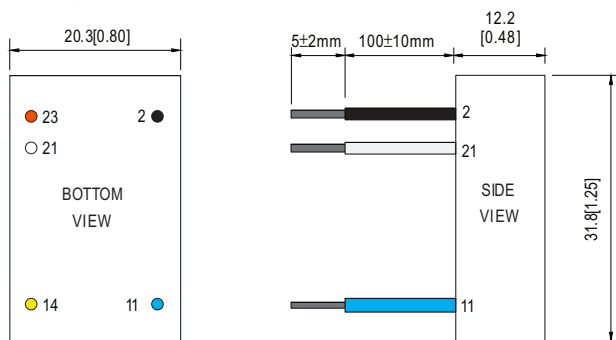

NOTE: All wires UL3385 22AWG

Pin Configuration

Pin No.		Comment
1,2	-Vin	Don't connect to -Vout
11,12	-Vout	LED - Connection
13,14	+Vout	LED + Connection
21	PWM DIM	ON/OFF and PWM Dimming (Leave open if not used)
23,24	+Vin	DC Supply

Pin No.		Comment
2	-Vin (Black)	Don't connect to -Vout
11	-Vout (Blue)	LED - Connection
14	+Vout (Yellow)	LED + Connection
21	PWM DIM (White)	ON/OFF and PWM Dimming (Leave open if not used)
23	+Vin (Red)	DC Supply

Derating Curve

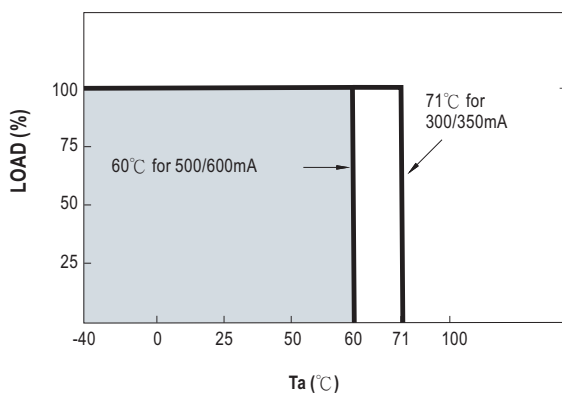

■ PWM Dimming Control

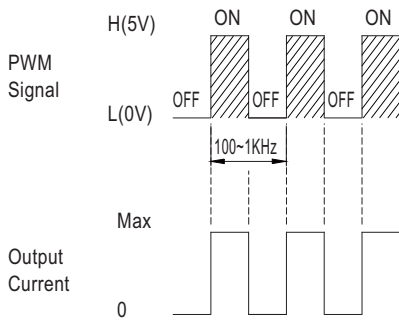

⊙ During PWM dimming operation, the output current will change to PWM style.

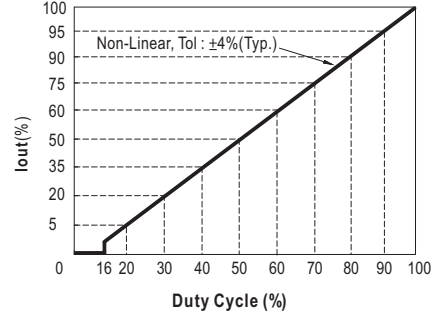

Power OFF : Duty cycle 0 ~ 15%
Power ON : Duty cycle 16 ~ 100%

■ Standard Application

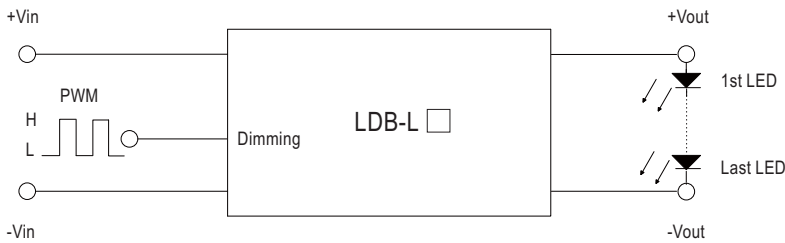

H: >2~10VDC or open circuit
L: <0.5VDC or short

■ Efficiency VS Output Voltage (Number of LEDs)

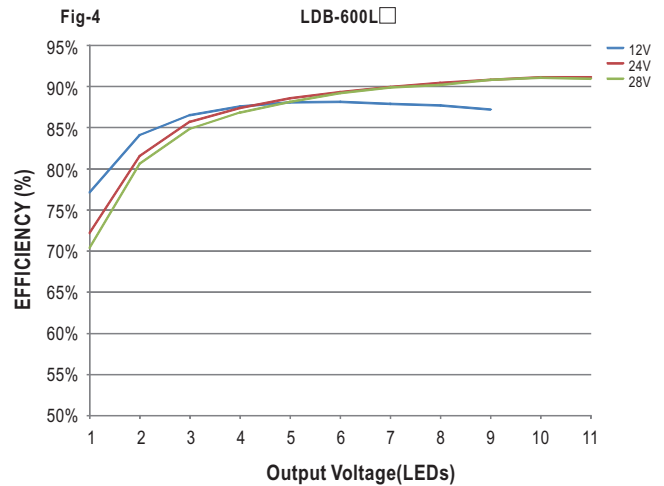
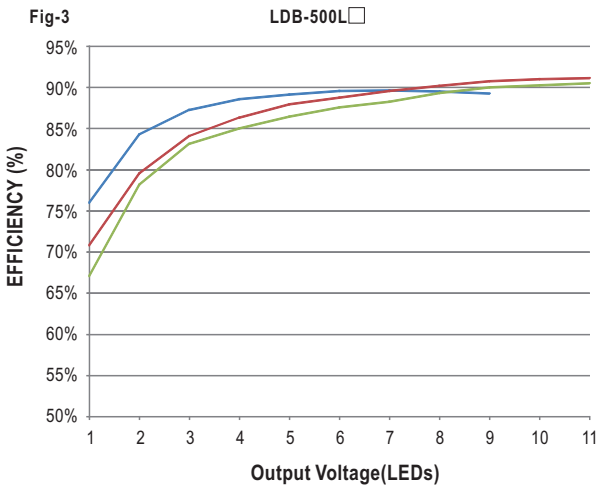
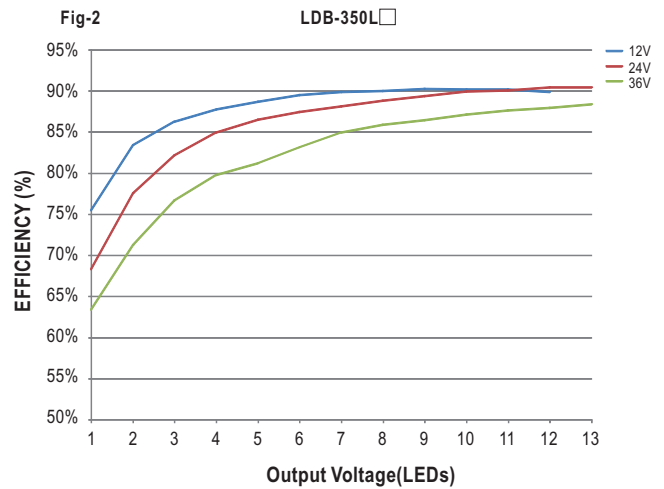
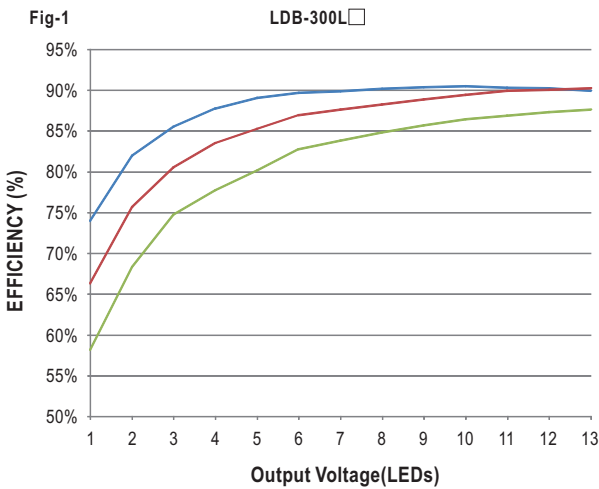

Mouser Electronics

Authorized Distributor

Click to View Pricing, Inventory, Delivery & Lifecycle Information:

[Mean Well:](#)

[LDB-300L](#) [LDB-350L](#) [LDB-500L](#) [LDB-600L](#)