

力英電子股份有限公司 作業指導書

05



客戶：R. C. S(烏克蘭) 料號：LTE-UU105-01

(E03-11102226-01)

項次	日期	更改內容	版次	承辦	核准
1.	91.07.11.	新訂版	A		
2.	96.02.12.	聯絡單業 6-070212,料號由 UU105-01 變更爲 LTE-UU105-01.	A		



分發單位：

單位	資材部	製造部	業務部	工程部	品保部
份數			1		1
簽收					

1. SCHEMATICS.

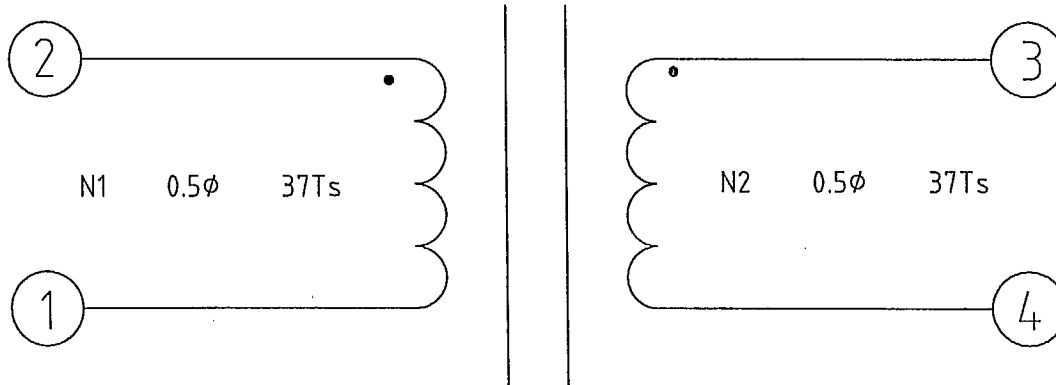

2. WINDING SEQUENCE.

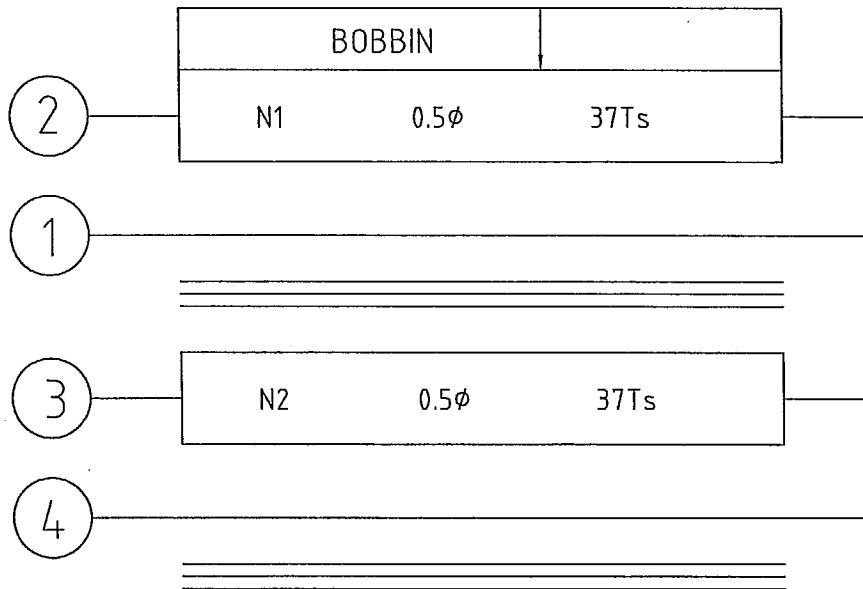

CUSTOMER: 烏克蘭		APPROVED BY:	
PART NO. LTE-UU105-01 (E03-11102226-01)		ISSUE: A	CHECKED BY:
DATE: 2007.02.12.		DRAWN BY:	
		力英電子股份有限公司 LI TONE ELECTRONICS CO., LTD. 台北縣三峽鎮介壽路1段311巷29號 NO. 29, LANE 311, JIE SOU RD., SEC 1. SANHSIA TOWN TAIPEI HSIEN, TAIWAN R. O. C.	
		TEL: (02)2673-2512~6 FAX: 886-2-26710294 886-2-26736329	

3.MATERIAL LIST.

NO/ITEM	MATERIAL	MAKER
1.CORE	UU-10.5 FERRITE CORE. A07.NC-7.	ACME.NICERA.
2.BOBBIN	UU-10.5 V. TYPE W / 4 PINS PHENOLIC / T375J. SW-10.5A.	CHANG CHUN PLASTICS CO.,LTD. UL NO.E59481(S). SWARM BOBBIN INDUSTRIAL CO.,LTD.
3.WIRE	DDNYU / 2UEW / 130°C.	PACIFIC ELECTRIC WIRE & CABLE CO. UL NO.E84081(S).
4.TAPE	POLYESTER TAPE. #1350F-1.	3M COMPANY UL NO.E17385(N).
5.VARNISH	V-1630FS.	P D GEORGE / VIKING . UL NO.E60614(M)
6.CLIP	UU-10.5 HIGH CARBON STEEL.	HEN SHEN INDUSTRIAL CO.,LTD.
7.SOLDER	PURE TIN / Pb<100ppm 2HAO,2LF30	WELLEY SOLDER CO.,LTD.

***ROHS COMPLIANT(無鉛製程)**

4.ELECTRICAL SPECIFICATION.

4-1.INDUCTANCE.(P1-P2) 2.26mH MIN. @1 KHZ 0.25V BY HP-4284A.

4-2.D.C.RESISTANCE.(P1-P2) 0.35Ω MAX. BY GOM-801G.



CUSTOMER: 烏克蘭		APPROVED BY: 
PART NO. LTE-UU105-01 (E03-11102226-01)	ISSUE: A	CHECKED BY: 
DATE: 2007.02.12.		DRAWN BY: 
 		力英電子股份有限公司 LI TONE ELECTRONICS CO., LTD. 台北縣三峽鎮介壽路1段311巷29號 NO. 29, LANE 311, JIE SOU RD., SEC 1. SANHSIA TOWN TAIPEI HSIEN, TAIWAN R. O. C.
		TEL: (02)2673-2512~6 FAX: 886-2-26710294 886-2-26736329

5.CONFIGURATION & DIMENSION.(UNIT:mm)

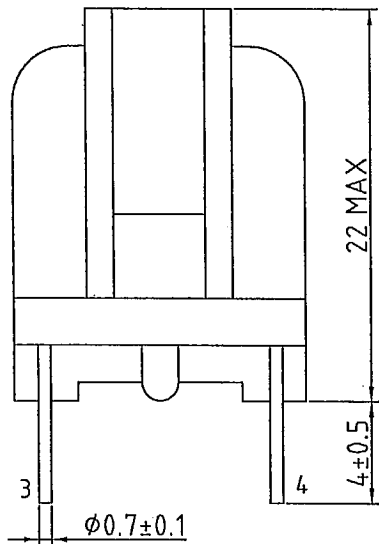

(FRONT VIEW)

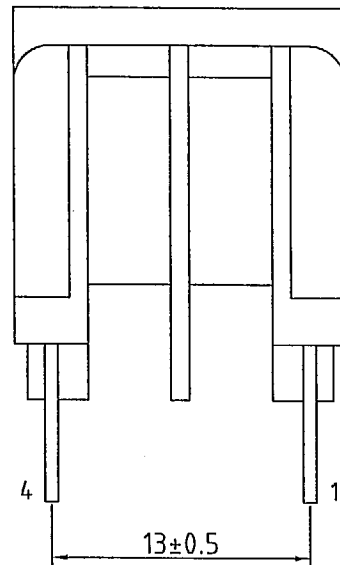

(SIDE VIEW)

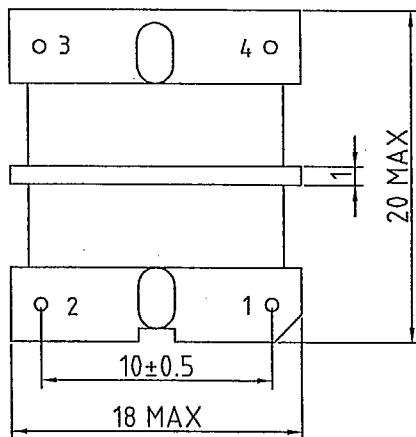

(BOTTOM VIEW)

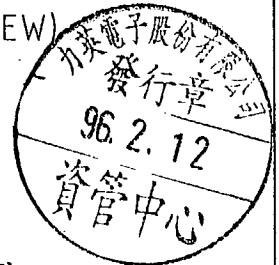

*PIN 1 點白點.

*MARKING: LTE-UU105-01
LTE YYWW

CUSTOMER: 烏克蘭		APPROVED BY:
PART NO. LTE-UU105-01 (E03-11102226-01)	ISSUE: A	CHECKED BY:
DATE: 2007.02.12.		DRAWN BY:
<p>力英電子股份有限公司 LI TONE ELECTRONICS CO., LTD. 台北縣三峽鎮介壽路1段311巷29號 NO. 29, LANE 311, JIE SOU RD., SEC 1. SANHSIA TOWN TAIPEI HSIEN, TAIWAN R. O. C.</p>		TEL: (02)2673-2512~6 FAX: 886-2-26710294 886-2-26736329