

HOLES(4) ARE DESIGNED FOR M2.6X6mm SELF-TAPPING SCREWS USE.
 WALL MOUNTING HOLES(2) X DIA.4.5mm FOR PAN HEAD(M4) TAPPING SCREWS USE.

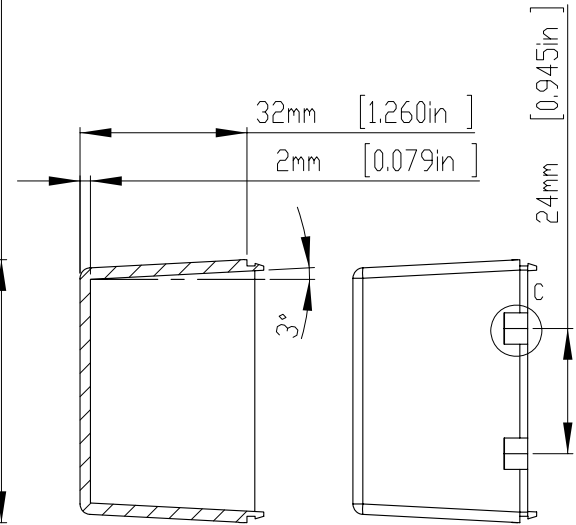

SECTION B-B

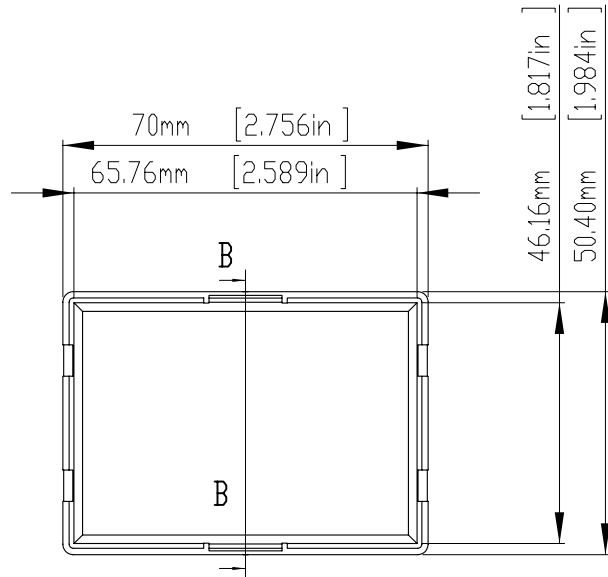
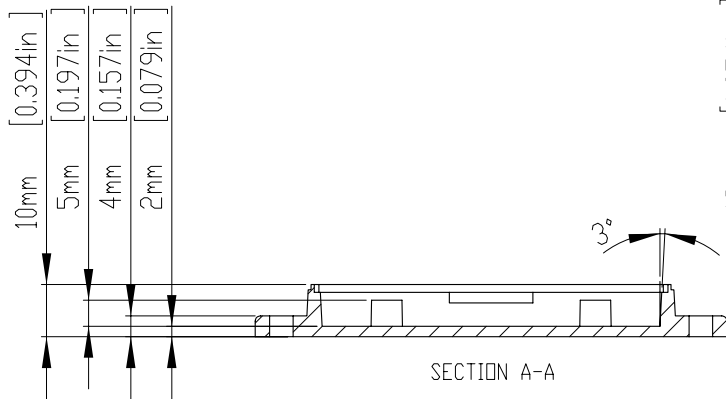

SECTION A-A

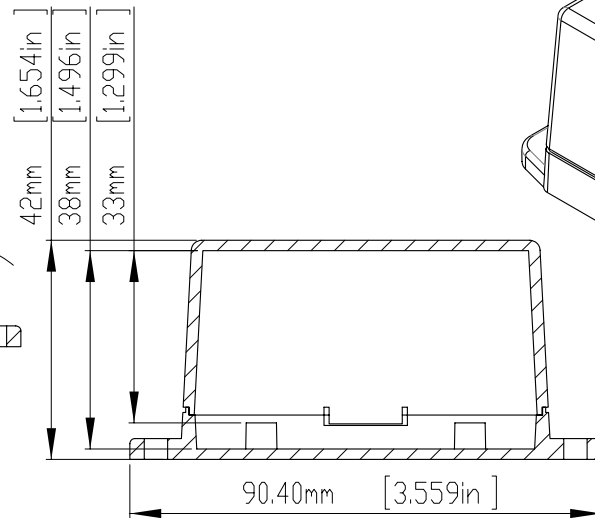

ASSEMBLY

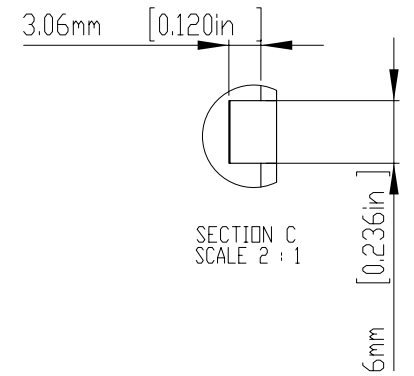
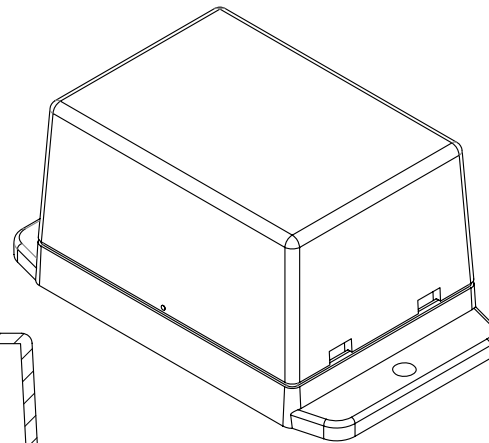

SECTION C
SCALE 2 : 1

According to ISO 2768-m	
Measuring DIM=L	Tolerances
0.5<L≤3.0mm	±0.1mm
3.0<L≤6.0 mm	±0.1mm
6.0<L≤30.0 mm	±0.2mm
30.0<L≤120.0 mm	±0.3mm
120.0<L≤400.0 mm	±0.5mm
400.0<L≤1000.0 mm	±0.8mm

宣又實業有限公司
GAINTA INDUSTRIES LTD.

繪圖 DRA'D BY
JACKY

日期 DATE
2013/10/01

材質 MATE.
ABS

圖名TITLE:
NUB705042

圖號DWG NO:

版次REVISID:
A

ITEM	DESCRIPTION	MATERIAL	COLOR	PANTONE COLOR CORD	CLOSE TO RAL CORD
1	NUB705042BK	ABS<UL94-HB>	BLACK	PANTONE BLACK U	RAL 9005
2	NUB705042WH	ABS<UL94-HB>	WHITE	PANTONE 420C	RAL 9002
3	NUB705042OR	ABS<UL94-HB>	ORANGE	PANTONE 165C	RAL 2004
4	NUB705042RD	ABS<UL94-HB>	RED	PANTONE 186C	RAL 3027

宣又實業有限公司
GAINTA INDUSTRIES LTD.

繪圖 DRA'D BY
JACKY

日期 DATE
2013/10/01

材質 MATE.
ABS

圖名TITLE:
NUB705042

圖號DWG NO:

版次REVISID:
A