



SPECIFICATIONS

CUSTOMER : _____

SAMPLE CODE (Ver.) : _____

MASS PRODUCTION CODE (Ver.) : PC1602LRS-KNH-BY4Q (Ver.0)

DRAWING NO. (Ver.) : DMD-08009 (Ver.0)

Customer Approved

Date: _____

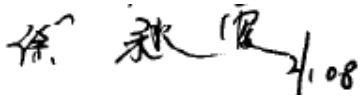
Approved	QC Confirmed	Designer
		

- Approval For Specifications Only.
- * This specification is subject to change without notice.
- Please contact Powertip or it's representative before designing your product based on this specification.
- Approval For Specifications and Sample.

POWERTIP TECH. CORP.

Headquarters:

No.8, 6th Road, Taichung Industrial Park,
 Taichung, Taiwan
 台中市 407 工業區六路 8 號

TEL: 886-4-2355-8168
 FAX: 886-4-2355-8166

E-mail: sales@powertip.com.tw
[Http://www.powertip.com.tw](http://www.powertip.com.tw)

RECORDS OF REVISION

Date	Ver.	Description	Page	Design by
2008/2/1	0	PC1602LRS-KNH-BY4Q is the ROHS compliant part number based on Powertip's standard PC1602LRS-KNH-B-Y4		

Total : 23 Page

Contents

1. SPECIFICATIONS

- 1.1 Features
- 1.2 Mechanical Specifications
- 1.3 Absolute Maximum Ratings
- 1.4 DC Electrical Characteristics
- 1.5 Optical Characteristics
- 1.6 Backlight Characteristics

2. MODULE STRUCTURE

- 2.1 Counter Drawing
- 2.2 Interface Pin Description
- 2.3 Timing Characteristics
- 2.4 Display Command
- 2.5 Character Pattern

3. QUALITY ASSURANCE SYSTEM

- 3.1 Quality Assurance Flow Chart
- 3.2 Inspection Specification

4. RELIABILITY TEST

- 4.1 Reliability Test Condition

5. PRECAUTION RELATING PRODUCT HANDLING

- 5.1 Safety
- 5.2 Handling
- 5.3 Storage
- 5.4 Terms of Warranty

6. PACKING Specification

Note : For detailed information please refer to IC data sheet : [ST7066U,ST7065C](#)

1. SPECIFICATIONS

1.1 Features

Item	Standard Value
Display Type	16*2 Characters
LCD Type	STN gray Positive Transflective Normal Temp.
Driver Condition	LCD Module : 1/16 Duty , 1/5 Bias
Viewing Direction	6 O'clock
Backlight	YG LED B/L
Weight	13 g
Interface	-
ROHS	THIS PRODUCT CONFORMS THE ROHS OF PTC Detail information please refer web side : http://www.powertip.com.tw/news/LatestNews.asp

1.2 Mechanical Specifications

Item	Standard Value	Unit
Outline Dimension	53.0(L) * 20.0(w) * 8.6(H)(Max)	mm
Viewing Area	36.0(L) * 10.0(w)	mm
Active Area	34.1(L) * 7.4(w)	mm
Dot Size	0.33(L) * 0.35(w)	mm
Dot Pitch	0.38(L) * 0.40(w)	mm

Note : For detailed information please refer to LCM drawing

1.3 Absolute Maximum Ratings

Item	Symbol	Condition	Min.	Max.	Unit
Power Supply Voltage	V _{DD}	—	-0.3	7.0	V
LCD Driver Supply Voltage	V _{LCD}	—	V _{DD} -10.0	V _{DD} +0.3	V
Input Voltage	V _{IN}	—	-0.3	V _{DD} +0.3	V
Operating Temperature	T _{OP}	Excluded B/L	0	50	°C
Storage Temperature	T _{ST}	Excluded B/L	-20	70	°C
Storage Humidity	H _D	Ta < 40 °C	-	90	%RH

1.4 DC Electrical Characteristics

$V_{DD} = 5.0 \text{ V} \pm 10\%$, $V_{SS} = 0\text{V}$, $T_a = 25^\circ\text{C}$

Item	Symbol	Condition	Min.	Typ.	Max.	Unit
Logic Supply Voltage	V_{DD}	—	4.5	5.0	5.5	V
“H” Input Voltage	V_{IH}	—	$0.7 V_{DD}$	-	V_{DD}	V
“L” Input Voltage	V_{IL}	—	-0.3	-	0.6	V
“H” Output Voltage	V_{OH}	$I_{OH} = -0.1\text{mA}$	3.9	-	V_{DD}	V
“L” Output Voltage	V_{OL}	$I_{OL} = 0.1\text{mA}$	-	-	0.4	V
Supply Current	I_{DD}	$V_{DD} = 5.0 \text{ V}$	-	1.5	3.0	mA
LCM Driver Voltage	V_{OP}	0°C	-	-	-	V
		25°C *1	4.2	4.4	4.6	
		50°C	-	-	-	

Note: *1. THE V_{OP} TEST POINT IS $V_{DD} - V_O$.

1.5 Optical Characteristics

LCD Panel : 1/16 Duty , 1/5 Bias , $V_{LCD} = 4.67 \text{ V}$, $T_a = 25^\circ\text{C}$

Item	Symbol	Conditions	Min.	Typ.	Max.	Reference
View Angle	θ	$C \geq 2.0, \varnothing = 0^\circ$	0°	-	40°	Notes 1 & 2
Contrast Ratio	C	$\theta = 5^\circ, \varnothing = 0^\circ$	5	7	-	Note 3
Response Time(rise)	t_r	$\theta = 5^\circ, \varnothing = 0^\circ$	-	150 ms	-	Note 4
Response Time(fall)	t_f	$\theta = 5^\circ, \varnothing = 0^\circ$	-	330 ms	-	Note 4

Note 1: Definition of angles θ and \varnothing

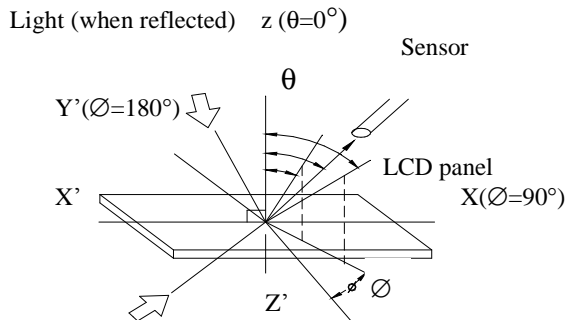

Light (when transmitted) $Y (\varnothing=0^\circ)$
 $(\theta=90^\circ)$

Note 2: Definition of viewing angles θ_1 and θ_2

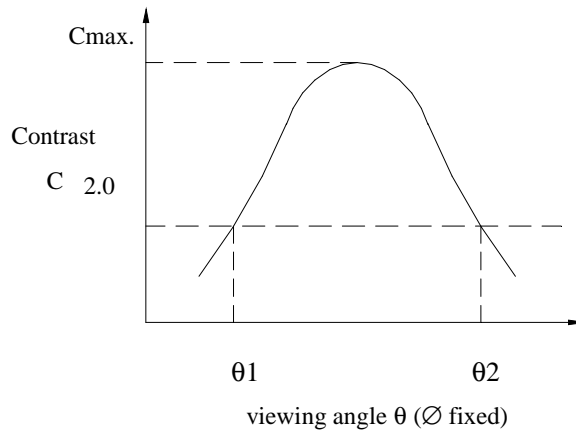

Note : Optimum viewing angle with the naked eye and viewing angle θ at Cmax. Above are not always the same

Note 3: Definition of contrast C

$$C = \frac{\text{Brightness (reflection) of unselected dot (B2)}}{\text{Brightness (reflection) of selected dot (B1)}}$$

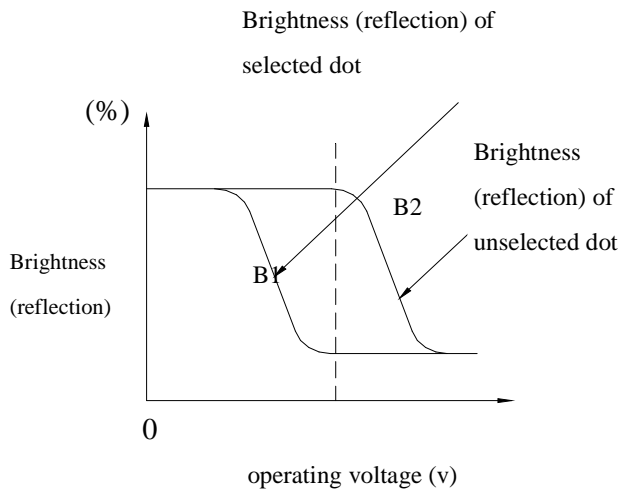

Note 4: Definition of response time

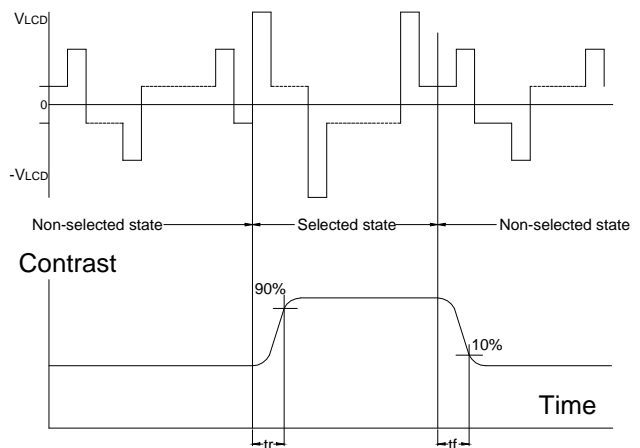

Note: Measured with a transmissive LCD panel which is displayed 1 cm²

V_{LCD} : Operating voltage f_{FRM} : Frame frequency

t_r : Response time (rise) t_f : Response time (fall)

1.6 Backlight Characteristics

LCD Module with LED Backlight

Maximum Ratings

Item	Symbol	Conditions	Min.	Max.	Unit
Forward Current	IF	Ta =25°C	-	40	mA
Reverse Voltage	VR	Ta =25°C	-	8	V
Power Dissipation	PO	Ta =25°C	-	0.19	W

Electrical / Optical Characteristics

Ta =25°C

Item	Symbol	Conditions	Min.	Typ.	Max.	Unit
Forward Voltage	VF	IF= 28 mA	-	4.2	4.8	V
Reverse Current	IR	VR= 8 V	-	-	0.2	mA
Wavelength	λp	IF= 28 mA	565	-	571	nm
Luminous Intensity (without LCD)	IV	IF= 28 mA	4	5	-	cd/m ²
Color	Yellow-green					

2. MODULE STRUCTURE

2.1 Counter Drawing

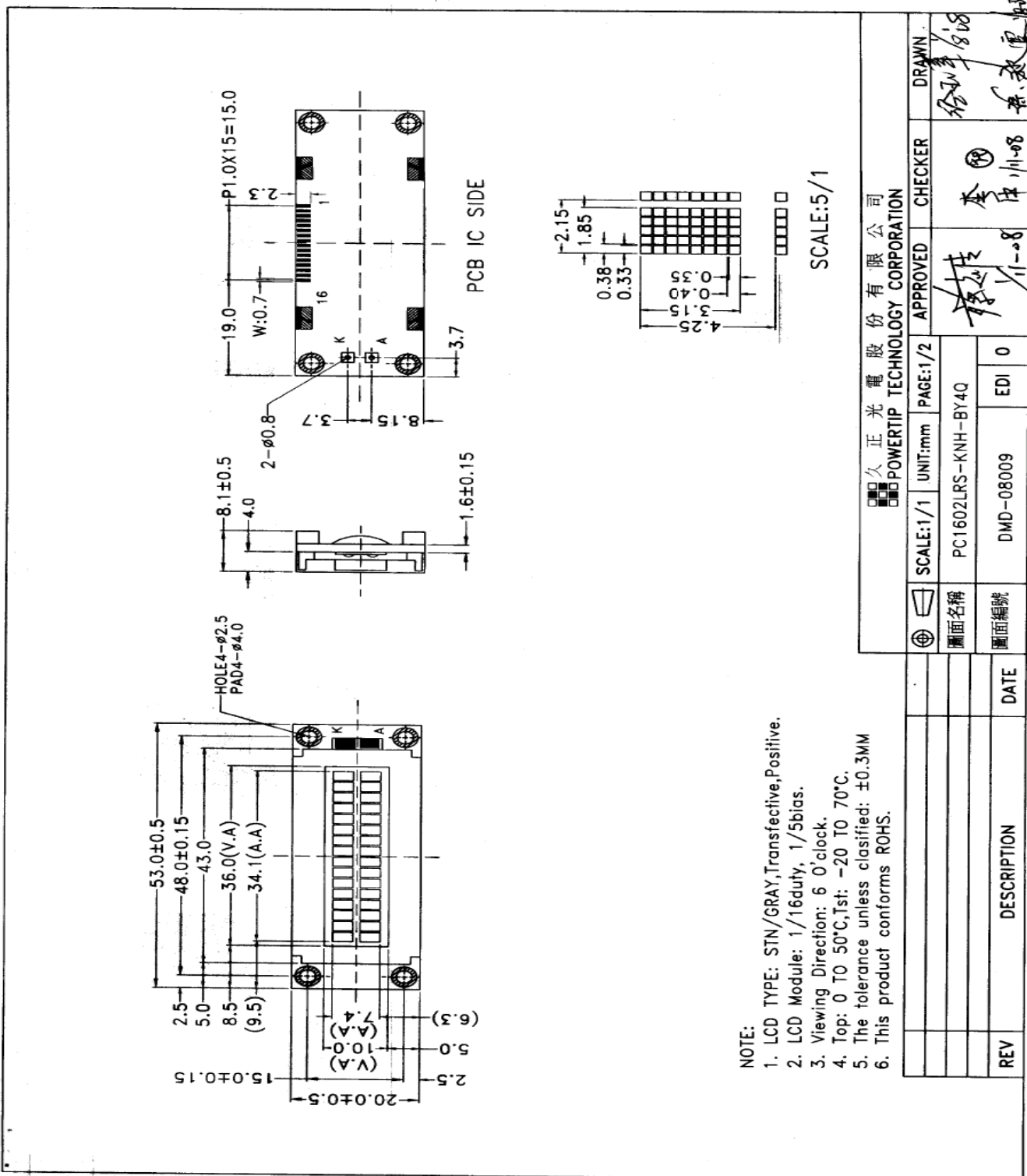



POWERTIP

PIN NO.	SIGNAL
1	Vss
2	Vdd
3	Vo
4	RS
5	R/W
6	E
7	DB0
8	DB1
9	DB2
10	DB3
11	DB4
12	DB5
13	DB6
14	DB7
15	A
16	K

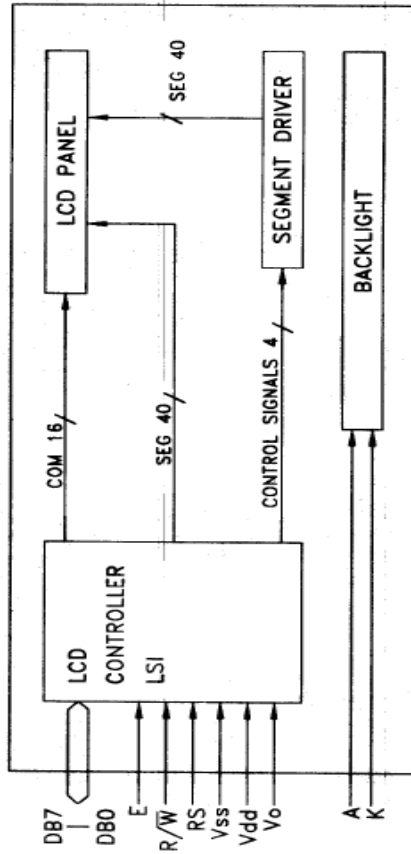

久正光電股份有限公司
POWERTIP TECHNOLOGY CORPORATION

REV	DESCRIPTION	DATE	圖面編號	圖面名稱	SCALE:NO	UNIT:NO	PAGE:2/2	APPROVED	CHECKER	DRAWN
			DMD-08009 <td>PC1602LRS-KNH-BY4Q <td></td> <td></td> <td></td> <td>李宇中 11-08</td> <td>李宇中</td> <td>徐志平 11-08</td> </td>	PC1602LRS-KNH-BY4Q <td></td> <td></td> <td></td> <td>李宇中 11-08</td> <td>李宇中</td> <td>徐志平 11-08</td>				李宇中 11-08	李宇中	徐志平 11-08
			EDI 0							徐志平 11-08

DT B 210-1

2.2 Interface Pin Description

Pin No.	Symbol	Function
1	Vss	Signal ground (GND)
2	VDD	Power Supply for logic (VDD> Vss)
3	VO	Operating Voltage for LCD (variable)
4	RS	Register selection input High = Data register Low = Instruction register (for write) Busy flag address counter (for read)
5	— R/W	R/W signal input is used to select the read/write mode High = Read mode, Low = Write mode
6	E	Start enable signal to read or write the data
7-10	DB0 ~ DB3	Four low order bi-directional three-state data bus lines. Used for data transfer between the MPU and the LCD module. These four are not used during 4-bit operation.
11~14	DB4~DB7	Four high order bi-directional three-state data bus lines. Used for data transfer between the MPU and the LCD module. DB7 can be used as a busy flag.
15	A	Power supply LED backlight (+)
16	K	Power supply LED backlight (-)

Contrast Adjust

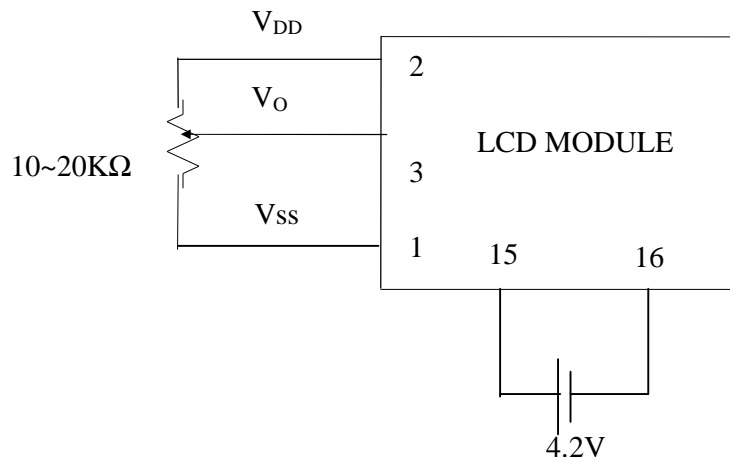

2.3 Timing Characteristics

- Read cycle

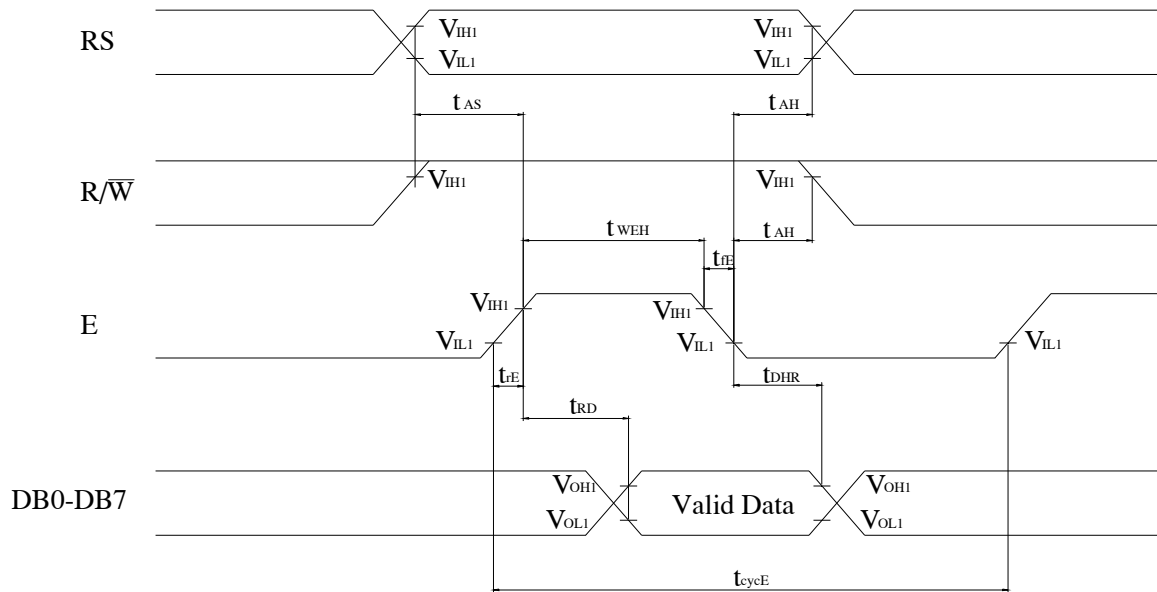

- Write cycle

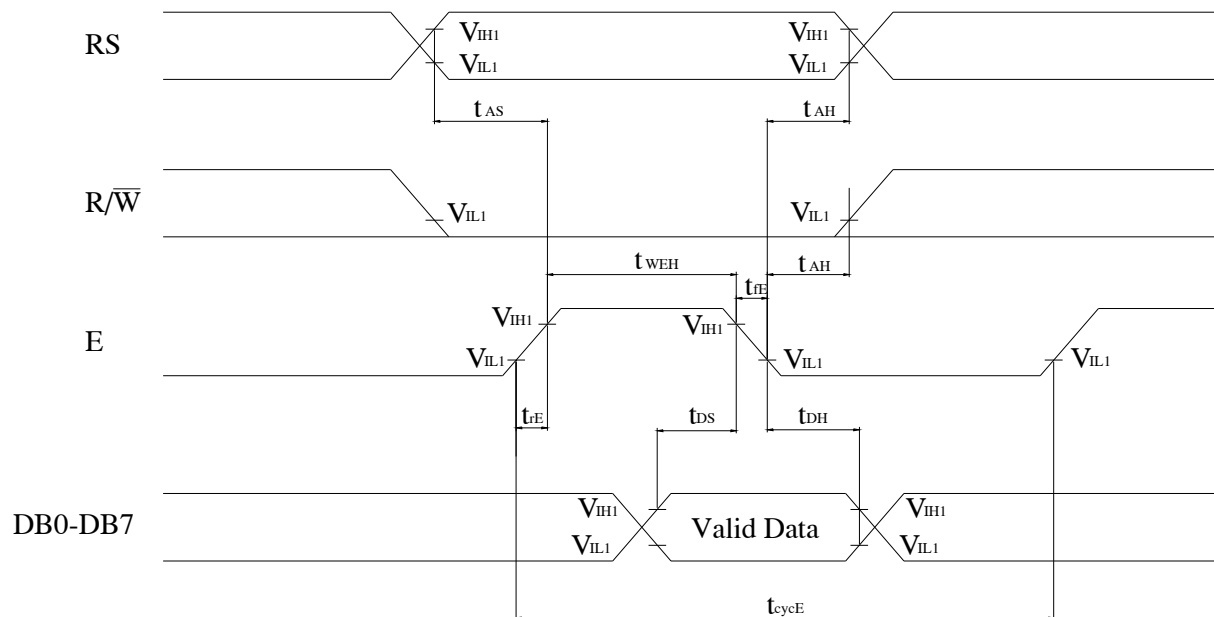

- Read cycle

VDD=5.0V±10%, VSS=0V, Ta=25°C

Characteristics	Symbol	Condition	Min.	Typ.	Max.	Unit
Enable cycle time	t_{cycE}	-	500	-	-	ns
Enable "H" level pulse width	t_{WEH}	-	300	-	-	ns
Enable rise/fall time	t_{rE}, t_{fE}	-	-	-	25	ns
RS,R/W setup time	t_{AS}	-	60 ¹	-	-	ns
			100 ²			
RS,R/W address hold time	t_{AH}	-	10	-	-	ns
Read data output delay	t_{RD}	$C_L=100pF$	-	-	190	ns
Read data hold time	t_{DHR}	-	20	-	-	ns

- Write cycle

Characteristics	Symbol	Condition	Min.	Typ.	Max.	Unit
Enable cycle time	t_{cycE}	-	500	-	-	ns
Enable "H" level pulse width	t_{WEH}	-	300	-	-	ns
Enable rise/fall time	t_{rE}, t_{fE}	-	-	-	25	ns
RS,R/W setup time	t_{AS}	-	60 ¹	-	-	ns
			100 ²			
RS,R/W address hold time	t_{AH}	-	10	-	-	ns
Data setup time	t_{DS}	-	100	-	-	ns
Write data hold time	t_{DH}	-	10	-	-	ns

Notes: 1: 8-bit operation mode

2: 4-bit operation mode

2.4 Display Command

Instructions	Instruction Code										Description	Execution Time(max) ($f_{oc}=250\text{KHZ}$)
	RS	R/W	DB7	DB6	DB5	DB4	DB3	DB2	DB1	DB0		
Clear Display	0	0	0	0	0	0	0	0	0	1	Clear entire display area, restore display from shift, and load address counter with DD RAM address 00H	1.64ms
Display/ Cursor Home	0	0	0	0	0	0	0	0	1	×	Restore display from shift and load address counter with DD RAM address 00H	1.64ms
Entry Mode Set	0	0	0	0	0	0	0	1	I/D	S	Specify direction of cursor movement and display shift mode. This operation takes place after each data transfer (read/write)	40 μ s
Display ON/OFF Control	0	0	0	0	0	0	1	D	C	B	Specify activation of display (D) cursor (C) and blinking of character at cursor position (B).	40 μ s
Display/ Cursor Shift	0	0	0	0	0	1	S/C	R/L	×	×	Shift display or move cursor.	40 μ s
Function Set	0	0	0	0	1	DL	N	F	×	×	Set interface data length (D), number of display line (N), and character font (F).	40 μ s
RAM Address Set	0	0	0	1	ACG					Load the address counter with a CG RAM address. Subsequent data access is for CG RAM data.		40 μ s
DD RAM Address Set	0	0	1	ADD					Load the address counter with a DD RAM address. Subsequent data access is for DD RAM data.		40 μ s	
Busy Flag/Address Counter Read	0	1	AC					Read Busy Flag (BF) and contents of Address Counter (AC).		40 μ s		
CG RAM/DD RAM Data Write	1	0	Write data					Write data to CG RAM or DD RAM.		40 μ s		
CG RAM/DD RAM Data Read	1	1	Read data					Read data from CG RAM or DD RAM		40 μ s		

Note 1: Symbol “*” signifies an insignificant bit (disregards).

Note 2: Correct input value for “N” is predetermined for each model.

2.5 Character Pattern

■ CHARACTER PATTERN(SH/EH,NH)

Upper 8 Bits Lower 4 Bits	LLLL	LLHL	LLHH	LHLL	LHLH	LHHL	LHHH	HLLL	HLLH	HLHL	HLHH	HHLL	HHLH	HHHL	HHHH
LLLL	CG RAM (1)														
LLLH	(2)														
LLHL	(3)														
LLHH	(4)														
LHLL	(5)														
LHLH	(6)														
LHHL	(7)														
LHHH	(8)														
HLLL	(1)														
HLLH	(2)														
HLHL	(3)														
HLHH	(4)														
HHLL	(5)														
HHLH	(6)														
HHHL	(7)														
HHHH	(8)														

3. QUALITY ASSURANCE SYSTEM

3.1 Quality Assurance Flow Chart

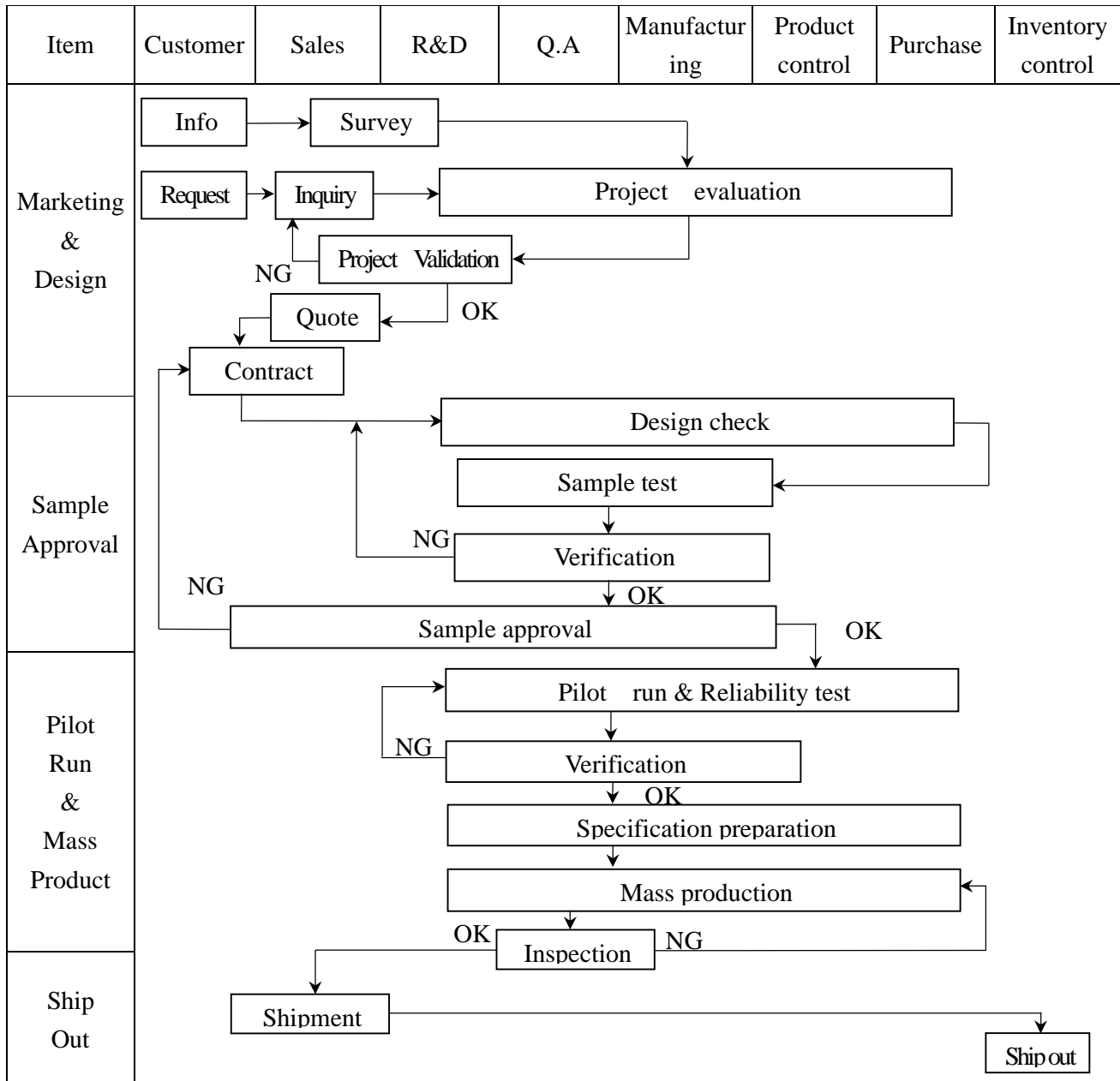

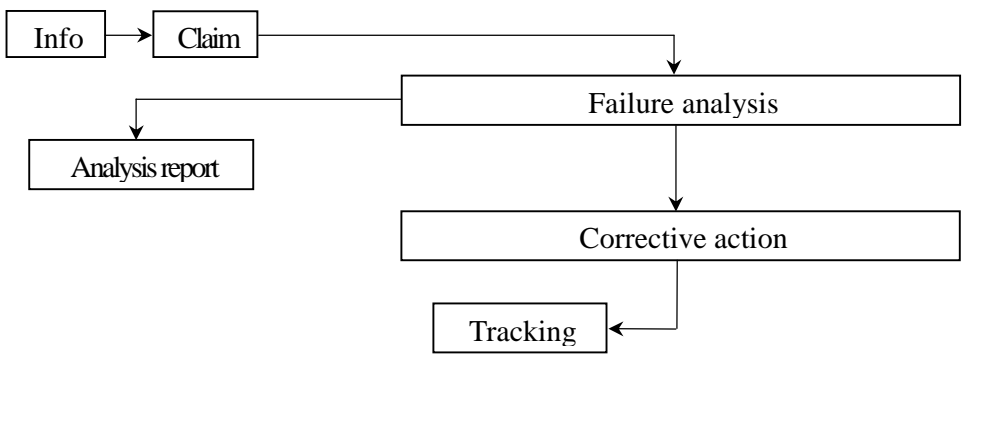
Item	Customer	Sales	R&D	Q.A	Manufacturing	Product control	Purchase	Inventory control
Sales Service	 <pre> graph TD Info[Info] --> Claim[Claim] Claim --> FA[Failure analysis] Claim --> AR[Analysis report] FA --> CA[Corrective action] CA --> Tracking[Tracking] </pre>							
Q.A Activity	1. ISO 9001 Maintenance Activities 3. Equipment calibration 5. Standardization Management				2. Process improvement proposal 4. Education And Training Activities			

3.2 Inspection Specification

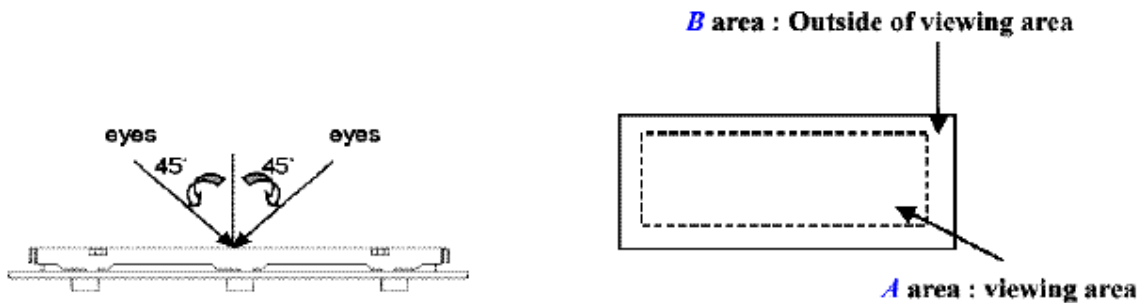

- ◆ Inspection Standard : MIL-STD-105E Table Normal Inspection Single Sampling Level II .
- ◆ Equipment : Gauge 、 MIL-STD 、 Powertip Tester 、 Sample
- ◆ Defect Level : Major Defect AQL 0.4; Minor Defect AQL 1.5 .
- ◆ OUT Going Defect Level : Sampling .
- ◆ Manner of appearance test :
 - (1). The test be under 40W×2 fluorescent light ' and distance of view must be at 30 cm.
 - (2). The test direction is base on about around 45° of vertical line. (Fig. 1)
 - (3). Definition of area . (Fig. 2)



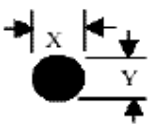
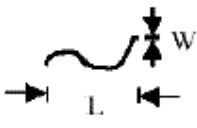

◆ Specification:

NO	Item	Criterion	level
01	Product condition	1.1 The part number is inconsistent with work order of Production.	Major
		1.2 Mixed production types.	Major
		1.3 Assembled in inverse direction.	Major
02	Quantity	2.1 The quantity is inconsistent with work order of production.	Major
03	Outline dimension	3.1 Product dimension and structure must conform to Structure diagram.	Major
04	Electrical Testing	4.1 Missing line character 、 dot and icon.	Major
		4.2 No function or no display.	Major
		4.3 Output data is error.	Major
		4.4 LCD viewing angle defect.	Major
		4.5 Current consumption exceeds product specifications.	Major
05	Black or white dot 、 scratch 、 contamination Round type	5.1 Round type: 5.1.1 display only : <ul style="list-style-type: none"> • White and black spots on display $\leq 0.30\text{mm}$, no more than Four white or black spots present. • Densely spaced : NO more than two spots or lines within 3mm 	Minor

◆Specification :

NO	Item	Criterion	level																																	
05	Black or white dot、scratch、contamination Round type  $\Phi = (x+y)/2$ 	5.1.2 Nom-display : <table border="1" data-bbox="552 430 1315 640"> <thead> <tr> <th>Dimension (diameter : Φ)</th> <th>Acceptance(Q'ty)</th> </tr> </thead> <tbody> <tr> <td>$\Phi \leq 0.10\text{mm}$</td> <td>Accept no dense</td> </tr> <tr> <td>$0.10\text{mm} < \Phi \leq 0.20\text{mm}$</td> <td>3</td> </tr> <tr> <td>$0.20\text{mm} < \Phi \leq 0.30\text{mm}$</td> <td>2</td> </tr> <tr> <td>Total</td> <td>4</td> </tr> </tbody> </table> 5.1.3 Line type: <table border="1" data-bbox="462 703 1380 945"> <thead> <tr> <th colspan="2">Dimension (diameter : Φ)</th> <th colspan="2">Acceptance (Q'ty)</th> </tr> <tr> <th>Length</th> <th>width</th> <th>A area</th> <th>B area</th> </tr> </thead> <tbody> <tr> <td>---</td> <td>$w \leq 0.03\text{mm}$</td> <td>Accept no dense</td> <td>Don't count</td> </tr> <tr> <td>$L \leq 3.0\text{mm}$</td> <td>$0.03\text{mm} < \Phi \leq 0.05\text{mm}$</td> <td rowspan="2">4</td> <td>Don't count</td> </tr> <tr> <td>$L \leq 2.5\text{mm}$</td> <td>$0.05\text{mm} < \Phi \leq 0.075\text{mm}$</td> <td>Don't count</td> </tr> <tr> <td>---</td> <td>$w > 0.075\text{mm}$</td> <td colspan="2">As round type</td> </tr> </tbody> </table>	Dimension (diameter : Φ)	Acceptance(Q'ty)	$\Phi \leq 0.10\text{mm}$	Accept no dense	$0.10\text{mm} < \Phi \leq 0.20\text{mm}$	3	$0.20\text{mm} < \Phi \leq 0.30\text{mm}$	2	Total	4	Dimension (diameter : Φ)		Acceptance (Q'ty)		Length	width	A area	B area	---	$w \leq 0.03\text{mm}$	Accept no dense	Don't count	$L \leq 3.0\text{mm}$	$0.03\text{mm} < \Phi \leq 0.05\text{mm}$	4	Don't count	$L \leq 2.5\text{mm}$	$0.05\text{mm} < \Phi \leq 0.075\text{mm}$	Don't count	---	$w > 0.075\text{mm}$	As round type		Minor
Dimension (diameter : Φ)	Acceptance(Q'ty)																																			
$\Phi \leq 0.10\text{mm}$	Accept no dense																																			
$0.10\text{mm} < \Phi \leq 0.20\text{mm}$	3																																			
$0.20\text{mm} < \Phi \leq 0.30\text{mm}$	2																																			
Total	4																																			
Dimension (diameter : Φ)		Acceptance (Q'ty)																																		
Length	width	A area	B area																																	
---	$w \leq 0.03\text{mm}$	Accept no dense	Don't count																																	
$L \leq 3.0\text{mm}$	$0.03\text{mm} < \Phi \leq 0.05\text{mm}$	4	Don't count																																	
$L \leq 2.5\text{mm}$	$0.05\text{mm} < \Phi \leq 0.075\text{mm}$		Don't count																																	
---	$w > 0.075\text{mm}$	As round type																																		
06	Polarizer Bubble	<table border="1" data-bbox="462 1018 1372 1333"> <thead> <tr> <th rowspan="2">Dimension (diameter : Φ)</th> <th colspan="2">Acceptance(Q'ty)</th> </tr> <tr> <th>A area</th> <th>B area</th> </tr> </thead> <tbody> <tr> <td>$\Phi \leq 0.20\text{mm}$</td> <td>Accept no dense</td> <td>Don't count</td> </tr> <tr> <td>$0.20\text{mm} < \Phi \leq 0.50\text{mm}$</td> <td>3</td> <td>Don't count</td> </tr> <tr> <td>$0.50\text{mm} < \Phi \leq 1.00\text{mm}$</td> <td>2</td> <td>Don't count</td> </tr> <tr> <td>$\Phi > 1.00\text{mm}$</td> <td>0</td> <td>Don't count</td> </tr> <tr> <td>Total quantity</td> <td>4</td> <td>Don't count</td> </tr> </tbody> </table>	Dimension (diameter : Φ)	Acceptance(Q'ty)		A area	B area	$\Phi \leq 0.20\text{mm}$	Accept no dense	Don't count	$0.20\text{mm} < \Phi \leq 0.50\text{mm}$	3	Don't count	$0.50\text{mm} < \Phi \leq 1.00\text{mm}$	2	Don't count	$\Phi > 1.00\text{mm}$	0	Don't count	Total quantity	4	Don't count	Minor													
Dimension (diameter : Φ)	Acceptance(Q'ty)																																			
	A area	B area																																		
$\Phi \leq 0.20\text{mm}$	Accept no dense	Don't count																																		
$0.20\text{mm} < \Phi \leq 0.50\text{mm}$	3	Don't count																																		
$0.50\text{mm} < \Phi \leq 1.00\text{mm}$	2	Don't count																																		
$\Phi > 1.00\text{mm}$	0	Don't count																																		
Total quantity	4	Don't count																																		
07	The crack of glass	<ul style="list-style-type: none"> ● Glass Crack: 7.1 Crack on the circuit of electrode terminal :  <table border="1" data-bbox="527 1690 1315 1827"> <thead> <tr> <th></th> <th>X</th> <th>Y</th> <th>Z</th> </tr> </thead> <tbody> <tr> <td>Front</td> <td>$X \leq 1/5 a$</td> <td>$Y \leq 1/2 D$</td> <td>$Z \leq t$</td> </tr> <tr> <td>Back</td> <td colspan="3">Neglect</td> </tr> </tbody> </table>		X	Y	Z	Front	$X \leq 1/5 a$	$Y \leq 1/2 D$	$Z \leq t$	Back	Neglect			Minor																					
	X	Y	Z																																	
Front	$X \leq 1/5 a$	$Y \leq 1/2 D$	$Z \leq t$																																	
Back	Neglect																																			

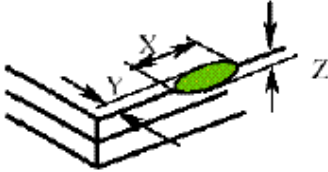
◆ Specification :

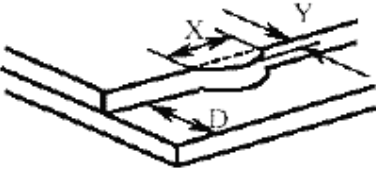
NO	Item	Criterion	Level												
07	<p>The crack of glass</p> <p>X: The length of Crack</p> <p>Y: The width of crack</p> <p>Z: The thickness of crack</p> <p>D: terminal length</p> <p>T: The thickness of glass</p> <p>A : The length of glass</p>	<p>● Glass Crack:</p> <p>7.2 General glass crack and corner edge:</p> <p>7.2.1</p>  <table border="1" data-bbox="586 774 1255 869"> <tr> <td>X</td> <td>Y</td> <td>Z</td> </tr> <tr> <td>Neglect</td> <td>Out A area</td> <td>Neglect</td> </tr> </table> <p>7.2.2</p>  <table border="1" data-bbox="586 1125 1255 1220"> <tr> <td>X</td> <td>Y</td> <td>Z</td> </tr> <tr> <td>Neglect</td> <td>Out A area</td> <td>Neglect</td> </tr> </table>	X	Y	Z	Neglect	Out A area	Neglect	X	Y	Z	Neglect	Out A area	Neglect	Minor
X	Y	Z													
Neglect	Out A area	Neglect													
X	Y	Z													
Neglect	Out A area	Neglect													
		<p>7.3 Glass remain:</p>  <table border="1" data-bbox="724 1669 1146 1764"> <tr> <td>X</td> <td>Y</td> </tr> <tr> <td>Neglect</td> <td>$\leq 1/3 d$</td> </tr> </table>	X	Y	Neglect	$\leq 1/3 d$	Minor								
X	Y														
Neglect	$\leq 1/3 d$														

◆Specification :

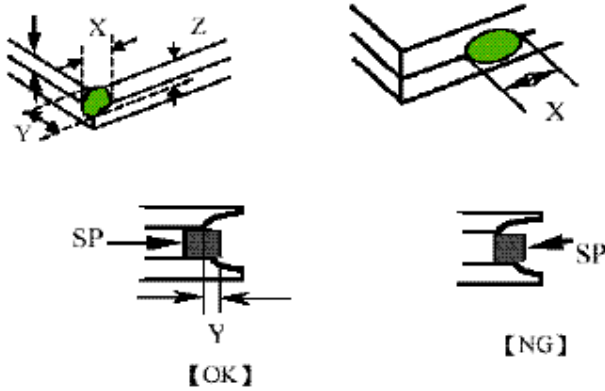
NO	Item	Criterion	Level									
07	<p>The crack of glass</p> <p>X: The length of Crack</p> <p>Y: The width of crack</p> <p>Z: The thickness of crack</p> <p>D: terminal length</p> <p>T: The thickness of glass</p> <p>A : The length of glass</p>	<p>7.4 Corner crack and medial crack:</p>  <table border="1" data-bbox="483 997 1367 1180"> <thead> <tr> <th>X</th> <th>Y</th> <th>Z</th> </tr> </thead> <tbody> <tr> <td>$\leq 1/5a$</td> <td>Crack can't enter viewing area</td> <td>$\leq 1/2t$</td> </tr> <tr> <td>$\leq 1/5a$</td> <td>Crack can't exceed the half of width of SP</td> <td>$1/2t < Z \leq 2t$</td> </tr> </tbody> </table>	X	Y	Z	$\leq 1/5a$	Crack can't enter viewing area	$\leq 1/2t$	$\leq 1/5a$	Crack can't exceed the half of width of SP	$1/2t < Z \leq 2t$	Minor
X	Y	Z										
$\leq 1/5a$	Crack can't enter viewing area	$\leq 1/2t$										
$\leq 1/5a$	Crack can't exceed the half of width of SP	$1/2t < Z \leq 2t$										
08	Backlight elements	8.1 Backlight can't work normally.	Major									
		8.2 Backlight doesn't light or color is wrong.	Major									
		8.3 Illumination source flickers when lit.	Major									
09	General appearance	9.1 pin type must match type in specification sheet	Major									
		9.2 No short circuits in components on PCB or FPC	Major									
		9.3 Product packaging must the same as specified on packaging specification sheet.	Major									
		9.4 The folding and peeled off in polarizer are not acceptable	Major									
		9.5 The PCB or FPC between B/L assembled distance (PCB or FPC) is $\leq 1.5\text{mm}$	Major									

4. RELIABILITY TEST

4.1 Reliability Test Condition

NO.	TEST ITEM	TEST CONDITION										
1	High Temperature Storage Test	Keep in 70 ±2°C 96 hrs Surrounding temperature, then storage at normal condition 4hrs										
2	Low Temperature Storage Test	Keep in -20 ±2°C 96 hrs Surrounding temperature, then storage at normal condition 4hrs										
3	High Humidity Storage	Keep in +40°C/90%RH duration for 96 hrs Surrounding temperature, then storage at normal condition 4hrs (Excluding the polarizer)										
4	ESD Test	<table border="1" style="width: 100%;"> <tr> <td style="width: 50%;">Air Discharge: Apply 6 KV with 5 times Discharge for each polarity +/-</td> <td style="width: 50%;">Contact Discharge: Apply 250V with 5 times discharge for each polarity +/-</td> </tr> </table>	Air Discharge: Apply 6 KV with 5 times Discharge for each polarity +/-	Contact Discharge: Apply 250V with 5 times discharge for each polarity +/-								
		Air Discharge: Apply 6 KV with 5 times Discharge for each polarity +/-	Contact Discharge: Apply 250V with 5 times discharge for each polarity +/-									
<ol style="list-style-type: none"> 1. Temperature Ambient:15°C ~ 35°C 2. Humidity relative:30% ~ 60% 3. Energy Storage Capacitance(Cs+Cd):150pF±10% 4. Discharge Resistance(Rd):330 Ω±10% 5. Discharge, mode of operation: Single Discharge (time between successive discharges at least 1 s) (Tolerance If the output voltage indication: ±5%) 												
5	Temperature Cycling Test	$-20^{\circ}\text{C} \rightarrow 25^{\circ}\text{C} \rightarrow 70^{\circ}\text{C} \rightarrow 25^{\circ}\text{C}$ $\xleftarrow{\text{(30mins) (5mins) (30mins) (5mins)}} \xrightarrow{\text{10 Cycle}}$										
6	Vibration Test (Packaged)	<ol style="list-style-type: none"> 1. Sine wave 10~55HZ frequency (1 min) 2. The amplitude of vibration :1.5 mm 3. Each direction (XYZ) duration for 2 Hrs 										
7	Drop Test (Packaged)	<table border="1" style="width: 100%; text-align: center;"> <thead> <tr> <th>Packing Weight (Kg)</th> <th>Drop Height (cm)</th> </tr> </thead> <tbody> <tr> <td>0 ~ 45.4</td> <td>122</td> </tr> <tr> <td>45.4 ~ 90.8</td> <td>76</td> </tr> <tr> <td>90.8 ~ 454</td> <td>61</td> </tr> <tr> <td>Over 454</td> <td>46</td> </tr> </tbody> </table>	Packing Weight (Kg)	Drop Height (cm)	0 ~ 45.4	122	45.4 ~ 90.8	76	90.8 ~ 454	61	Over 454	46
		Packing Weight (Kg)	Drop Height (cm)									
0 ~ 45.4	122											
45.4 ~ 90.8	76											
90.8 ~ 454	61											
Over 454	46											
		Drop direction : ※3 comer /1 edges /6 sides etch 1times										

5. PRECAUTION RELATING PRODUCT HANDLING

5.1 SAFETY

- 5.1.1 If the LCD panel breaks , be careful not to get the liquid crystal to touch your skin.
- 5.1.2 If the liquid crystal touches your skin or clothes , please wash it off immediately by using soap and water.

5.2 HANDLING

- 5.2.1 Avoid any strong mechanical shock which can break the glass.
- 5.2.2 Avoid static electricity which can damage the CMOS LSI—When working with the module , be sure to ground your body and any electrical equipment you may be using.
- 5.2.3 Do not remove the panel or frame from the module.
- 5.2.4 The polarizing plate of the display is very fragile. So , please handle it very carefully ,do not touch , push or rub the exposed polarizing with anything harder than an HB pencil lead (glass , tweezers , etc.)
- 5.2.5 Do not wipe the polarizing plate with a dry cloth , as it may easily scratch the surface of plate.
- 5.2.6 Do not touch the display area with bare hands , this will stain the display area.
- 5.2.7 Do not use ketonics solvent & aromatic solvent. Use with a soft cloth soaked with a cleaning naphtha solvent.
- 5.2.8 To control temperature and time of soldering is $320\pm 10^{\circ}\text{C}$ and 3-5 sec.
- 5.2.9 To avoid liquid (include organic solvent) stained on LCM .

5.3 STORAGE

- 5.3.1 Store the panel or module in a dark place where the temperature is $25^{\circ}\text{C} \pm 5^{\circ}\text{C}$ and the humidity is below 65% RH.
- 5.3.2 Do not place the module near organics solvents or corrosive gases.
- 5.3.3 Do not crush , shake , or jolt the module.

5.4 TERMS OF WARRANTY

- 5.4.1 Applicable warrant period
The period is within thirteen months since the date of shipping out under normal using and storage conditions.
- 5.4.2 Unaccepted responsibility
This product has been manufactured to your company's specification as a part for use in your company's general electronic products. It is guaranteed to perform according to delivery specifications. For any other use apart from general electronic equipment , we cannot take responsibility if the product is used in nuclear power control equipment , aerospace equipment , fire and security systems or any other applications in which there is a direct risk to human life and where extremely high levels of reliability are required.

6. PACKING Specification

LCM Model	PC1602LRS-KNH-BY4Q	LCM包裝規格書	Approve	Check	Contact
Drawing NO.	DPK-07882	LCM Packaging Specifications	周子明 2013/08	張永興	胡榮
			DATE	初版 Ver	版次 Ver
			07'12'25	07'12'25	0

1. 包裝材料規格表 (Packaging Material) : (per carton)

No.	Item	Model	Dimensions (mm)	Quantity
1	成品(1) LCM	PC1602LRS-KNH-BY4Q	(53.0*20.0*8.1)	540
2	靜電袋 (2)BAG	BAG100100ARABA	100*100*0.05	540
3	氣泡墊(3)BAG	BAG290240BRBBA	240*290*5	24
4	刀卡A1(4)BX	BX29500047BZBA	295*47*3	168
5	刀卡B1(5)BX	BX24500047BZBA	245*47*4.5	48
6	C1內盒(6)Product Box	BX31025555AABA	310*255*55	12
7	外紙箱(7)Carton	BX52532536CCBA	525*325*360	1
8				
9				

2. 單箱數量規格表 (Packaging Specifications and Quantity) :

(1) LCM quantity per box : no. per box 15 x no. of box 3 = 45

(2) Total LCM quantity in carton : quantity per box 45 x no. of boxes 12 = 540



特 記 事 項 (REMARK)

<p>1. Label Specifications :</p> <div style="border: 1px solid black; padding: 5px; margin-top: 5px;"> MODEL: LOT NO: QUANTITY: CHECK: </div>		<p>最外一欄LCD面朝里,其餘LCD面 朝外,CB pin朝下),45PCS/盒</p>
--------------------------------------------------------------------------------------------------------------------------------------------------------------	--	---------------------------------------------------