

## I. APPLICATIONS

1. Great for desoldering & soldering applications on a broad range of components. Applicable components include SOIC, CHIP, QFP, PLCC, BGA, SMD. On top of that, the station is especially suitable for desoldering in-line sockets, transformers, LCD screens, nixie tube screens, IC chips, and in-line headers.
2. The unit's applications include heat shrinking, drying, paint removal, glue removal, defrosting, pre-heating, glue soldering, and more.

## II. REFERENCE GRAPHS

### Display Guide

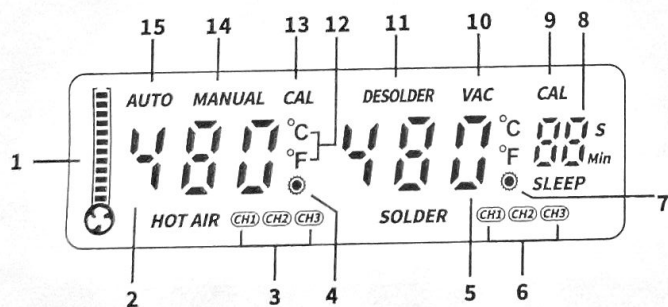

1. Air Volume (Simulated Value)
2. Temperature Display (Hot Air Rework Station)
3. Indicators for Preset Channels 1, 2 and 3 (Hot Air Rework Station)
4. Operation Indicator (Hot Air Rework Station)
5. Temperature Display (Desoldering/Soldering Station)
6. Indicators for Preset Channels 1, 2 and 3 (Desoldering/Soldering Station)
7. Operation Indicator (Desoldering/Soldering Station)
8. Count-Down Timer (Sleep Mode/Automatic Shutdown)
9. Calibration Indicator (Desoldering/Soldering Station)
10. Suction Pen Indicator
11. Desoldering Station Indicator
12. °F / °C Indicator
13. Calibration Indicator (Hot Air Rework Station)
14. Manual Mode Indicator (Hot Air Rework Station)
15. Automatic Mode Indicator (Hot Air Rework Station)

### Control Panel Guide

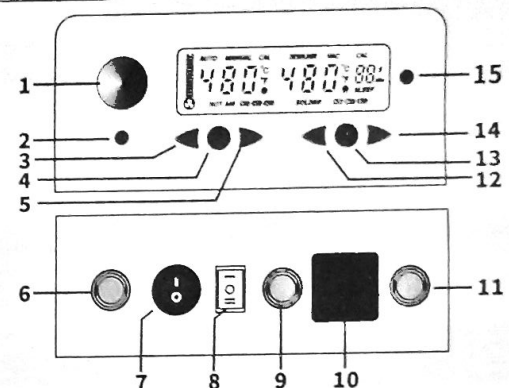

1. Air Volume Adjustment Knob / Hot or Cool Air Switch
2. Manual / Automatic Switch
3. Temperature Decrease Button (Hot Air Rework Station)
4. Function Button (Hot Air Rework Station)
5. Temperature Increase Button (Hot Air Rework Station)
6. Receptacle (Hot Air Gun)
7. Power Switch (Hot Air Rework Station)
8. Multi-purpose Power Switch for Desoldering/Soldering Station (Switch to O to turn OFF; I to turn on the desoldering station; II to turn on the Soldering Station)
9. Receptacle (Soldering Iron)
10. Vacuum Connector (Suction Pen/Desoldering Station)
11. Receptacle (Desoldering Gun)
12. Temperature Decrease Button (Desoldering/Soldering Station)
13. Function Button (Desoldering/Soldering Station)
14. Temperature Increase Button (Desoldering/Soldering Station)
15. Power Switch (Suction Pen)

### Schematic View of Desoldering Gun

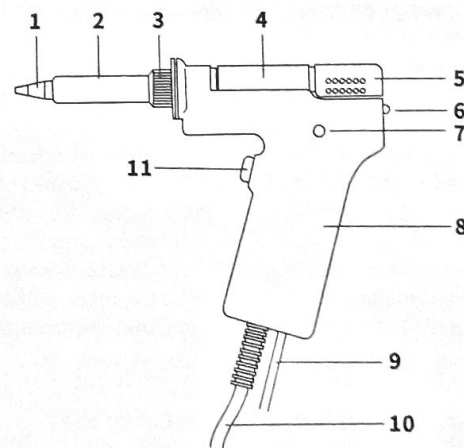

1. Desoldering Nozzle (Consumable Part)
2. Nozzle Enclosure
3. Fastener
4. Filter Tube
5. Tube Chamber
6. Release Button
7. Indicator
8. Casing
9. Vacuum Tube
10. Power Cord (Desoldering Station)
11. Trigger (Desoldering)

## SPECIFICATION

Control unit dimension	L280xW187xH135mm ±5mm
Operating ambient temperature	0°C~40°C/32°F~104°F
<b>Hot Air Rework Station</b>	
Airflow	Brushless fan with smooth air delivery
Air volume	≤120L/min
Temperature range	100°C~480°C/212°F~896°F
Display	Nixie LED
<b>Soldering Station</b>	
Temperature range	200°C~480°C/392°F~896°F
Display	Nixie LED
Soldering tip to ground resistance	<2 ohms
<b>Desoldering Station</b>	
Temperature range	380°C~480°C / 716°F~896°F
Display	Nixie LED
Suction Pressure	0.05MPa (measured from the nozzle)

## III. OPERATION

### Hot Air Rework Station

1. Set the rework station correctly. Install the hot air gun holder to the left side of the station, and place the hot air gun onto the holder.
2. Install the required nozzle (Use of large-diameter nozzles is recommended), and connect the station's power cord to an electrical outlet.
3. Turn ON the power switch, and the temperature display shows "---" to indicate the hot air gun in standby mode. Set the desired temperature by using the increase and decrease buttons, and then pick up the hot air gun. The hot air gun will enter its standard operation status, and the hot air gun's operation indicator light (the dot located at the bottom-right corner of the hot air rework station's display) turns ON. The indicator stays ON when the hot air gun is heating up, blinks rapidly when the temperature is stabilized and turns OFF when the hot air gun is cooling. Adjust the air volume adjustment knob to set the appropriate air volume, and begin operation once the temperature has stabilized. The operation indicator blinks rapidly when the temperature enters stabilization. At this point, the precision PID program tracks and compensates the hot air gun's actual temperature every millisecond. The hot air gun is now in the high-precision thermostatic state.

300

Program real-time temperature tracking & compensation indicator

4. When the operation is complete, place the hot air gun back to the holder. Turn OFF the power switch (hot air rework station), and the operation indicator of the hot air gun turns OFF. The hot air gun now enters cool air mode to cool the heating element. When the temperature drops below 100°C/212°F, the hot air rework station's temperature display turns OFF. If the station is not in use for an extended period, turn OFF the station's power switch and DISCONNECT the station's power plug.

### Desoldering Station

1. Connect the desoldering gun to the station.
2. Connect the station's power cord to an electrical outlet.
3. Turn ON the desoldering station's power switch, and the desoldering station's heating element will begin heating up. The desoldering station's operation indicator will turn ON, the indicator will stay ON when the desoldering gun is heating up, blink rapidly when the temperature is stabilized, and turn OFF when the desoldering gun is cooling off.

300

Program real-time temperature tracking & compensation indicator

**CAUTION:** Upon the first use of the desoldering nozzle, set the temperature to 380°C-716°F. When the nozzle is just hot enough to melt solder, coat the nozzle with a layer of solder (the use of rosin-core solder is recommended), then set the temperature to your desired value.

4. Press the temperature increase or decrease button to set the station to your desired temperature, and allow the station to complete the preheating procedure (the station will beep to prompt you that the preheating is complete) before you should begin desoldering operation. To desolder: cover the solder joint with the desoldering nozzle, and completely melt all the solder on the joint. Then, press the desoldering trigger to extract all the solder from the joint.
5. When the operation is complete, use a wet sponge or brass wool ball to clean the desoldering nozzle. Tin the nozzle with a new layer of solder again, then put the desoldering gun back to the holder, and turn OFF the desoldering station's power switch. If the station is not in use for an extended period, DISCONNECT the power cord.

### CAUTION:

Take note and follow the below tips when using the desoldering station

- A. Make sure all the solder in the solder joint are completely melted before pulling the desoldering trigger.
- B. If there are solder remains in the hole, resolder, then repeat the desoldering procedures.
- C. If the component's pin is stuck on the side of the hole causing incomplete solder extraction, resolder, then use the desoldering nozzle to move the component's pin by moving the nozzle back and forth. Once the component's pin is no longer in contact with the hole, pull the desoldering trigger, and extract all the solder from the joint.
- D. When the desoldering nozzle is not clogged, pull the desoldering trigger and observe the color of the gun's indicator. If the color is red or more than half the indicator is red, the nozzle, heating element, and filter tube require proper cleaning. If the color is blue or slightly red, no cleaning is required.

E. The desoldering nozzles come in different diameters. The large nozzles are suitable for large solder joints with large component pins. The small nozzles are suitable for small solder joints with small component pins. Select the most appropriate nozzle diameter for your work.

### Soldering Station

1. Connect the soldering iron handle to the station, and place the soldering iron into its holder.
2. Turn ON the desoldering / soldering station's power switch. The soldering iron's heating element will begin heating normally, and the station's operation indicator turns ON. The indicator light stays ON when the soldering iron is heating up, blinks rapidly when the temperature is stabilized, turns OFF when the soldering iron is cooling off. Begin with the operation when the soldering station's operation indicator blinks rapidly to indicate temperature stabilization.



Program real-time temperature tracking & compensation indicator

**CAUTION:** Upon the first use of the soldering iron tip, set the temperature to 250°C/482°F. When the iron is just hot enough to melt solder, coat the soldering iron tip with a layer of solder (the use of rosin-core solder is recommended), then set the temperature to your desired value.

3. When the operation is complete, use a wet sponge or brass wool ball to clean the soldering iron tip. Tin the soldering iron tip with a new layer of solder again, then put the soldering iron back to the holder, and turn OFF the soldering station power switch. If the station is not in use for an extended period, DISCONNECT the power cord.

### Suction Pen

**CAUTION:** When the desoldering gun is connected to the station, the suction pen CANNOT be used simultaneously.

1. Connect the suction pen's vacuum tube to the vacuum outlet.
2. Turn ON the soldering station's power switch (Toggle the power switch to the "I" pole, switch illustrated in reference: control panel guide), and press the "VAC." Button to activate the suction pen. Hold the suction pen in hand, and block the suction hole with a finger to enable suction.
3. Move the suction pen to ensure the suction pad completely covers the chip's surface, then, lift up the chip.
4. Release the finger blocking the suction hole to release the chip.
5. Press "VAC." again to turn OFF the suction pen.

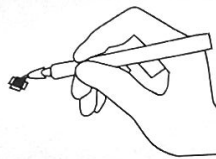
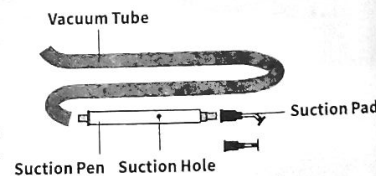

### Digital Temperature Calibration

Temperature discrepancies may occur due to the change in the environment's temperature or due to the replacement of the heating element and other components. You can correct the discrepancies with this function. The temperature calibration function can help improve work efficiency and prolong the lifespan of the soldering iron.

### Hot Air Rework Station

1. Turn ON the hot air rework station's power switch, and the hot air gun will begin heating up.
2. Press and hold the hot air rework station's function button for approximately 2 seconds, and the display will show value as shown in Graph 1. The station now enters the setting interface.
3. Press the temperature increase or decrease button to enter the digital temperature calibration interface. Wait for the display to show "--", then, press the automatic/manual button to jump between digits that you want to change. Press the temperature increase or decrease button to enter the measured temperature value, and then press the hot air rework station's function button to confirm. If minor discrepancies remain, repeat the calibration procedures.
4. Quickly press the function button 3 times to exit the setting interface - Temperature calibration complete.

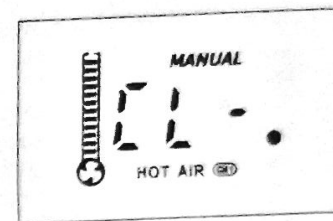

Graph 1

### Desoldering/Soldering Station Digital Temperature Calibration

1. Turn ON the desoldering / soldering station's power switch, then, the desoldering / soldering station's heating element will begin heating up.
2. Press and hold the desoldering station function button for approximately 2 seconds, and the display will show value as shown in graph 2.
3. Press both the desoldering station temperature increase and decrease buttons to enter the temperature calibration interface. Wait for the display to show "--", and press the suction pen power switch to jump between the digits you want to change. Press the desoldering station temperature increase or decrease button to enter the measured temperature value, then press the desoldering station function button to confirm entry. If minor temperature discrepancies remain, repeat the calibration procedure.
4. Quickly press the desoldering station function button 5 times to exit the temperature calibration interface.

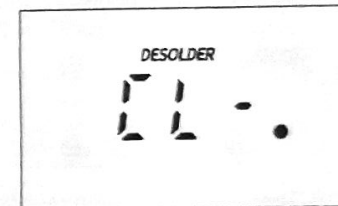

Graph 2

### For °C Temperature Display

This function allows the station to comply with user preferences in different regions.

1. Turn ON the hot air rework station's power switch.
2. Press and hold the hot air rework station's function button for approximately 2 seconds, and the display will show value as shown in Graph 1.

3. Press the hot air rework station's function button again, and the display will show value as shown in Graph 3, the indicator "C" will blink.
4. Press the hot air temperature increase or decrease button to switch between Fahrenheit / Celsius display mode, and then press hot air rework station's function button again to confirm selection and exit the setting interface—Setting complete.

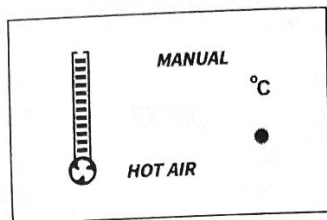

Graph 3

### Sleep Mode

This function helps extend the lifespan of the heating element, save energy, and protect the environment.

1. Turn ON the desoldering station's power switch.
2. Press and hold the desoldering station function button for approximately 2 seconds to enter the calibration interface. Press the desoldering station function button again to enter the sleep mode setting interface, the display will show value as shown in Graph 4, with "10" blinking.
3. Press the desoldering station temperature increase or decrease button to set the timer, and press the desoldering station function button to confirm setting.
4. Quickly press the desoldering station function button 3 times to exit the setting interface—setting complete.

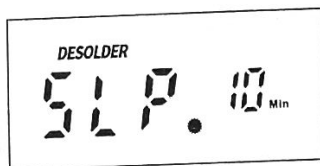

Graph 4

### Automatic Shutdown

1. Turn ON the desoldering station's power switch.
2. Press and hold the desoldering function button for approximately 2 seconds to enter the setting interface. Then quickly press the desoldering station function button 2 times to enter the automatic shutdown setting interface. The display will show value as shown in graph 5, with "02" blinking.
3. Press the desoldering station temperature increase or decrease button to set the automatic shutdown timer, then press the desoldering station function button to confirm.
4. Quickly press the desoldering station function button 2 times to exit the setting interface—setting complete.

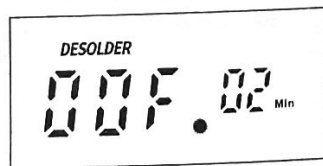

Graph 5

### Preset Channels (3 available channels – CH1/CH2/CH3)

#### 1. Hot Air Rework Station

Turn ON the power switch, then press the hot air rework station's function button to select the

desired preset channel. Set the respective temperature setting and air volume in the channel, then stop operating for approximately 5 seconds, and the setting will be saved in this channel.

#### 2. Desoldering/Soldering Station

Turn ON the power switch, then press the desoldering/soldering station function button to select the desired preset channel. Set the respective temperature setting, sleep mode timer, automatic shutdown timer, then stop operating for approximately 5 seconds, and the setting will be saved in this channel.

## IV. MAINTENANCE & PRECAUTIONS

### Soldering Station

1. If a layer of oxidization forms on the surface of the soldering iron tip, a misconception can be created that the tip cannot heat up properly to melt the solder and do the tinning. But the actual temperatures of both the heating element and tip are high. In such an instance, please do not increase the temperature value confusedly but use a metal wool ball to remove the oxidization following the steps below:
  - A. Set the temperature to 300°C (572°F).
  - B. Once the temperature stabilizes, gently rub the soldering iron tip inside the metal wool ball.
  - C. When the oxidization is partially removed, continue applying solder onto the soldering iron tip while rubbing it until the tip is completely coated with solder. If the tip is too severely oxidized beyond cleaning, replace it with a new one.
2. DO NOT use metal files to remove the oxidization on the soldering iron tip. If the soldering iron tip deforms or rusts, replace the soldering iron tip with a new tip.
3. DO NOT apply excessive force on the soldering iron tip when soldering. This will not only not improve the heat transfer but damage the soldering iron tip instead.
4. When placing the soldering iron back in the holder to idle after a high-temperature operation, adjust the temperature to 250°C (482°F) or below for idling. Failure to do so, and leaving the soldering iron tip to idle on a high-temperature setting will cause the accelerated aging of the heating element and shorten the lifespan of the heating element and soldering iron tip.
5. After every operation, clean the soldering iron tip, then tin the tip with a new layer of solder to prevent oxidization.

### Desoldering Station

1. The cleaning and maintenance procedures of the desoldering nozzle are identical to that of the soldering iron tip.
2. Cleaning methods of the nozzle, heating element, and filter tube.

### A. Nozzle Cleaning

- \* Plug the power plug into the power socket, and turn ON the power switch. Then set the temperature to 400°C/752°F.
- \* Once the temperature has stabilized, select the appropriate cleaning pin to clean the nozzle.

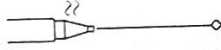

### B. Heating Element Cleaning

- \* Remove the fastener, nozzle enclosure, and nozzle once the heating element is cooled.
- \* Turn ON the desoldering station's power switch, and set the station to 400°C/752°F. Once the temperature is stabilized, select the cleaning pin of the appropriate size to clean the inner hole of the heating element.
- \* When done cleaning, turn OFF the power switch.

**CAUTION:** Cleaning MUST be carried out ONLY when the solder inside the inner hole is completely melted. If the cleaning pin CANNOT be put through the inner hole, you need to replace the heating element. When assembling, ensure the fastener is appropriately tightened. A loosely-tightened fastener will result in low nozzle temperature and poor thermal transfer.



### C. Filter Tube Cleaning

- 1) Turn OFF the power switch, and wait for the filter tube to cool before removing the tube as instructed by the below graph.

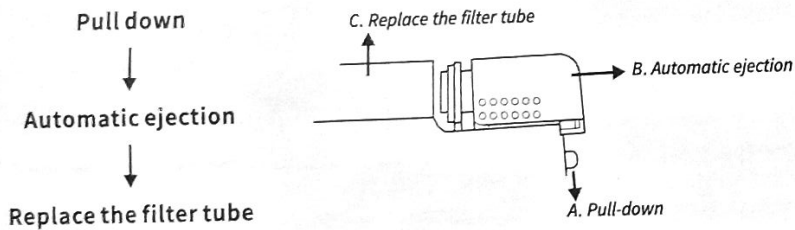

- 2) Disassemble the filter tube as per the illustration in the graph, and then remove the spring filter. Clean the solder off the spring filter.

**CAUTION:** The filter tube is extremely HOT, beware of burn injuries when cleaning.

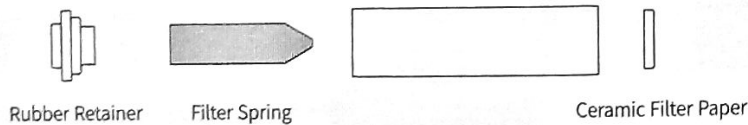

- Replace the filter tube if any of the following conditions occur:**
- \* The solder inside the filter spring CANNOT be removed, or the spring has accumulated scrap solder more than two-thirds of its total capacity. - you need to replace filter spring.
  - \* The rubber retainer is hardened or cracked - you need to replace the rubber retainer.
  - \* The ceramic filter paper has hardened due to an over-accumulation of solder scrap and flux - you need to replace the ceramic filter paper.

### 3. Heating Element Replacement

- ① DISCONNECT the power cord, and wait for the heating element to cool.
- ② Remove the fastener, steel tube and nozzle.
- ③ Remove the locking screw securing the heating element.
- ④ Remove the filter tube.
- ⑤ Remove the screws securing the casing, and open the gun's casing.
- ⑥ Remove the heating element's wirings, and extract the heating element.
- ⑦ Install the new heating element.
- ⑧ Connect the wires as per the original (factory) wiring order.
- ⑨ Assemble the desoldering gun in the reverse order of the disassembly, and perform the temperature calibration procedures..

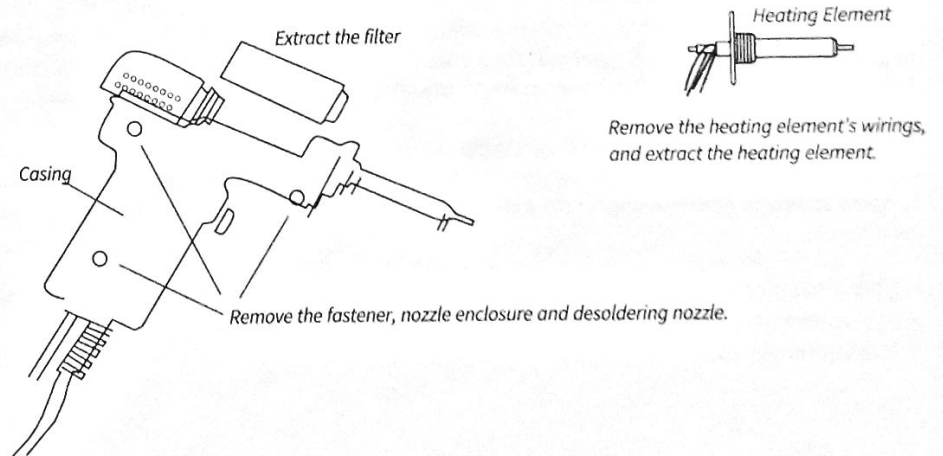
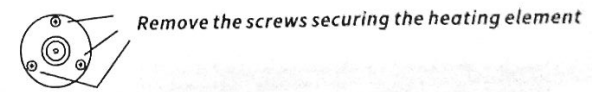
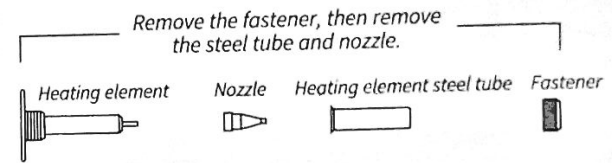

## Hot Air Rework Station

1. Keep the air outlet clear and free of blockages at all times.
2. The installation of the hot air gun nozzles **MUST** be carried out **ONLY** when the steel pipe and nozzle have cooled. Install the nozzle correctly, **DO NOT** install the nozzle with brute force, pull the edge of the nozzle with tweezers, or over-tighten the screws.
3. Select the appropriate nozzle based on your operation requirement (temperatures may vary when you use nozzles in different diameters). When using nozzles smaller than the stock nozzles, you **MUST** use the maximum air volume with a relatively lower temperature setting. Complete this operation in the shortest duration possible to prevent damaging the hot air gun.
4. Keep a minimum distance of 2mm between the subject and the hot air gun's air outlet.
5. **DO NOT** allow the hot air to come in direct contact with facial parts, and beware of the danger of burn injuries. Upon the first use, the hot air gun may emit white fumes, and the white fume will dissipate in a short while.

### NOTE:

The station's hot air gun and soldering iron handles use high-strength stainless steel tubes. The station goes through 4 times or more testing, inspection, and calibration procedures before rolling off the assembly line. The steel tube may exhibit light bronze color as a result of our quality control efforts. It is normal to have a slightly bronzed steel tube when you using a brand-new station; Rest assured for regular usage.

## V. TROUBLESHOOTING GUIDE

1. S-E – This is an indication that the station's sensor module is faulty. You need to replace the heating element (the heating element and the sensor modules). Or it may be that the handle has not been connected (Turn OFF the power, connect the handle, then turn ON the station again.)
2. Pht – This is an indication that the desoldering station is preheating the gun, and the vacuum pump is turned OFF by default. This is a protection function to prevent premature desoldering and to allow sufficient heating time for the entire desoldering mechanism to heat up to operating temperature.
3. F-1/F-2 – This is an indication that the station is detecting no air output released from the hot air gun, and the hot air gun is in the zero-air protection mode. You need to inspect the hot air gun and its power circuitry.

## VI. PARTS LIST (DESOLDERING GUN)

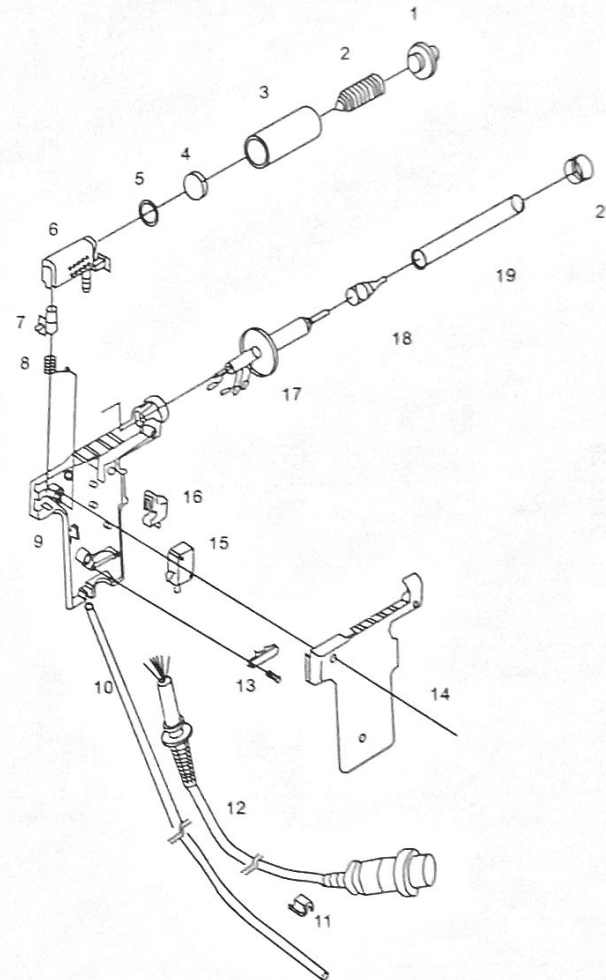

1. Rubber Retainer
2. Filter Spring
3. Filter Tube
4. Ceramic Filter Paper
5. Rubber Seal
6. Chamber
7. Release Button
8. Spring (Release Button)
9. Case (Bottom)
10. Vacuum Tube
11. S-Shaped Wire Coupler
12. Power Cord (Desoldering Gun)
13. Wire Clamp
14. Casing (Top)
15. Switch
16. Trigger
17. Heating Element
18. Desoldering Nozzle
19. Nozzle Enclosure
20. Fastener

## For reference: compatible parts

### Nozzle style (specifications and sizes)

The nozzles sizes match with their corresponding IC sizes.

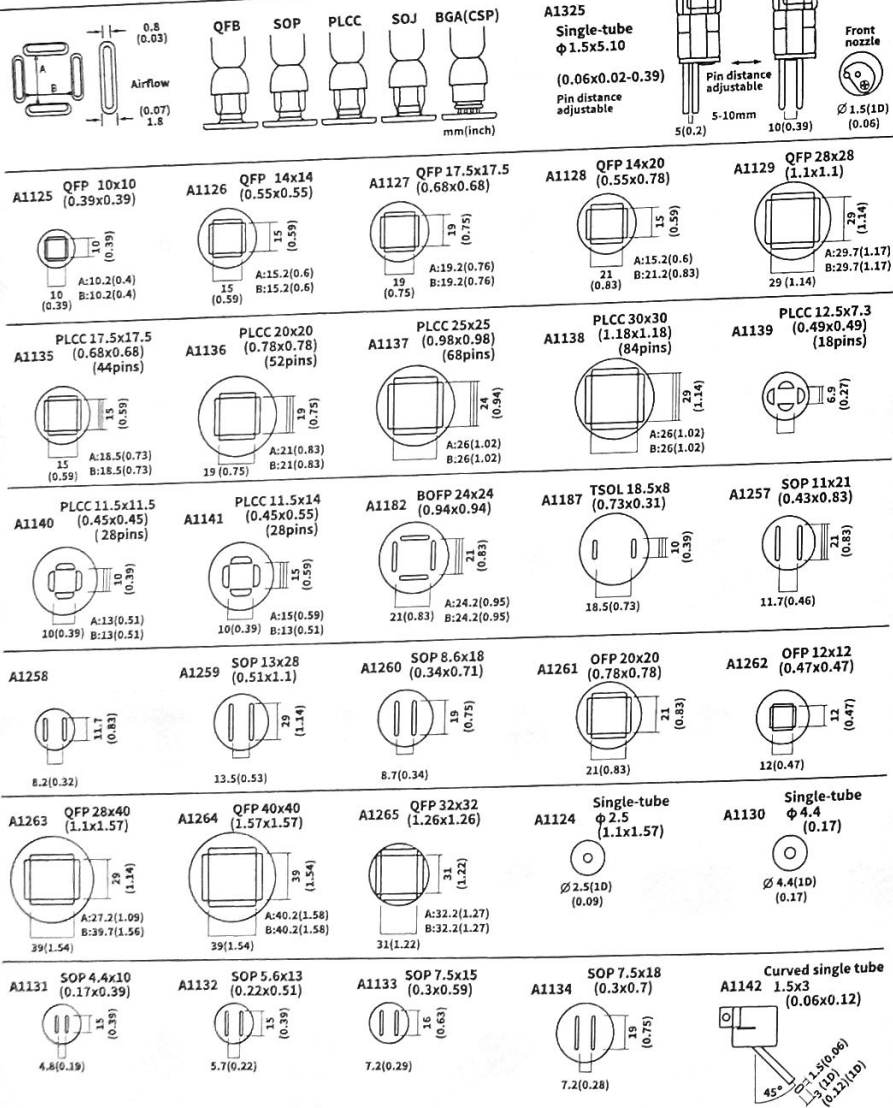

### Tip style (specifications and sizes)

900M Series Tip Out Diam Φ 6.5mm

